

# swissvoice

## Xtra 2355



### USER MANUAL

# QUICK SETUP

## 1. Set Language

After first time power up (base station is also connected to main power, for details, refer to Section 4). LANGUAGE? will appear on the screen.

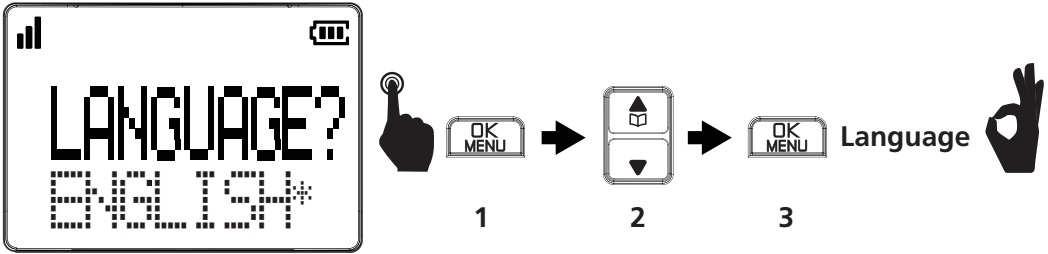

1. Press **OK** on the handset.
2. Press **▲** or **▼** to select the desired language.
3. Press **OK**. You hear confirmation tones and **OK** will appear on the screen.  
(For Duo or Trio version, you just set 1 of handsets, the other handset(s) will be changed accordingly)

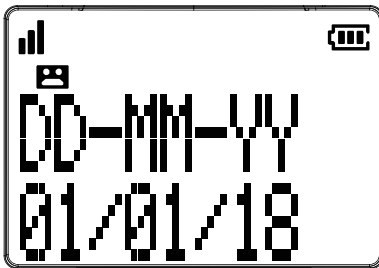

OR

1. Press **OK** on the handset in idle mode.
2. Press **▲** or **▼** to select **HS SETTING**, then press **OK**.
3. Press **▲** or **▼** to select **DATE&TIME**, then press **OK**.
4. Press **▲** or **▼** to select **SET DATE**, then press **OK**, Input the day, month, year, then press **OK**, input hour (24HR format), and minutes, then press **OK**, You hear confirmation tones.

Note: if digit is input wrong during input Date or Time, you can press **▲** or **▼** to select the right position and input correct digit.

# Package Contents of Xtra 2355

The package contains the following items:

- 1) Cordless handset
- 2) Cordless base unit
- 3) Mains power adaptor
- 4) Telephone line cord
- 5) Telephone plug convertor (optional)
- 6) 3pcs of AAA 500mAh NiMH rechargeable batteries
- 7) User Guides
- 8) 4 pcs of spare transparent photo covers

The additional duo and trio package contains the following items:

- Cordless Handset(s)
- Cordless handset charger(s)
- Mains power adapter(s)
- AAA 500mAh NiMH rechargeable batteries

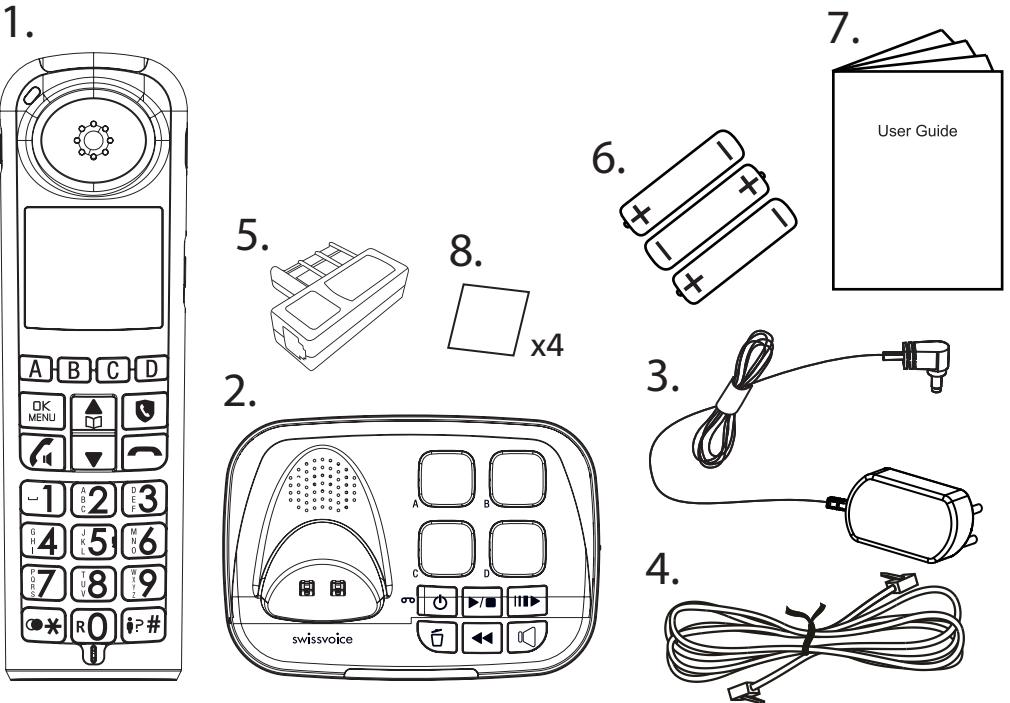

# Table of Content

<b>1.</b>	<b>IMPORTANT SAFETY INSTRUCTIONS</b> .....	<b>6</b>
<b>2.</b>	<b>LOCATION</b> .....	<b>7</b>
<b>3.</b>	<b>INSTALLING YOUR PHONE</b> .....	<b>7</b>
3.1.	Installing and Charging the Batteries .....	7
3.2.	Connecting the Base Station .....	8
<b>4.</b>	<b>GETTING TO KNOW YOUR PHONE</b> .....	<b>9</b>
4.1.	Handset Overview .....	9
4.2.	Base station Overview .....	12
4.3.	Display Icons and Symbols of LCD .....	14
<b>5.</b>	<b>MENU TREE</b> .....	<b>15</b>
<b>6.</b>	<b>USING YOUR PHONE</b> .....	<b>17</b>
6.1.	Set Date & Time and Language .....	17
6.1.1.	Set Date & Time .....	17
6.1.2.	Change language .....	17
6.2.	Make, Answer, End a Call .....	18
6.2.1.	Make a Call .....	18
6.2.1.1.	Preparatory Dialing .....	18
6.2.1.2.	Direct Dialing .....	18
6.2.1.3.	Call direct memories (A, B, C, D) on base or on handset .....	18
6.2.1.4.	Call the indirect memories (Key 1 to Key 9) .....	18
6.2.2.	Answer a Call .....	18
6.2.3.	End a Call .....	18
6.3.	Set Photo A, B, C, D key memories .....	19
6.3.1.	Input number and name .....	19
6.3.2.	Record your own voice tag .....	19
6.3.3.	Play Voice tag .....	19
6.3.4.	Delete Voice tag .....	19
6.3.5.	View record of Photo memory .....	20
6.3.6.	Edit record of Photo memory .....	20
6.4.	Adjust Earpiece and Handsfree Volume .....	20
6.5.	Audio Boost .....	20
6.6.	Equalizer .....	21
6.7.	Redial .....	21
<b>7.</b>	<b>PHONE SETTINGS</b> .....	<b>21</b>
7.1.	Set Ringer Melody and Volume .....	22
7.2.	Set Alert Tone .....	22

7.3.	Set Date and Time Format .....	23
7.4.	Talking Digit .....	23
7.5.	Change the Flash Time .....	23
7.6.	Reset Your Phone .....	23
7.7.	Registration .....	24
7.8.	Find the Handset .....	24
7.9.	Conference call .....	24
7.10.	Transfer a call .....	25
7.11.	Intercom .....	25
7.11.1.	Intercom initiated from cordless handset: .....	25
7.12.	Answer a Call .....	26
7.13.	Enrich Ring .....	26
<b>8.</b>	<b>CALLER DISPLAY (Network dependent) .....</b>	<b>26</b>
8.1.	View the call list .....	27
8.2.	Store a Call list Number into the Phonebook .....	27
8.3.	Store a Call list Number into the Black List .....	27
8.4.	Delete an entry in the call list .....	28
8.5.	Delete all entries in the call list .....	28
8.6.	Call waiting .....	28
8.6.1.	Using handset or speaker mode from the handset .....	28
8.7.	Voice Mail (Network Dependent) .....	28
<b>9.</b>	<b>PHONEBOOK .....</b>	<b>29</b>
9.1.	Add a new phonebook entry .....	29
9.2.	View a phonebook entry .....	29
9.3.	Search a phonebook entry .....	29
9.4.	Edit a phonebook entry .....	29
9.5.	Store phonebook in speed dial .....	29
9.6.	Delete a phonebook entry .....	30
9.7.	Add to speed dial key .....	30
9.8.	Status of phonebook .....	30
<b>10.</b>	<b>SPEED DIAL KEYS (Key 1 to Key 9) .....</b>	<b>30</b>
10.1.	Store a speed dial entry .....	30
10.2.	View a speed dial entry .....	31
10.3.	Edit a speed dial entry .....	31
10.4.	Delete a speed dial entry .....	31
<b>11.</b>	<b>CALL BLOCKER .....</b>	<b>33</b>
11.1.	Manual call block mode .....	33
11.1.1.	Enable manual mode .....	33
11.2.	Add numbers to Blocklist .....	33
11.3.	Edit numbers in Blocklist .....	34
11.4.	Delete numbers in Blocklist .....	34

11.4.1.	Delete a number from blacklist .....	34
11.4.2.	Delete all numbers from blacklist .....	34
12.	Automatic call block mode .....	34
12.1.	VIPs only .....	34
12.2.	Contacts only .....	34
13.	Anonymous call block mode .....	35
13.1.	Block Private Calls .....	35
13.2.	Block All Anonymous Calls .....	35
13.3.	Set Block Anonymous Calls OFF .....	35
14.	<b>REMINDER</b> .....	36
14.1.	Turn on alarm reminder, set time and frequency .....	36
14.2.	Select melody of the alarm reminder .....	36
14.3.	Rename the alarm reminder .....	36
14.4.	Record Voice memo of the alarm reminder .....	37
15.	<b>ANSWERING MACHINE</b> .....	37
15.1.	Turn on/off the answering machine .....	37
15.2.	Message Playback .....	38
15.3.	Delete Old Message in the Answering Machine .....	39
15.4.	Record a Memo .....	40
15.5.	Outgoing Message (OGM) .....	40
15.5.1.	Play your outgoing message (OGM) .....	40
15.5.2.	Record your own outgoing message (OGM) .....	41
15.5.3.	Delete your outgoing message (OGM) .....	41
15.6.	Answering Machine Settings .....	41
15.6.1.	Set Answer Delay .....	41
15.6.2.	Recording Time .....	41
1153.6.3.	Call Screening .....	42
15.6.4.	Activate Remote Access .....	42
15.6.5.	Message Alert Tone .....	43
16.	<b>TECHNICAL SPECIFICATIONS</b> .....	44
17.	<b>TROUBLESHOOTING</b> .....	45
18.	<b>GUARANTEE</b> .....	47
19.	<b>SAFETY</b> .....	49
20.	<b>ENVIRONMENT</b> .....	50

# 1. IMPORTANT SAFETY INSTRUCTIONS

When using your telephone equipment, basic safety precautions should always be followed to reduce the risk of fire, electric shock and injury, including the followings:

- 1) Read and understand all the instructions.
- 2) Follow all warnings and instructions marked on the product.
- 3) Unplug this product from the wall outlet before cleaning.  
Do not use liquid cleaners or aerosol cleaners. Use a damp cloth for cleaning.
- 4) **To avoid hearing damage, please make sure anyone who uses this product is aware that the product can produce loud sound when Audio boost function is on.**
- 5) Do not use this product near water (for example, near a bath tub, kitchen sink, swimming pool).
- 6) Do not expose the telephone to direct sunlight or extreme cold environment. Do not put the telephone close to a heating source such as radiators, cookers, etc.
- 7) Do not overload wall outlets and extension cords as this can result in the risk of fire or electric shock.
- 8) NEVER use your phone outdoors during a thunderstorm-unplug the base from the telephone line and the mains socket when there are storms in your area.
- 9) Do not use the telephone to report a gas leak in the vicinity of the leak.
- 10) **Use only the supplied NiMH (Nickel Metal Hydride) batteries!**  
The operation periods for the handsets are only applicable with the default battery capacities.
- 11) **The use of other battery types or non-rechargeable batteries/primary cells can be dangerous.**  
The manufacturer will not be held liable for damage arising from such noncompliance.
- 12) Do not use third party chargers. The batteries may be damaged.
- 13) Dispose of batteries safely. Do not immerse them in water, burn them, or put them where they could get punctured.

## 2. LOCATION

For maximum coverage and reduce the interference, here are some guidelines you should consider when you place the base unit,

- place it at a convenient, high, and central location with no obstructions between the handset and base unit in an indoor environment.
- place it away from electronic appliances such as televisions, microwave ovens, radios, personal computers, wireless devices or other cordless phones.
- avoid facing radio frequency transmitters, such as external antennas of mobile phone cell stations.
- avoid plugging it into the same circuit as other major household electrical appliances because of the potential for interference.  
Try moving the appliance or the base unit to another power outlet.

If the reception for a base unit location is not satisfactory, move it to another location for better reception.

Depending on the surrounding conditions as well as spatial and structural factors, the range may be reduced. The range indoors is normally less than outdoors.

## 3. INSTALLING YOUR PHONE

### 3.1. Installing and Charging the Batteries

- 1) Slide down to open the battery compartment cover.
- 2) Place the 3 supplied AAA-size NiMH rechargeable batteries as indicated. Pay extra attention to direction of polarity.

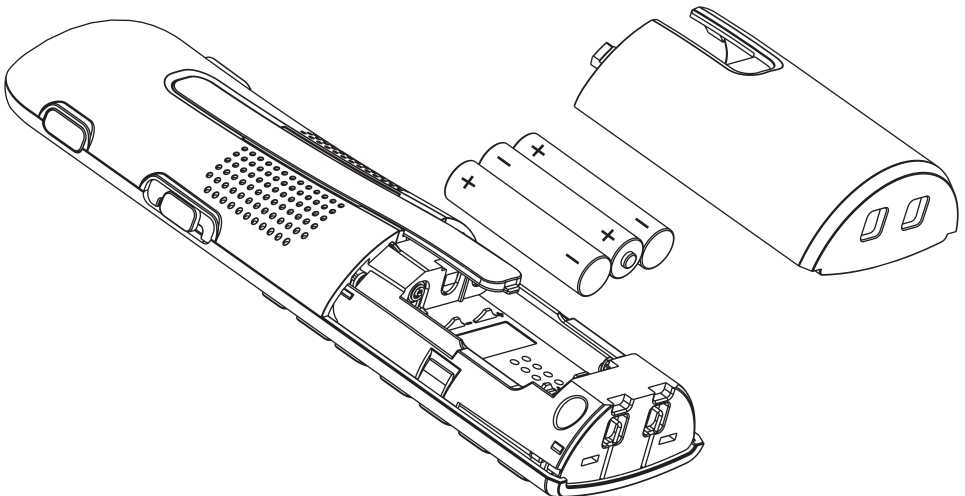



- 3) Slide the battery compartment cover back.
- 4) Put the handset on the base and charge for **15 hours** before using the handset for the first time.

**Notes:**

- 1) **Use only the supplied NiMH rechargeable batteries.**
- 2) If the handset will not be used for a long time, disconnect and remove the batteries to prevent possible leakage.

### 3.2. Connecting the Base Station

- 1) Plug one end of the telephone line cord into the telephone jack on base bottom.
- 2) Plug the small end of power adapter into a power jack on base bottom.
- 3) Plug the large end of power adapter into a wall power outlet.
- 4) Plug the other end of the telephone line cord in to the telephone jack or micro-filter.
- 5) Always use the cables provided in the box.

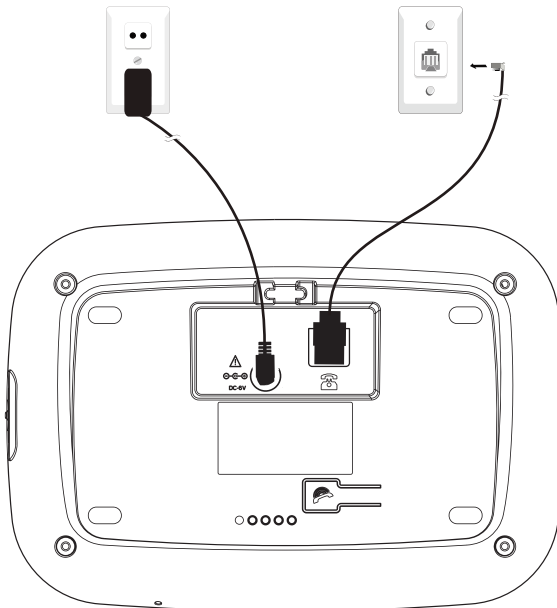

If you have a Broadband line

If you connect your telephone to a line with a broadband connection, you will need to insert a micro-filter between the telephone and the telephone line, otherwise you may get interference between the telephone and the broadband, which could cause problems.

In a fixed with broadband, every telephone must have a micro-filter connected, not just the one at the telephone point that your modem is connected to.

If you need more broadband micro-filters, contact your broadband supplier.

## 4. GETTING TO KNOW YOUR PHONE

### 4.1. Handset Overview

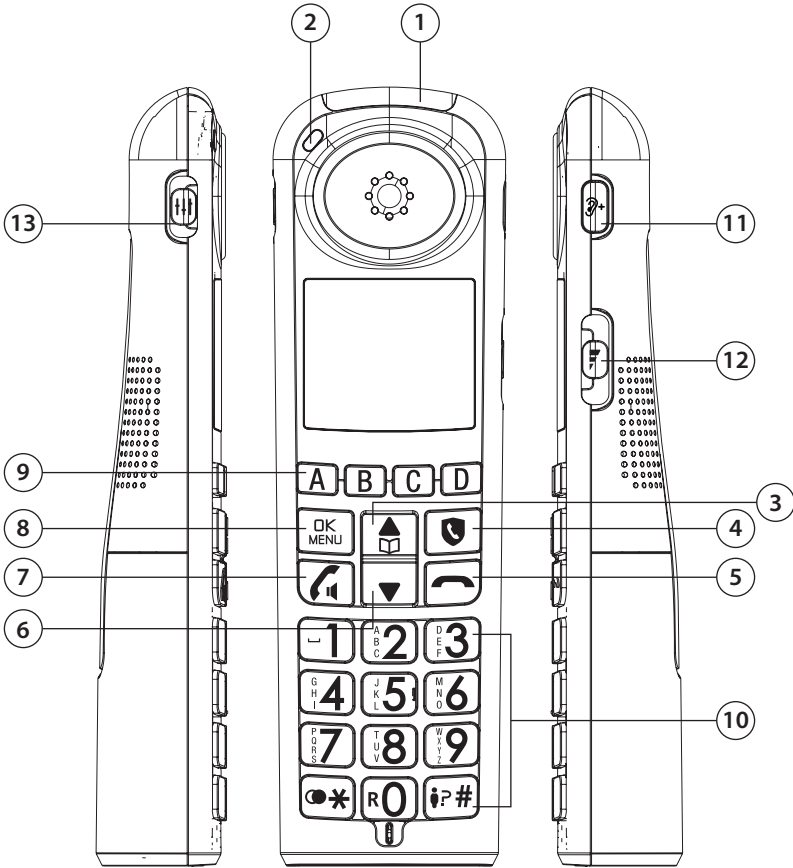

## 1 INCOMING CALL LED

- Flashes when there is an incoming call/ the base is paging the handset.

## 2 CHARGE LED

- On when the handset is charging in the charger or base.

## 3

- In menu mode: Press to scroll up the menu items.
- In ringing mode: Press to increase ringer volume of handset.
- While entering names or numbers in the phonebook:  
Press to move the cursor to the left.

## 4

- In idle mode: Press to access phonebook.

## 5

- During a call: Press to end a call and go back to idle screen.
- **In editing/predialing mode: Press to clear a character/digit.**
- **In menu/editing mode: Press and hold to go back to idle screen.**
- In ringing: Press to suppress handset ringer.

## 6

- In menu mode: Press to scroll down the menu items.
- In ringing mode: Press to decrease the ringer volume of handset.
- While entering names or numbers in the phonebook:  
Press to move the cursor to the right.

## 7

- In idle/pre-dialing mode: Press to make a call.
- During ringing: Press to answer a call.
- During a call: Press to turn on/off the speakerphone.

## 8

- Press to select a menu item.
- While in a menu: Press to select an item or save an entry or setting.

## 9 **A B C D**

- Press to dial out phone number stored in memory A, B, C, or D....

## 10 ALPHANUMERIC KEYPAD/ \* / #

- In idle / pre-dial / editing mode / during a call:  
Press to enter characters /numbers.
- Press any key to answer an incoming call.
- Press \* to switch between upper case and lower case while entering characters.
- During a call: Press and hold # to answer an incoming call when you receive at call waiting alert\*.

## 11

- Press to enhance the clarity and loudness through earpiece during a call.



**Warning: The product may emit high volume of sound. Take Extra Care when you use audio boost key, recommend you to adjust suitable volume by setting minimum, and then turn on audio boost key.**

## 12

- During a call: Press to increase the volume /decrease the volume.

## 13

- Sound experience: select "NATURAL", "BASS" or "TREBLE" during a call.



BASS (lowest position)



NATURAL (mid position)



TREBLE (highest position)

## 14

- In idle mode. Long press to access the redial list. Short press for star.
- In talk mode. Only for star (access to vocal server services).

## 4.2. Base station Overview

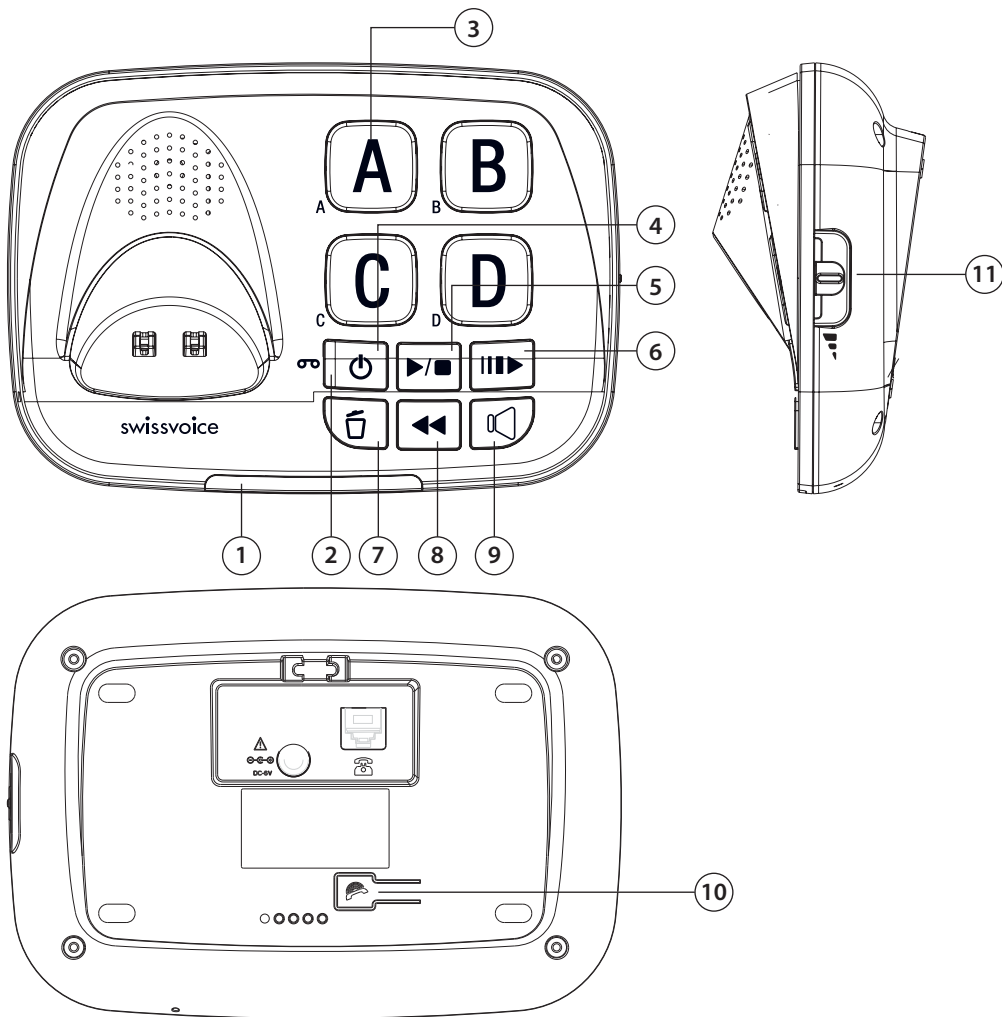

### 1 INCOMING CALL LED

- Flashes when there is an incoming call.
- On when there the phone is in use.
- On when a device is being registered.
- On when another telephone is in line on the same.

### 2 MESSAGE LED ( )

- On when the answering system is on.
- Flashes when there are new messages/memos in the answering system.
- Flashes slowly when pressing  for slow play.

### 3 DIRECT MEMORY KEYS (A, B, C, D)

- Press to dial out phone number stored.

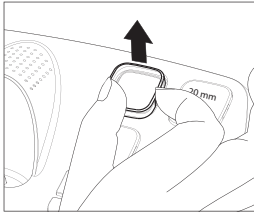

1

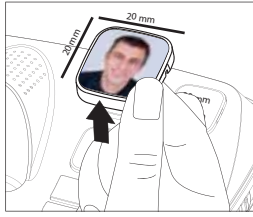

2

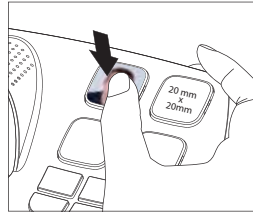

3

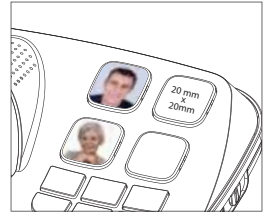

4

### 4 ◀◀

- Press to repeat playing the current message from the beginning.
- Press twice to skip backward to the previous message.

### 5 ▶/■

- Press to play the message.
- Press again to stop the message playback.

### 6 🗑️

- Press to delete the message currently playing.
- In idle mode, long press to delete all old messages.

### 7 🔌

- Press to turn on the answering machine.
- Press again to turn off the answering machine.

### 8 |||▶

- Press to slow down the message playback.

### 9 🔊

- Press to make, answer or end a call through base speaker.
- Orange LED is on during speaker mode.

### 10 📶

















- Press to page your handset. It will ring for approximately 60 seconds.

### 11 📶

- During a call: Slide up and down to increase the volume /decrease the volume.
- During message playback: Press to adjust the volume.

\*Subject to subscription and availability of the service from the fixed line operator.

### 4.3. Display Icons and Symbols of LCD

Display icons	Description
	Full battery power level.
	2/3 battery power level.
	1/3 battery power level.
	Flashes when the battery is low and needs charging.
	The speakerphone is in use.
	On: if the handset ringer is turned off.
	On: when there are received new Voice Message Waiting (VMWI) not yet read*. Disappear: when all the voice messages have been read. (Network service dependent)*
	 displays when there the signal strength is strong.  displays when there the signal strength is moderate.  displays when there the signal strength is weak. Off when handset is out of range from the base.
	On: New call list- Missed and new calls.
	On: The answering system (TAM) is turned on. Flashes: when new TAM message is received. Off: The answering system (TAM) is turned off.
	On: when an alarm is set. Off: when an alarm is off.
	On: when audio booster is activated (in earpiece mode). Off: when audio booster is deactivated.
	On: when the telephone line is in use. Flashes: when there is an incoming call.
	On: when the entry in call list is a contact saved in black list.

# 5. MENU TREE

MAIN MENU	Level 1	Level 2	Level 3	Level 4	Level 5	
<b>Call List</b>	FIRST ENTRY	View				
	....	Add To PB	VIP X			
			VIP Y			
	LAST ENTRY	Add To Block				
		Delete	Confirm?			
		DeleteAll	Confirm?			
<b>Phonebook</b>	All	FIRST ENTRY	Add new	Number	Name	
		....	View			
		LAST ENTRY	Edit	Name	Number	
			Delete	Confirm?		
			DeleteAll	Confirm?		
			Add to SD	KEY 1		
				KEY 2		
				....		
				KEY 9		
		Dial	Key 1	Add new	Number	Name
			Key 2	View		
		....	Edit			
		KEY 9	Delete	Confirm?		
<b>Call Block</b>	Block Set	Off *	Saved			
		On	Saved			
		VIP OK	Saved			
		Contacts OK	Saved			
	Blocklist	FIRST ENTRY	Add new	Number	Name	
		....	View			
		LAST ENTRY	Edit			
			Delete	Confirm?	Deleted	
			Delete All	Confirm?	Deleted	
			Status	Used		
	Block Anonym	Off *	Saved			
	Private	Saved				
	All	Saved				
<b>Direct Mem.</b>	A	Add new	Number	Name		
	..B..C..D	Voice Tag	Playback	Playing		
			Delete	Deleted		
			Record	Recording		
		View				
	Edit	Number	Name			
	Delete	Confirm?				
<b>Ans.Machine</b>	MSG Playback					
	Delete All	Confirm?				
	Memo	Recording				
		Playing				
	Tam On/Off	off *				
		On				
	OGM	Ans & Rec *	Play OGM	Playing		
			Rec. OGM	Recording		
			Delete	Deleted		
		Answer Only	Play OGM			
			Rec. OGM	Recording		
			Delete	Deleted		
	Answer Mode	Ans & Rec *				
		Answer Only	Play OGM			
Tam Settings	BS Screening	Off *				
		On				
	Answer Delay	Rings 2				
		Rings 4				
		Rings 6 *				
		Rings 8				
		Rings 10				
	Record Time	60 s *				
		120 s				
		180 s				
	Remote Acc.	Off *				
		On				
	Change Pin	PIN?				
	Msg Alert	Off *				
		On				



		Language	English *		
			Francais		
			Deutsch		
			Italiano		
			Nederlands		
			Espanol		
			Portugues		
<b>HS Setting</b>	Ring Setup	Ext.Ring	Melody 1		
			Melody 2 *		
			.....		
			Melody 12		
		Int.Ring	Melody 1		
			Melody 2		
			Melody 3 *		
			.....		
			Melody 12		
		Ring Volume	Volume 1 *		
			.....		
			Ring Off		
	Tone Setup	Key Tone	On *		
			Off		
		Batt. Tone	On *		
			Off		
		Out Of Area	On		
			Off *		
	Language	English *			
		Francais			
		Deutsch			
		Italiano			
		Nederlands			
		Espanol			
		Portugues			
	Date / Time	Date Format	DD-MM-YY *		
			MM-DD-YY		
		Time Format	24 HR *		
			12 HR		
		Set Time	Set Date		
	Auto Answer	On *			
		Off			
	Registration	Registration			
	Delete Hs	1			
	Default	Confirm?			
<b>BS Setting</b>	BS Ringer	Melody 1			
		Melody 6 *			
		.....			
		Melody 12			
	Ring Vol	Volume 1			
		.....			
		Volume 5			
		Off *			
	Enrich Ring	On *			
		Off			
	Flash Time	Short *			
		Medium			
		Long			
	Dial Mode	Tone *			
		Pulse			
<b>Talk Digit</b>	On/Off	On *			
		Off			
<b>Reminder</b>	ALARM 1	On/Off	ON	Frequency	Once
	...ALARM 10		Off	Saved	Daily
					Mon-Fri
					Sat- Sun
		Melody	Melody 1		
			....		
			Melody 12		
		Rename			
		Voice Tag	Playback	Playing	
			Record	Recording	
			Delete	Deleted	
<b>Intercom</b>	Base				

## 6. USING YOUR PHONE

### 6.1. Set Date & Time and Language

#### 6.1.1. Set Date & Time

1. Input Date, Time directly after first time power up

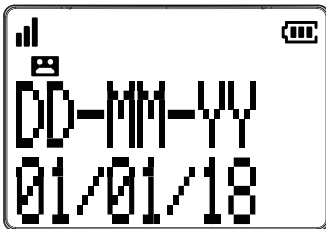

OR

1. Press **OK** on the handset in idle mode.
2. Press **▲** or **▼** to select **HS SETTING**, then press **OK**.
3. Press **▲** or **▼** to select **DATE&TIME**, then press **OK**.
4. Press **▲** or **▼** to select **SET DATE**, then press **OK**, Input the day, month, year, then press **OK**, input hour (24HR format), and minutes, then press **OK**, You hear confirmation tones.

Note: if digit is input wrong during input Date or Time, you can press **▲** or **▼** to select the right position and input correct digit.

#### 6.1.2. Change language

1. Press **OK** on the handset in idle mode.
2. Press **▲** or **▼** to select **HS SETTING<sup>(1)</sup>**, then press **OK**.

(1)

EN	FR	DE	IT	NL	ES	PT
HS SETTING	REGL. COMB	MT-EINSTEL	IMP PORTAT	HS INST.	CONF SUPL	CONF TERM

3. Press **▲** or **▼** to select **LANGUAGE<sup>(2)</sup>**, then press **OK**.

(2)

EN	FR	DE	IT	NL	ES	PT
LANGUAGE	LANGUE	SPRACHE	LINGUA	TAAL	IDIOMA	IDIOMA

4. Select the desired language and press **OK**. You hear confirmation tones.

Notes:

1. Base station has to be connected with AC mains during setting.
2. When language is changed, texts of LCD screen, talking digit, and default outgoing message of answering machine will be changed accordingly.

## 6.2. Make, Answer, End a Call

### 6.2.1. Make a Call

#### 6.2.1.1. Preparatory Dialing

Handset: Enter the phone number and press  to dial the number.

Press  to clear the entry.

#### 6.2.1.2. Direct Dialing

Handset: Press  to take the line and enter the phone number.

#### 6.2.1.3. Call direct memories (A, B, C, D) on base or on handset

To call in handsfree mode: press again

"On hook key" during dialling or during conversation.

To stop handsfree mode, press again "On hook key"

Press A, B, C, D key on handset or Photo A, B, C, key on base to dial.

**Note:** Before dialing, programming of A, B, C, D keys is required, refer to Section 6.3.

#### 6.2.1.4. Call the indirect memories (Key 1 to Key 9)

Long press Key 1, or, ....Key 9 on the handset to dial.

**Note:** Before dialing, programming of key 1, ...key 9 is required, refer to Section 9.5.

### 6.2.2. Answer a Call

Using Cordless Handset:

If the handset is not on the charging cradle, when the phone rings, press  .

Using Telephone Base:

Press  to answer a call. The handsfree mode will be activated.

### 6.2.3. End a Call

During a call connection,

Using Cordless Handset:

Press  OR put the handset on the charging cradle to end a call.

Using Telephone Base:

Press  to end a call.

## 6.3. Set Photo A, B, C, D key memories

### 6.3.1. Input number and name

1. Press **OK** on the handset in idle mode.
2. Press **▲** or **▼** to select **DIRECT MEM**, then press **OK**.
3. Press **▲** or **▼** to select **A, B, C, D**, then press **OK**.
4. Select **ADD, ,** then press **OK** , enter the telephone number, then enter his/her name, then press **OK** . You hear confirmation tones.

Note: during entering number or name, you can correct a number or a letter by pressing  , then last number or letter will be removed.

### 6.3.2. Record your own voice tag

This feature requires a subscription of Caller Line Identification service from your telephone service provider.



This feature is VERY convenient to know who calls you if his/her telephone number is stored and voice is recorded in 1 of 4 photo keys.

You can program telephone number and record your voice through the handset.

For other operations, they are controlled through the handset only.

1. Continue section 6.3.1.1., press **OK** .
2. **VIEW** appears, press **▲** or **▼** to select **VOICE TAG**, then press **OK** .
3. Press **▲** or **▼** to select **RECORD**, then press **OK**.
4. **RECORDING...** will appear, then you can speak (better with louder voice) after beep tone in front of handset microphone area (near key 0).
5. Press **OK** to finish recording.
6. Your recorded voice will be playback automatically.

Note: 15 seconds approx. recording time per memory.

When calling number matched to photo A, B, C, D, ringing sound with recorded voice will be announced from handset and base until you press  on handset or  on base to answer.

### 6.3.3. Play Voice tag



1. Press **OK** on the handset in idle mode.
2. Press **▲** or **▼** to select **DIRECT MEM**, then press **OK**.
3. Press **▲** or **▼** to select **A, B, C, D**, then press **OK**.
4. **VIEW** appears, then press **▲** or **▼** to select **VOICE TAG**, press **OK** .
5. **PLAY** appears, then press **OK**.
6. **PLAYING VOICE TAG...** will appear. The recorded voice will be playback.

### 6.3.4. Delete Voice tag

1. Repeat the step 1 to 4 in Section 6.3.1.3.
2. **PLAY** appears, then press ▲ or ▼ to select **DELETE**, press **OK**.
3. **RESET TO DEFAULT** will display. You hear confirmation tones.



### 6.3.5. View record of Photo memory

1. Press **OK** on the handset in idle mode.
2. Press ▲ or ▼ to select **DIRECT MEM**, then press **OK**.
3. Press ▲ or ▼ to select **A, B, C, D**, then press **OK**.
4. **VIEW** appears, then press **OK**.
5. Record (name and number) will show.

Press  to return previous menu or long press  to return to standby mode.

### 6.3.6. Edit record of Photo memory

1. Press **OK** on the handset in idle mode.
2. Press ▲ or ▼ to select **DIRECT MEM**, then press **OK**.
3. Press ▲ or ▼ to select **A, B, C, D**, then press **OK**.
4. **VIEW** appears, then press ▲ or ▼ to select **EDIT**, then press **OK**,
5. Edit number, then press **OK**.
6. Edit name, then press **OK**.

Press  to return previous menu or long press  to return to standby mode.

Note: during entering number or name, you can correct a number or a letter by pressing , then last number or letter will be removed.

## 6.4. Adjust Earpiece and Handsfree Volume

There are 6 levels to choose from for earpiece volume in Cordless handset and handsfree volume, through volume slide switch (refer to Section 4.1 and 4.2).

During a call:

Using Cordless Handset:

Slide up and down  to select volume 1-6.

The current setting is shown in LCD.

Using telephone base:

Slide left and right  to select volume 1-6.

## 6.5. Audio Boost

Use the audio boost feature to enhance the clarity and loudness of your caller's voice on the cordless handset earpiece when you are listening to a message or an announcement.

### To turn on Audio Boost:

While you are on a call or listening to a message or an announcement using the handset earpiece.

Using cordless handset, press + on side of handset.

To turn off Audio Boost:

Press + on side of handset again.

Note: Audio boost function will be off after end of call.



**Warning: The product may emit high volume of sound. Take Extra Care when you use audio boost key, recommend you to adjust suitable volume by setting minimum, and then turn on audio boost key.**

## 6.6. Equalizer

The equalizer feature on the handset enables you to change the quality of the handset audio to best suit your hearing.





During a call:

1. Slide up and down  on handset to select Treble, Natural, or Bass. (refer to Section 4.1 item 13 for details).





## 6.7. Redial

Each Cordless handset stores the last 10 dialled numbers (up to 17 digits each) in the redial list. The redial entries are not shared by all the system handsets.

In idle mode:

1. Press  and hold for 1 second.
2. Press  or  repeatedly to browse the list. The handset beeps twice at the end of the list.
3. When the desired entry displays, press  to dial.

During a call:

1. Press  .
2. Press  or  repeatedly to browse the list. The handset beeps twice at the end of the list.
3. When the desired entry displays, press  to dial.

## 7. PHONE SETTINGS

Before phone settings, the base station has to be connected to AC mains.

### 7.1. Set Ringer Melody and Volume

Set Handset ringer:

During ringing,

- Press ▲ or ▼ in the handset to adjust ringer volume of handset

OR

1. Press **OK** on the handset in idle mode.
2. Press ▲ or ▼ to select **HS SETTING**, then press **OK**.
3. Select **RING SETUP** by pressing **OK**.
4. Press ▲ or ▼ to select **EXT. RING**, **INT. RING** or **RING VOL**, then press **OK**,
5. After selection, press **OK** to confirm setting. You hear confirmation tones.

Set Base ringer:

1. Press **OK** on the handset in idle mode.
2. Press ▲ or ▼ to select **BS SETTING**, then press **OK**.
3. Repeat step 3 to step 5 of the above section.

Notes:

**EXT. RING** means ring tone (total 10 for handset, 5 for base) will ring when external call.

**INT. RING** means ring tone (total 10 for handset, 5 base) will ring when internal call (between base and handset, or among 2 or more handsets registered to the base).

**RING VOL** is **OFF**, **VOLUME 1** to **VOLUME 5**.

When the telephone is ringing, you can temporarily set silence for the ringer of the handset by pressing  only without disconnecting the call.

The next call rings normally at the preset volume.

### 7.2. Set Alert Tone

You can turn on the alert tone in the cordless handset when low battery/out of range is detected and key tone can be on or off.

1. Press **OK** when idle.
2. Press ▲ or ▼ to select **HS SETTING**, then press **OK**.
3. Press ▲ or ▼ to select **tone SETUP** then press **OK**.
4. Press ▲ or ▼ to select **KEY TONE**, **BATT TONE**, or **RANGE TONE**, then press **OK**.
5. Press ▲ or ▼ to select **ON** or **OFF**, then press **OK**.

You hear confirmation tones.

### 7.3. Set Date and Time Format

1. Press **OK** when idle.
2. Press **▲** or **▼** to select **HS SETTING**, then press **OK**.
3. Press **▲** or **▼** to select **DATE&TIME** then press **OK**.
4. Press **▲** or **▼** to select **DATE FORM**, then press **OK** , select your desired date format (**DD-MM-YY** or **MM-DD-YY**), OR
5. Press **▲** or **▼** to select **TIME FORM**, then press **OK** , select your desired time format (**24 HR** or **12HR**).
6. Press **OK** to confirm. You hear confirmation tones.

### 7.4. Talking Digit

You can turn on or off the audible spoken tone that is spoken when you press the dialing key on handset during predialing during a call.

1. Press **OK** when idle.
2. Press **▲** or **▼** to select **TLK DIGITS**, then press **OK** to select **ON** or **OFF**.
3. Press **OK** to confirm. You hear confirmation tones.

Note: spoken language of talking digit is same as what language has been in selected Section 6.1.2.

### 7.5. Change the Flash Time

1. Press **OK** when idle.
2. Press **▲** or **▼** to select **BS SETTING**, then press **OK**.
3. Press **▲** or **▼** to select **FLASH TIME**, then press **OK**.
4. Press **▲** or **▼** to select your desired flash time. (**Short, Medium, Long** are for your selection), then press **OK** to confirm. You hear confirmation tones.

### 7.6. Reset Your Phone





You can reset your phone to the default settings by using handset. After reset, all your personal settings will be deleted and resumed to default factory settings, but your phonebook and other memories remain unchanged except redial list.

1. Press **OK** when idle.
2. Press **▲** or **▼** to select **HS SETTING**, then press **OK** .
3. Press **▲** or **▼** to select **DEFAULT**, then press **OK** , **CONFIRMED?** Is displayed, then press **OK** to confirm. You hear confirmation tones.



## 7.7. Registration

Your handset and telephone base is pre-registered. If for some reason, the handset is not registered to the base station, **PUT ON BS TO POWER** will be displayed on the handset screen. If it is out of base and  disappears on the screen, register your handset according to the following procedure.

1. Make sure the handset is out of the base and shows **PUT ON BS TO POWER** before you begin registration.
2. Press and hold  on the telephone base in idle mode for around 5 seconds until incoming call light LED bar lits on the telephone base.
3. Press **OK** when idle.
4. Press  or  to select **HS SETTING**, then press **OK**.
5. Press  or  to select **REGISTER**, then press **OK**, **REGISTRNG** appears and flashes on the screen until the handset can be registered with base.

If registration fails, the telephone base screen displays **PUT ON BS TO POWER**.

Pls. repeat the above procedure.

## 7.8. Find the Handset

You can locate the handset by pressing  once on the paging key, located under the main base.

All the handsets registered to the base will produce the paging tone and **"PAGING"** is displayed on the LCD of the handsets.



You can stop the paging by pressing , , on any handset or  on the base again.

Note: If there is an incoming call during paging, the phone will ring with the incoming call instead of paging.



## 7.9. Conference call

Up to 5 cordless handsets and the telephone base can join an external call at the same time.

To join a call with a cordless handset:

- Press  join the call.
- Press  or place the handset in the base or charger to exit the call.

To join a call with the telephone base:



- Press  to join the call,
- Press  again, to exit the call.

## 7.10. Transfer a call

During an external call, you can transfer the call from a cordless handset or the telephone base to another system device.

To transfer a call from a cordless handset:

During a call,

1. Press **OK**, then press **▲** or **▼** to select **INTERCOM**, then press **OK**.
2. If you have two or more cordless handsets, press **▲** or **▼** to select the desired device and then press **OK**.
3. The external call is put on hold and the cordless handset shows **CALLING HS 2** or **CALLING BASE** destination device rings.
4. To answer the call on the destination handset, press, , or any dialing key, **OR**,  
To answer the call on the base, press **■** (speaker mode).
5. Press  on the calling handset to transfer the call to extra handset or base.

To transfer a call from the telephone base:

During a call,



1. If the handset(s) is put in base or charger, just take it away from cradle, the call will be transferred from base to handset automatically.
2. If handset(s) is out of base or charger, press  to start conference call among base and external call.  
Then, press **■** on the base to transfer the call to the handset.

## 7.11. Intercom

Use the intercom feature for conversations between two cordless handsets or between cordless handset and base.

In idle mode,

### 7.11.1. Intercom initiated from cordless handset:

1. Press , and then press **OK**, then press **▲** or **▼** to select **INTERCOM**, then press **OK**.
2. If you have two or more cordless handsets, press **▲** or **▼** to select the desired device and then press **OK**.
3. The cordless handset shows **CALLING HS 2**, the destination device rings.
4. To answer the call on the destination handset, press, , or any dialing key,

**OR**, To answer the call on the base, press **■** (speaker mode).

## 7.12. Answer a Call

If the handset is not on the charging cradle:

When the phone rings, press  to answer a call.

If the handset is on the base station and if **AUTO ANSWER** is set to ON:

When the phone rings, pick up the handset to answer a call.

1. Press **OK** when idle.
2. Press **▲** or **▼** to select **HS SETTING**, then press **OK**.
3. Press **▲** or **▼** to select **AUTO ANS.**, then press **OK**.
4. Press **▲** or **▼** to select **ON**.
5. Press **OK** to confirm. You hear confirmation tones.

## 7.13. Enrich Ring

When first call is not picked up and the same caller calls again within 5 minutes, the ringer level of handset and base will be automatically set to maximum, in order to alert elderly people or people who may be far from the telephone aware of the phone that is ringing.

1. Press **OK** on the handset in idle mode.
2. Press **▲** or **▼** to select **BS SETTING**, then press **OK**.
3. Press **▲** or **▼** to select **FORCED**, then press **OK** to select **ON**.
4. Press **OK** to confirm. You hear confirmation tones.

If disable Forced ringer feature.

1. Repeat the above item to 1 to 2.
2. Press **▲** or **▼** to select **FORCED**, then press **OK** to select **OFF**.
3. Press **OK** to confirm. You hear confirmation tones.



## 8. CALLER DISPLAY (Network dependent)

This feature is available if you have subscribed the Caller Line Identification service with your telephone service provider.

Your phone can store up to 30 received calls with date/time information in the Call List. The number will be shown on the LCD when the phone is ringing. If the number matches with one of the entries in your Private Phonebook, the caller's name stored in the private phonebook will be displayed with the number.

If the caller number is disabled to send caller information, **UNAVAIL** will display.

If the caller number is not provided, **PRIVATE** will display.



In standby, if three unanswered calls with different calling number are received, “**3 NEW CALLS**” will be displayed. Each time you review a call list entry marked with  icon, the number of new calls decreases by one. When you have reviewed all the new calls, the  icon no longer shows.

If the incoming telephone number matches the last 7 digits of a telephone number in your phonebook, the name that appears on the screen matches the corresponding name in your phonebook.

## 8.1. View the call list

All received calls are saved in Call List with the latest call putting at the top of the list. When the call list is full, the oldest call will be replaced by a new call. The latest call log is stored only when it is same calling number. When number of digits of incoming number is more than 10, it will show first 9 digits in first page, then, you can press **\*** key to view all digits.

In idle mode,

1. Press **OK**, then press **▲** or **▼** to select **CALL LOG**, then press **OK** to review the calling number display history.
2. Press **▲** or **▼** to browse the call log.
3. Press **OK**, **DETAILS** will show..
4. Press **OK** to view the details of the call log including date and time. (Date/Month and Time appears in left and right sides of lower row respectively)
5. Press  to return previous menu or long press  to return to standby mode.

## 8.2. Store a Call List Number into the Phonebook

1. Select a desired entry in the call list, and then press **OK**.
2. Press **▲** or **▼** to select **ADD TO PB**, and then press **OK**.
3. **Call number** appears press **OK** to confirm.
4. **Call name** appears if there is blank name, you can add the name.
5. Press **OK** to confirm. You hear confirmation tones.

## 8.3. Store a Call List Number into the Black List

1. Select a desired entry in the call list, and then press **OK**.
2. Press **▲** or **▼** to select **ADD TO BL**, and then press **OK**.
3. **Call number** appears press **OK** to confirm.
4. **Call name** appears if there is blank name, you can add the name.
5. Press **OK** to confirm. You hear confirmation tones.

## 8.4. Delete an entry in the call list

1. Select a desired entry in the call list.
2. Press ▲ or ▼ to select **DELETE**, and then press **OK**.
3. **CONFIRM?** appears press **OK** to confirm. You hear confirmation tones.

## 8.5. Delete all entries in the call list

1. Select a desired entry in the call list.
2. Press ▲ or ▼ to select **DELETE ALL**, and then press **OK**.
3. **CONFIRM?** will show, Press **OK** to confirm. You hear confirmation tones.

## 8.6. Call Waiting

You hear a tone in the handset earpiece if someone calls while you are already on a call.

### 8.6.1. Using handset or speaker mode from the handset

- Long press **#** key on cordless handset to put your current call on hold and take the new call.
- Long press **#** key on cordless handset to switch back and forth between calls.

## 8.7. Voice Mail (Network Dependent)

By subscription to your operator, you can have your calls diverted to a voicemail box when you are absent. For more details, contact your operator.

When new messages are received,  appears on the screen. The  disappears once you have consulted the voicemail messages.

**To reset the voicemail indicator:**

1. Press **OK** to select **CALL LOG**.
2. Press ▲ or ▼ to select Voice Mail log.
3. Long Press key 4, and then  should disappear.

## 9. PHONEBOOK





The phonebook stores up to 100 entries, which are shared by all handsets.

### 9.1. Add a new phonebook entry





In idle mode,



1. Press  or,
2. Press , press  to select **PHONEBOOK**, then press  to select **ALL**, press .



3. Press , **ADD** appears press .
4. Enter a telephone number, press .
5. Enter a name, then press . You hear confirmation tones.

### 9.2. View a phonebook entry





1. Select a desired entry in the phone book, and then press .
2. **ADD** appears then press  or  to select **VIEW**, press  to review name and number of the entry.

Press  to return previous menu or long press  to return to standby mode.

### 9.3. Search a phonebook entry







1. Follow the steps in View a phonebook entry above to enter the phonebook.
2. Enter the first character of the name to search.

### 9.4. Edit a phonebook entry

1. Select a desired entry in the phone book, and then press .
2. **ADD** appears then press  or  to select **EDIT**, press  to edit the number.
3. Press  to edit the name. You hear confirmation tones.

Note: during entering number or name, you can correct a number or a letter by pressing , then last number or letter will be removed.

### 9.5. Store phonebook in speed dial

1. Select a desired entry in the phone book, and then press .
2. **ADD** appears then press  or  to select **ADD TO SD**, press .
3. Press  or  to select **KEY 1** to **KEY 9**.
4. Press  to confirm. You hear confirmation tones.

## 9.6. Delete a phonebook entry

1. Select a desired entry in the phone book, and then press **OK**.
2. **ADD new** appears then press **▲** or **▼** to select **DELETE**, press **OK**.
3. **CONFIRM?** will display, press **OK** to confirm. You hear confirmation tones.

## 9.7. Add to speed dial key

1. Select a desired entry in the phone book, and then press **OK**.
2. **ADD** appears then press **▲** or **▼** to select **ADD TO SD**, press **OK**.
3. Press **▲** or **▼** to select **KEY 1, ... KEY 9**, press **OK** to confirm. You hear confirmation tones.

## 9.8. Status of phonebook

You can view how many phonebook records are stored out of total 100 records.

1. Press **☰**, press **OK**.
2. **ADD** appears then press **▲** or **▼** to select **STATUS**, press **OK**.
3. **X / 100 USED** will display.

## 10. SPEED DIAL KEYS (KEY 1 TO KEY 9)

You can make use of key 1 to key 9 on handset as speed dial keys, by long pressing it to dial in idle mode or in talk mode.

### 10.1. Store a speed dial entry



1. Press **OK**, press **▼** to select **PHONEBOOK**, then press **OK**.
2. Press **▼** to select **SPEED DIAL**, press **OK**.



3. Press **▲** or **▼** to select **KEY 1, ... KEY 9**, then press **OK**.
4. **ADD** will display, then press **OK**.
5. Enter a number, then press **OK**.
6. Enter a name, then press **OK**. You hear confirmation tones.
7. Press **☰** to return previous menu or long press **☰** to return to standby mode.

## 10.2. View a speed dial entry

1. Repeat the step 1 to 3 in Section 10.1.
2. **VIEW** will display, then press **OK**.
3. The record (number and name) can be viewed.

Press  to return previous menu or long press  to return to standby mode.

## 10.3. Edit a speed dial entry

1. Repeat the step 1 to 3 in Section 10.1.
2. **VIEW** will display, then press **▲** or **▼** to select **EDIT**, then press **OK**.
3. Edit a number, then press **OK**.
4. Edit a name, then press **OK**. You hear confirmation tones.

Note: during entering number or name, you can correct a number or a letter by pressing , then last number or letter will be removed.

## 10.4. Delete a speed dial entry

1. Repeat the step 1 to 3 in Section 10.1.
2. **VIEW** will display, then press **▲** or **▼** to select **DELETE**, then press **OK**.
3. **CONFIRM?** will display, then press **OK**. You hear confirmation tones.



# 11. CALL BLOCKER

This telephone is built-in with Smart Call Block feature\*. This feature will help you avoid nuisance calls by only allowing some numbers to make your phone ring. Default setting of Smart Call Block in this telephone is OFF but you can enable it via your phone settings, as explained in the following paragraphs.

*\*This feature requires a subscription of Caller Line Identification service from your telephone service provider.*

## Call block overview

Settings	Explanations
Off	Call Block function (Block all call with numbers) is Disabled. This is the default mode.
On	Call Block function is set to Manual. Numbers registered in the black list will not go through and the phone will ring silently. Numbers can be added to the list while the phone is ringing and / or after a call (to enable, see part 11.1).
Contacts	In this automatic mode, any number not registered to your phonebook will be automatically be blocked and not cause your phone to ring. All calls from contacts registered to your phonebook will proceed normally. When this mode is chosen, Contacts OK is displayed on LCD in idle mode unless you have unread messages/missed calls (to enable, see part 11.2.2).
VIPS	In this second automatic mode, only calls from contacts registered as VIP in your phonebook will go through and cause your phone to ring. Any other number will not ring. When this mode is chosen, VIPS OK is displayed on the LCD in idle mode unless you have unread messages / missed calls (to enable, see part 11.2.1).
Anonymous	This extra feature allows you to block call that do not have a number attached to them (ie private calls, international calls, etc). This option can be enabled on top of any of the previous four (to enable, see part 11.3).

## 11.1. Manual call block mode

Manual call block is the easiest option when starting out. When you chose ON in the call block settings, all calling numbers registered in your blacklist will be blocked. You can add/remove numbers from that list at any time.

How to block an incoming call:

When the phone is ringing and before answering, press . It will terminate the call and offer you the option to register the number to the blacklist in one click.

Then to confirm the registration of this number in the blacklist, press OK.

**IMPORTANT: if you don't confirm, the number will not be added to the blacklist and the next call will go through normally.**

### 11.1.1. Enable manual mode

Menu	↑↓	Call block	↑↓	Block set.	Off
					<b>On*</b>
					VIP OK
					Contacts OK

Press **OK** , press **▲** or **▼** to select **Call block**.

Press **OK** , press **▲** or **▼** to select **Block set.**

Press **OK** , press **▲** or **▼** to select **On** (manual mode).

OR

In idle mode, press  to access **Block set.** directly.

After you enable this option, the call block icon  will be displayed on the LCD.

## 11.2. Add numbers to Blocklist

In idle mode,

1. Press  key, **Call block** and its icon is displayed, then press **▲** or **▼** to select **Blocklist**, press **OK** to show **Blocklist numbers**.
2. Press **▲** or **▼** to select numbers stored in **Blocklist**.
3. Press **OK** to select **Add**, enter number to be blocked, press **Save key** to save.

NOTE: 1 more ways to add incoming and outgoing call numbers in Block list:

1. From incoming call numbers  
Press **▼ ?** , to enter Call list, press **▲** or **▼** to select the stored numbers in **CALL LIST**.  
Press **OK** , press **▲** or **▼** to select the **Add To Block** number.  
Press **OK** to show selected number, press **OK** to save to Block list.

## 11.3. Edit numbers in Blocklist

In idle mode,

1. Repeat step 1 and 2 in Section 11.2. to select the stored numbers.
2. Press **OK**, press **▲** or **▼** to select **Edit**, start to edit selected number press **OK** to save.

## 11.4. Delete numbers in Blocklist

### 11.4.1. Delete a number from blocklist

1. Repeat step 1 and 2 in Section 11.2. to select the stored numbers.
2. Press **OK**, press **▲** or **▼** to select **DELETE**, **Confirm?** is shown, and then press **OK** to confirm.

### 11.4.2. Delete all numbers from blocklist



In idle mode,

1. Repeat step 1 and 2 in Section 1.2. to select the stored numbers.
2. Press **OK**, press **▲** or **▼** to select **Delete all** number to delete at a time, press **OK**, **Confirm?** is shown, and then press **OK** to confirm.

## 12. Automatic call block mode

### 12.1. VIPs only

In this restrictive automatic mode, only calls from numbers registered as VIP in your phonebook will go through and make your phone ring.

<b>Menu</b> 	<b>Call block</b> 	<b>Block set.</b>	<b>Off</b>
			<b>On</b>
			<b>VIP OK*</b>
			<b>Contacts OK</b>



Press **Menu**, press **▲** or **▼** to select **Call block**.

Press **OK**, press **▲** or **▼** to select **Block set**.

Press **OK**, press **▲** or **▼** to select **VIP OK** (Automatic mode).

### 12.2. Contacts only

In this broad automatic mode, only calls from contacts registered in your phonebook (normal and VIP) will go through and make your phone ring.

<b>Menu</b> 	<b>Call block</b> 	<b>Block set.</b>	<b>Off</b>
			<b>On</b>
			<b>VIP OK</b>
			<b>Contacts OK*</b>

Press **Menu**, press **▲** or **▼** to select **Call block**.

Press **OK**, press **▲** or **▼** to select **Block set**.

Press **OK**, press **▲** or **▼** to select **Contacts OK** (Automatic mode).

## 13. Anonymous call block mode

This feature allows you to block numbers that do not display a number on your phone. It can be enabled or disabled independently from the previous call block modes.

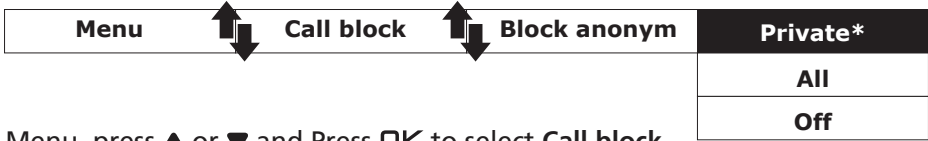

Press Menu, press ▲ or ▼ and Press **OK** to select **Call block**.



Press ▲ or ▼ to select **Block anonymous**.

Press **OK** , press ▲ or ▼ to select one of the options.

### 13.1. Block Private Calls

This mode will block incoming calls that have been purposely kept their numbers private from you.

In idle mode,

1. Press  key, Call block and its icon is displayed, press **OK** .
2. Press ▲ or ▼ to select Block anonymous.
3. Press **OK** , press ▲ or ▼ to select Private, press **OK** to confirm.
4. Press Back twice .
5.  will be displayed on the upper side of LCD.

### 13.2. Block All Anonymous Calls

This mode will block all unknown incoming calls, including private calls, international calls, pay phone and other out-of-area calls.

In idle mode,

1. Repeat step 1 and 2 in Section 13.1.
2. Press **OK** , press ▲ or ▼ to select **ALL**, press **OK** to confirm.
3.  After you enable this option, the call block icon will be displayed on the LCD.

### 13.3. Set Block Anonymous Calls OFF

In idle mode,

1. Repeat step 1 and 2 in Section 13.1.
2. Press **OK** , press ▲ or ▼ to select **Off**, press **OK** to confirm.
3.  will only disappear from the LCD if the regular call block (see 1. And 2.) is also set to OFF.

## 14. REMINDER

The reminder feature helps remind you of important events. You can set the reminder to record your voice, or use alarm sound in order to remind you only once, or in daily, Monday to Friday or Saturday to Sunday. Once you set the reminder, the system will alarm you at the alarm time. Each reminder can be up to 2 minutes in length.

### 14.1. Turn on alarm reminder, set time and frequency.

1. Press **OK** when idle.
2. Press **▲** or **▼** to select **REMINDER**, then press **OK**.
3. Press **▲** or **▼** to select **ALARM 1.. ALARM 10**, then press **OK**.
4. **ON/OFF** appears then press **OK** to select **ON**.
5. Enter the time then press **OK**.
6. Press **▲** or **▼** to select frequency **ONCE, DAILY, MON-FRI, SAT-SUN**.
7. Press **OK** to confirm. You hear confirmation tones.

### 14.2. Select melody of the alarm reminder



1. Repeat step 1 to 3 in Section 14.1.
2. **ON/OFF** appears then press **▼** to select **MELODY**, press **OK**.
3. Press **▲** or **▼** to select desired melody.
4. Press **OK** to confirm. You hear confirmation tones.

### 14.3. Rename the alarm reminder

1. Repeat step 1 to 3 in Section 14.1.
2. **ON/OFF** appears then press **▼** to select **RENAME**, press **OK**.
3. Change name from **ALARM** to the name you desire (max. 9 letters or digits)
4. Press **OK** to confirm. You hear confirmation tones.

Note: during entering number or name, you can correct a letter by pressing , then last number or letter will be removed.

## 14.4. Record Voice memo of the alarm reminder

1. Repeat step 1 to 3 in Section 14.1.
2. **ON/OFF** appears then press ▼ to select **VOICE MEMO**, press **OK**.
3. **PLAY** appears then press ▼ to select **RECORD**, press **OK** to start recording.
4. **RECORDING...** appears after beep sound, you can record your voice.
5. Press **OK** to finish your voice recording. Your voice will replay.
6. Press  to return previous menu or long press  to return to standby mode.

Notes:

1. You can playback your memo voice in step 3 to select **PLAY**, then press **OK**. **PLAYING VOICE MEMO** will appear.
2. You can delete your memo voice in step 3 to select **DELETE**, press **OK**. Then, **RESET TO DEFAULT** will appear after the memo is deleted.
3. If no voice memo in the alarm reminder, only melody will play for 2 minutes at the alarm time.



## 15. ANSWERING MACHINE

The total storage capacity for the outgoing message, messages and memos is approximately 30 minutes.

Note: Your answering system will answer call after 14 rings even when the answering machine is turned off. This is to allow the remote access feature to work.

### 15.1. Turn on/off the answering machine

If you turn the answering machine on, it answers calls and records messages.



The red message LED  on the telephone base is on and the  icon on the handset will be on too.

#### Answer on/off through Cordless handset:



1. Press **OK** in idle mode.
2. Press ▲ or ▼ to select **ANS. SYS**, then press **OK**.
3. Press ▲ or ▼ to select **TAM ON/OFF**, then press **OK**.
4. Press ▲ or ▼ to select **ON** or **OFF**, then press **OK** to save.  
You hear confirmation tones.

#### Answer on/off through base:

Press  key on the base to turn the answering machine on or off.

Note: When Answering machine is off, the red message LED  on the telephone base will be off and the  icon on the handset will be off too.

## 15.2. Message Playback

If 2 new voice messages are stored in the phone, "2 NEW MESSAGES" will appear and the  icon will flash on the handset screen, the red message LED  on the telephone base will flash.

If memory is full, **MEM FULL** will display in the screen.

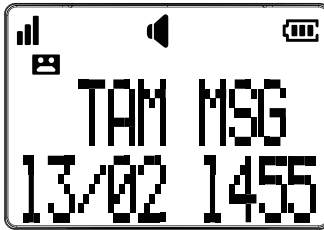

### Listen new messages through the Cordless Handset:

1. Press **OK** in idle mode.
2. Press **▲** or **▼** to select **Ans.Machine**, then press **OK**.
  - To play new messages, press **OK** to select **PLAYBACK**.
  - Time and date of the message played will display on the screen if listened through handset.



- After end of all messages, "END OF MESSAGES" will appear.

### Options during playback:

- Press  to play the messages through the handset earpiece.
- Slide  up or down on side of handset to adjust the speakerphone volume.
- Press **6** to skip to the next message.
- Press **4** to repeat the message currently playing.  
Press **4** twice to listen to the previous message.
- Press **2** to delete the current message
- Press **5** or  to stop.

OR,

During playback, press **OK** to select options:

**STOP**

**FORWARD**





**PREVIOUS**

**DELETE**

### Listen new messages through the Base:

1. Press **▶/■** to listen to new messages through base speaker.  
After playback all new messages, a long beep will emit from the base.
2. To playback old messages, press **▶/■** again to listen.

### Options during playback:

- Slide left and right  on the side of base to adjust the speaker volume
- Press  to repeat the message currently playing.
- Press  to delete the current message.
- Press  to stop.
- Press  to reduce the playback speed.

## 15.3. Delete Old Messages in the Answering Machine

### Delete all old messages through the Handset:

1. Press **OK** in idle mode.
2. Press **▲** or **▼** to select **Ans.Machine**, then press **OK**.
3. **PLAYBACK** appears and then press **▲** or **▼** to select **DELETE OLD**, then press **OK**.
4. The handset displays **CONFIRM?** Then press **OK** to confirm.
5. The handset displays **DELETING...** and then **DELETED** is shown. You hear confirmation tones.

### Delete a message through the base:

1. Press **▶/■** to listen new or old messages through base speaker.
2. Press  to delete the message being listened. You hear confirmation tones.

### Delete all old messages through the Base:

1. During idle mode, long press  to delete all old messages. You hear confirmation tones.



## 15.4. Record a Memo

You can record your memo message for another user.

1. Press **OK** in idle mode to enter the main menu.
2. Press **▲** or **▼** to select **Ans.Machine**, then press **OK**.
3. **MSG Playback** appears and then press **▲** or **▼** to select **MEMO**, then press **OK**.
4. **RECORDING** shows on the screen. After the tone, speak towards the microphone.
5. Press **OK** when you finish recording. **PLAYING ...** shows on the screen. Your recorded memo will be playback. then returns to the previous menu.
6. When another user listens the memo (procedure refers to Section 15.2 through handset or base), the time & date of the memo will display on the screen if listened through handset.



### Notes:

- MEM FULL will display in the screen if you attempt to record a memo when the memory is full.
- Each memo can be up to 4 minutes in length.
- Memos shorter than two second are not recorded.

## 15.5. Outgoing Message (OGM)

The telephone is preset with a greeting that answers calls with “please leave a message after the tone.” You can use this default outgoing message, or replace it with your own.

### 15.5.1. Play your outgoing message (OGM)

1. Press **OK** in idle mode.
2. Press **▲** or **▼** to select **ANS. SYS**, then press **OK**.
3. **PLAYBACK** appears and then press **▲** or **▼** to select **SET TAM**, then press **OK**.
4. **CALLSCREEN** appears and then press **▲** or **▼** to select **TAM MSG**, then press **OK**.
5. **PLAY** appears then press **OK**, **PLAYING ANNC...** appears then it will play the default outgoing message.

## 15.5.2. Record your own outgoing message (OGM)

1. Repeat step 1 to 4 in Section 15.5.1.
2. **PLAY** appears on the screen, then press ▼ to select **RECORD**, and then press **OK** .
3. **RECORDING...** appears and then you can record your outgoing message after beep tone.
4. After finishing record, press **OK** , **PLAYING ANNC...** appears then it will playback your own outgoing message.

### Notes:

- Your outgoing message can be up to 90 seconds in length.
- Outgoing messages shorter than two seconds are not recorded.

## 15.5.3. Delete your outgoing message

1. Repeat step 1 to 4 in Section 15.5.1.
2. **PLAY** appears on the screen, then press ▼ to select **DELETE**, and then press **OK** .
3. **RESET TO DEFAULT** will show, You hear confirmation tones.

## 15.6. Answering Machine Settings

### 15.6.1. Set Answer Delay

You can set the number of rings before the answering machine answers and starts playing your OGM. You can set the answering machine to answer after 2 to 10 rings or TOLL SAVE.

With TOLL SAVE selected, the answering machine answers after 2 rings when you have new messages, and after 4 rings when you have no new messages.



1. Press **OK** in idle mode.
2. Press ▲ or ▼ to select **ANS. SYS**, then press **OK**.
3. Press ▲ or ▼ to select **SET TAM**, then press **OK**.
4. Press ▲ or ▼ to select **ANS. DELAY**, then press **OK**.
5. Press ▲ or ▼ to select **2, 4, 6, 8, 10 rings**, then press **OK** to save. You hear confirmation tones.

### 15.6.2. Recording Time

You can set the maximum length of the recording time of the incoming messages.



1. Repeat step 1 to 3 in Section 15.6.1.
2. Press ▲ or ▼ to select **REC. TIME**, then press **OK** .
3. Press ▲ or ▼ to select **60s, 120s, 180s**, then press **OK** to save. You hear confirmation tones.

### 15.6.3. Call Screening



When the answering machine is set to ON and when there is an incoming message, the base will start call screening if call screening is set to ON after the preset numbers of rings of answer delay, press **OK** to screen the call on your handset too. At any time if you want to pick up the call, you can press  on the handset, or press  on the telephone base, or pick up combo handset and the message recording will be stopped automatically. If the answering machine is in the process of recording, the message already stored will be saved.

1. Repeat step 1 to 3 in Section 15.6.1.
2. **CALLSCREEN** will display, then press **OK**.
3. Press **▲** or **▼** to select between **On** and **Off**, then press **OK** to save. You hear confirmation tones.

#### Options while a message is being recorded in the telephone base:

- Slide up/down  on the side of base to adjust the speaker volume.
- Press  to temporarily turn off the feature.

#### Options while a message is being recorded in the cordless handset:

- Press **OK** to temporarily turn on the feature if it is set to off.
- Slide  up or down on side of handset to adjust the speakerphone volume.
- Press  to temporarily turn off the feature.

### 15.6.4. Activate Remote Access

You can access the answering machine remotely by dialling your fixed telephone number from any touch-tone telephone.

Your phone lets you check your messages, or otherwise operate your answering machine, by calling the answering machine when you are away from home by entering a 4-digit remote access PIN on a tone-dialing phone.

#### To activate remote access function:

1. Press **OK** in idle mode.
2. Press **▲** or **▼** to select **ANS. SYS**, then press **OK**.
3. Press **▲** or **▼** to select **SET TAM**, then press **OK**.
4. Press **▲** or **▼** to select **REMOTE ACC**, then press **OK**.
5. Press **▲** or **▼** to select **ON** or **OFF**, then press **OK** to save. You hear confirmation tones.

#### To change the remote code:

1. Repeat step 1 to 3 as above.
2. Press **▲** or **▼** to select **CHANGE PIN**, then press **OK** to enter a 4-digit number.
3. Press **OK** to save. You hear confirmation tones.

### To remotely access your answering machine remotely:

You can ring your phone from another tone-dialing phone to switch on or off the answering machine and listen to your messages remotely.

1. Place a call from a tone-dialing phone to your phone.
2. When the answering machine answers the calls and starts playing the outgoing message, enter \* key and then 4-digit remote access code (0000 is the preset code).
3. Then the following description will operate by pressing the following key in your tone-dialing phone.

Key	Description
2	Delete the message currently being played.
4	Repeat the current message or press twice for the previous message.
5	Play all messages.
6	Skip to the next message.
7	Turn on the answering machine.
9	Turn off the answering machine.

#### **Notes:**

- After 5 seconds of key inactivity, the answering machine automatically cuts off communication.
- When the answering machine is turned off, the telephone answers after 14 rings, and plays the outgoing message.

### **15.6.5. Message Alert Tone**

When the message alert tone is set to **On**, the telephone base beeps every 10 seconds to alert you to new messages.

The tone stops when all new messages have been reviewed.

1. Press **OK** in idle mode.
2. Press **▲** or **▼** to select **ANS. SYS**, then press **OK**.
3. Press **▲** or **▼** to select **SET TAM**, then press **OK**.
4. Press **▲** or **▼** to select **MSG ALERT**, then press **OK**.
5. Press **▲** or **▼** to select **ON** or **OFF**, then press **OK** to confirm.  
You hear confirmation tones.

Pressing any telephone base key temporarily silences the message alert tone. The message alert tone plays with the next incoming message.

## 16. TECHNICAL SPECIFICATIONS

Free Field Range	Up to 300 metres*
Indoor Range	Up to 50 metres*
Handset Battery Life (average values)	10 hours talk time** 100 hours standby**
Number of Handsets	Up to 4
Intercom Mode	Yes
Three-Way Conference	Yes (1 outside correspondent + 2 internal correspondents)
Electrical Connection/Base Mains Adaptor/Charger	<p>Base: Model No.: R201100135</p> <p>Input: 100-240 V/50-60 Hz Output: 6 V DC/400 mA, 2.7 W Charger: R201100135</p> <p>Input: 100-240 V/50-60 Hz Output: 6 V DC/450 mA, 2.7 W</p> <p>Only use the adaptors supplied with telephone. Single-phase AC, excluding IT install defined by the EN62368-1 standard.</p> <p>Caution: The network voltage is classified as hazard by the criteria of this standard.</p>
Telephone Connection	Appliance designed for connection to a TNV3 class (telecommunications network voltage) analogue telephone line as defined by the EN62368-1 standard.
Batteries	AAA NiMH batteries– 1.2 V (3 pieces) Only use the batteries supplied with the telephone. Use any other type of battery presents a risk of explosion. Used batteries must be disposed of in compliance with current environmental protection regulations.
Operating Temperature	From 5°C to 40°C

\* Values may vary according to environment.

\*\* Depending on initial battery charge.

# 17. TROUBLESHOOTING

If you have difficulty with your phone, please try the suggestions listed below.

As a general rule, if a problem occurs, remove the batteries from all the handsets in your installation for about 1 minute, then disconnect and reconnect the power supply to the base and reinstall the handset batteries.

## **Phone does not work**

- Make sure you installed the batteries correctly.
- Check that the mains power is correctly connected for the base and charger

## **“NO LINE” appears in the screen**

- Is the telephone cord plugged into the phone socket?
- Only use the telephone cord supplied with the phone.
- The telephone line cord might be malfunctioning. Install a new telephone line cord.
- Disconnect the telephone and connect a different telephone. If there is no dial tone on this telephone, the problem is in your wiring or local service. Contact your local telephone company.

## **No dial tone**

- Is the telephone cord plugged into the phone socket?
- Check that the mains power is switched on.
- Only use the telephone cord supplied with the phone.
- The telephone line cord might be malfunctioning. Install a new telephone line cord.
- Move the cordless handset closer to the telephone base. It might be out of range.
- Disconnect the telephone and connect a different telephone. If there is no dial tone on this telephone, the problem is in your wiring or local service. Contact your local telephone company.

## **Cannot dial out or receive calls**

- Check that the mains power is correctly connected.
- The battery may need recharging.
- Has there been a power cut? If so, place the handset back on the base for 10 seconds and try again. If it still does not work disconnect the batteries and mains power for 10 minutes, then reconnect and try again.
- If you are connected to a PABX, check whether you need to dial an access code.

## **Your own voice cannot be announced when the telephone number of incoming call is same as 1 of 4 photo memories stored**

- The ringer volume may be switched off.
- Voice recording in 1 of 4 photo memories was not done successfully. Please refer to Section 6.3.2. to record again.
- Your telephone line may not be subscribed or availability of the service from the fixed line operator.

## **Cordless handset does not ring (Caller Line Identification)**

- The ringer volume may be switched off.
- Check that the mains power is correctly connected.
- Make sure the cordless handset is registered to the base.

## **No display in cordless handset**

- The batteries may be flat, dead or incorrectly inserted.
- Recharge or replace the batteries

## **Handset displays "PUT ON BS TO POWER"**

- Check that the mains power is correctly connected.
- Check that the cordless handset is within range of the base.

## **No voice tag announcement from cordless handset during ringing**

- It should become normal after 1 minute in idle mode without any operation of the phone.

## **You hear the busy tone when you press key on handset**

- Make sure the cordless handset is in range of the base.
- Another cordless handset registered to your telephone base may be on the line.

## **Buzzing noise on my phone or on other electrical equipment nearby**

- Sometimes your phone can interfere with other electrical equipment if it is placed too close. It is recommended that you place your phone at least one metre away from electrical appliances or metal obstructions to avoid any risk of interference.
- If you have an ADSL internet service ensure correct filters are installed to prevent interference.

## **Answering machine does not record any messages**

- Make sure the answering machine is switched on.
- The memory may be full, please delete some old messages to free up space.

## **Cannot access your messages from another phone**

- Have you changed the remote access security PIN code?
- Make sure you are calling from a touch-tone telephone. When dialling a number, there should be tones.

- The answering machine might not detect the remote access code when your outgoing message is playing. Try again to press remote access code quickly.
- There might be interference on the telephone line you are using. Press the dial pad keys firmly when dialing.

**Voicemail and  show on the display and I don't know why.**

Your telephone has voicemail indication that is separate from the built-in answering system. If  appears on the display, then your telephone has received a signal from your telephone service provider that you have a voicemail message waiting for you to retrieve from your telephone service provider. Contact your telephone service provider for more information on how to access your voicemail.

The store where you bought your telephone can also provide you with information and after-sales support.

## **18. GUARANTEE**

Please read carefully the user guide included in this box. Xtra 2355 is an approved equipment in accordance with the European regulations, attested by the CE marking. The product you just bought is a technological product, it must be handled with care.

Note: You have a legal warranty on this product in accordance with the regulations applicable to the sale of consumer goods in the country in which you made this purchase.

For any information regarding this legal warranty, please contact your dealer. Without prejudice to the legal guarantee of the products, ATLINKS guarantees that the product in this box conforms to its technical specifications contained in the user guide included in the this box, and this during a warranty period, counted from the date of purchase of the new product, the date on your invoice or ticket checkout where is indicated the name of your reseller, and equal to: Twenty four (24) months for the telephone, excluding consumables, accessories and batteries. For any claim under this warranty during the warranty period, you must return the entire Product to your dealer, together with the proof of purchase, the invoice or receipt issued by your dealer, indicating the place of purchase and the serial number of the Product, following the appearance or discovery of the defect. ATLINKS undertakes to repair any defective item due to a defect in design, material or workmanship, at its expense, or to replace, at its expense, by an identical or at least equivalent element in terms of functionalities and performance. If the repair or replacement is impossible under normal commercial conditions, the Product will be refunded or replaced by a Product equivalent. Within the maximum limit allowed by the applicable law, the product or element replacement, which may be new or reconditioned, is warranted during a period of ninety (90) days from the date of repair or until the end date of the initial warranty period, whichever is the earlier greater than ninety (90) days, it being specified that any



period of immobilization of the Product of at least seven (7) days will be added to the warranty period remaining to run. This warranty does not apply in the following cases:

- Installation or use not in accordance with the instructions in the guide of the user,
- Incorrect connection or abnormal use of the Product, especially with noncompatible accessories, as indicated in the user guide,
- Product opened, modified or replaced by means of non-approved parts, serial number deleted, illegible, damaged,
- Normal wear, including normal wear and tear on accessories, batteries and displays,
- Failure to comply with the technical and safety standards in force in the area geographical use,
- Product having suffered a shock or a fall,
- Product damaged by lightning, electrical surge, heat source or radiation, water damage, exposure to conditions of temperature, humidity or other excessive ambient conditions or any other cause external to the product,
- Negligence or faulty maintenance,
- An intervention, a modification or a repair carried out by a not authorized by ATLINKS.

If the returned Product is not covered by the warranty, you will receive a quote from repair that will mention the cost of analysis and transportation costs that you will be charged if you want the Product returned to you. This guarantee is valid in the country in which you regularly purchased the Product, provided that the country is a member of the European Union. Subject to the legal provisions in force, all warranties other than described herein are expressly excluded.

TO THE MAXIMUM EXTENT PERMITTED BY APPLICABLE LAW,

A) THIS WARRANTY IS EXCLUSIVE TO ALL OTHER WARRANTIES EXPRESS OR IMPLIED, INCLUDING, BUT NOT LIMITED TO, WARRANTIES OF

MERCHANTABILITY OR FITNESS FOR A PARTICULAR PURPOSE PARTICULAR;

B) ATLINKS DISCLAIMS LIABILITY FOR LOSS OR DETERIORATION OF DATA, LOSS OF USE LOST TO WIN, LOSS OF CHANCE, DEREVENUES OR INCOME, LOSS OF OPERATION, DAMAGES INDIRECT, CONSEQUENTIAL, CONSEQUENTIAL OR INCIDENTAL;

(C) ATLINKS LIABILITY IS LIMITED TO THE VALUE OF PURCHASE OF PRODUCT EXCEPT HEAVIL OR UNINTENTIONAL FAULT AND EXCEPT DAMAGE BODY

## 19. SAFETY

In the event of an electrical hazard, the mains adapter acts as 230V power isolating device. It should therefore, as a precaution, be installed close to the appliance and be easily accessible. To disconnect the device from the primary power source, the mains adapter must be removed from the 230V AC/50 Hz socket.

If the mains adapter fails, it must be replaced by an identical model.

We recommend that you also keep a conventional telephone – one that doesn't require a power supply – as a backup.

***! Do not use your telephone to notify a gas leak when standing in the vicinity of the leak.***

It is recommended that you avoid using this device during electrical storms.

Do not attempt to open the batteries, as they contain chemical substances. In the event of leakage, avoid contact with the skin, eyes, nose and mouth. In the event of contact, rinse the affected part for about twenty minutes with running water and seek urgent medical attention. Clean the product with absorbent paper or a dry cloth and contact your reseller for replacement batteries.

Hereby, ATLINKS EUROPE declares that the radio equipment type DECT is in compliance with Directive 2014/53/EU. The full text of the EU declaration of conformity is available at the following internet address: [www.swissvoice.net](http://www.swissvoice.net)

Average power per channel: 10mW

Maximum Output Power (NTP) : 24dBm

Frequency Range : 1880-1900MHz

**Swissvoice Xtra 2355**



## 20. ENVIRONMENT



This symbol means that your inoperative electronic appliance must be collected separately and not mixed with the household waste. The European Union has implemented a specific collection and recycling system for which producers are responsible.

This appliance has been designed and manufactured with high quality materials and components that can be recycled and reused. Electrical and electronic appliances are liable to contain parts that are necessary in order for the system to work properly but which can become a health and environmental hazard if they are not handled or disposed of in the proper way. Consequently, please do not throw out your inoperative appliance with the household waste.

If you are the owner of the appliance, you must deposit it at the appropriate local collection point or leave it with the vendor when buying a new appliance.

- If you are a professional user, please follow your supplier's instructions.
- If the appliance is rented to you or left in your care, please contact your service provider.

Keen to preserve the environment, ATLINKS has equipped this appliance with a switching power supply, offering better energy efficiency. The advantages include not only very low electricity consumption, but also a more compact format than the conventional power supply units used by the previous range.

The used batteries from your telephone must be disposed of in compliance with current environmental protection regulations. Comply with your local regulations.

Return your batteries to your reseller or dispose of them at an approved recycling centre.

***Help us protect the environment in which we live!***





## **ATLINKS**

147 avenue Paul Doumer  
92500 RUEIL-MALMAISON France  
RCS Nanterre 508 823 747

[www.swissvoice.net](http://www.swissvoice.net)

Swissvoice is a trademark of Swissvoice International SA.

©Copyright Swissvoice International SA 2021

The Manufacturer reserves the right to modify the specifications of its products in order to make technical improvements or comply with new regulations.

Swissvoice Xtra 2355  
A/W No.: 10002498 Rev.0 (EN)  
Printed in China