

Doro Watch

English



Contents

How to set up your Doro Watch	1
Unbox your new watch	1
Getting started	2
Activate the watch	2
Charge your watch	3
Install Doro Companion	5
Initial setup of the app.....	6
Using the watch	7
Watch overview	7
Wear on your wrist	8
Turn the watch on /off.....	9
Navigate your watch	9
Watch menu	11
The phone app, Doro Companion.....	14
App menu	14
Health tab.....	15
Exercise tab	16
Watch tab.....	17
Me tab	19
Assistance button.....	20
Other	20
Care and maintenance	20
Correct disposal of this product	21
Correct disposal of batteries in this product	21
EU Declaration of Conformity.....	21
UK Declaration of Conformity.....	21
Ecodesign declaration, energy efficiency for external power supply .	22
Specifications	22

How to set up your Doro Watch



CAUTION

Doro Watch is not a medical device and does not replace a doctor. If you do not feel well, consult a doctor.

IMPORTANT!

To turn on the watch for first use, it must be placed in the charging cradle.

Note! All illustrations are for illustrative purposes only and may not accurately depict the actual device.

This guide is for reference only. The actual device, including but not limited to the colour, size, and screen layout, may vary. The actual device and the items supplied may vary depending on the software and accessories available in your region or offered by your service provider. Your local Doro dealer provides additional accessories. The supplied accessories provide the best performance with your watch.

When you first get your watch, there is a few actions that you need to take before starting to use it.

Unbox your new watch

The first step is to unbox the watch and assess the items and equipment included in the delivery. Make sure to read through the manual so you can familiarise yourself with the equipment and the basic functions. For more information about accessories or other Doro products please visit www.doro.com or contact our Helpline.

- The items supplied with the device and any available accessories may vary depending on the region or service provider.
- The supplied items are designed for this device and may not be compatible with other devices.
- Appearances and specifications are subject to change without prior notice.
- You can purchase additional accessories from your local Doro retailer. Make sure they are compatible with the device before purchase.
- Only use chargers and accessories that have been approved for use with this particular model. Connecting other accessories may be dangerous and may invalidate the watch's type approval and warranty.



Getting started

Note! Before you start to use your new watch, remove the protection film that covers the device screen.

Requirements to use the watch

- An **Android Smartphone** or an **Apple iPhone** to use the **Doro Companion** app that connects with the Doro Watch and collects your exercise data.
The phone should be compatible with:
 - Android version 6.0 or later
OR iOS version 9 or later
 - Bluetooth version 4.0 or later
 - Optional for **Response by Doro** assistance button function: Doro Smartphone (Android 10.0 or later)
- A **Google account** or an **Apple-ID** to be able to download and install the **Doro Companion** app

Activate the watch

IMPORTANT!

To turn on the watch for first use, it must be placed in the magnetic charging cradle.

Note! The watch needs to be paired with a smartphone that have the Doro Companion app installed. See *Install Doro Companion*, p.5.

Do the steps in the following order for a successful setup.

1. *Charge your watch*, p.3.
Once you've charged your watch, it will automatically turn on. Wait for the watch to start.
2. *Install Doro Companion*, p.5.
3. *Initial setup of the app*, p.6.

When the setup of the watch is finalised you can continue with *Using the watch*, p.7.

Charge your watch

IMPORTANT!

To turn on the watch for first use, it must be placed in the magnetic charging cradle.

⚠ CAUTION

Only use chargers and accessories that have been approved for use with this particular model. Connecting other accessories may be dangerous and may invalidate the watch's type approval and warranty.

We recommend that you fully charge it before first use.

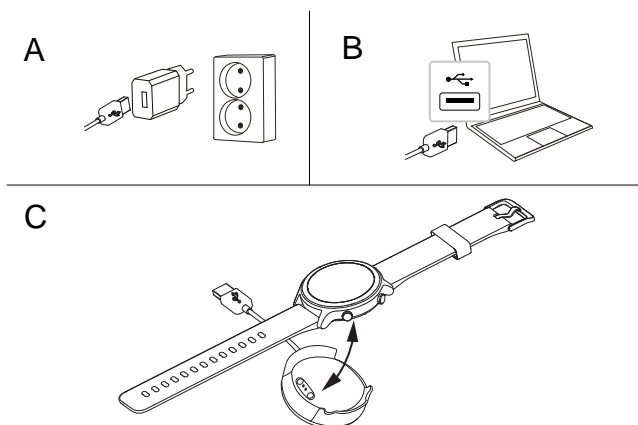

- A. Insert the USB charging connector into the provided charger, then plug it into a wall socket.
- B. Alternatively, you can plug the included USB charging connector into a USB port on your computer, or any certified USB port that permits charging, 5V/500mA or above, maximum 5V/2A. Generally charging is quicker if plugged into the wall socket charger.
- C. Place the watch in the magnetic charging cradle.

Note! The watch will warn when the battery charging level is getting low. Charge the watch when possible.

Make sure the charging connectors, on both watch and charging cradle, are clean to assure good connection.

Save energy

When you have fully charged the battery and have removed the watch from the charging cradle, we recommend that you unplug the charger from the wall socket.

Note! To save power, the screen is turned off after a while. Press the upper **Menu button** or simply lift your arm to activate the screen.

If the battery is completely discharged, the device cannot be turned on immediately when the charger is connected. Allow a depleted battery to charge for a few minutes before turning on the device.

Install Doro Companion

Doro Companion is the app that links the watch with your smartphone. Download and install the Doro Companion app from Google Play store or Apple App Store on your smartphone. Use the provided QR code or simply search for “Doro Companion” in respective application store. To scan the QR code, please use a QR code scanner app like **Doro QR scanner**, Google Lens or a camera application that supports QR code scanning.



or click play.google.com/store/apps/details?id=com.companion.wear



or click apps.apple.com/app/id1627230971

Start the Doro Companion app when the installation is finalised.

Approve the user agreement and privacy policy as well as the other permissions required to operate the application. It's especially important that you allow the Doro Companion app to handle notifications to/from your phone. This to allow you to also see the phone notifications on your watch.

Back to *Activate the watch*, p.2

Initial setup of the app

Note! Bluetooth must be activated on your Smartphone.

1. Start the app, view and click through the informative start-up guide and allow the needed permissions and agreements.
2. Doro Companion will automatically start and search for the watch to be able to connect with it.
3. Make sure the display of your watch is lit. If not, see *Charge your watch*, p.3.
4. Tap the found watch to pair with the phone.
Alternatively if no watch is found, tap **Scan QR code** to scan the QR code on the watch.
5. On the watch, tap  to confirm the connection.
6. Tap **Complete** to complete the watch-phone connection.
Your watch is now setup, but please continue to finalise the app installation set-up.
7. Select the country the watch will be used in.

Note! Country names might only be listed in English and cannot be changed later.

8. Enter a **Nickname** for your profile.
9. Enter your personal information.
10. Allow some permissions needed for optimal performance.
11. Tap **Turn on** to send phone notifications to the watch.
Select **Doro Companion** → enable **Allow notification** and then go back to the Doro Companion app.
12. A summary of your activity goals, notification settings, call alert and preferences is now displayed. Tap each field to set/change any setting and when done, press **Let's go!** to finalise the initial setup.

Back to *Activate the watch*, p.2

Using the watch

Watch overview

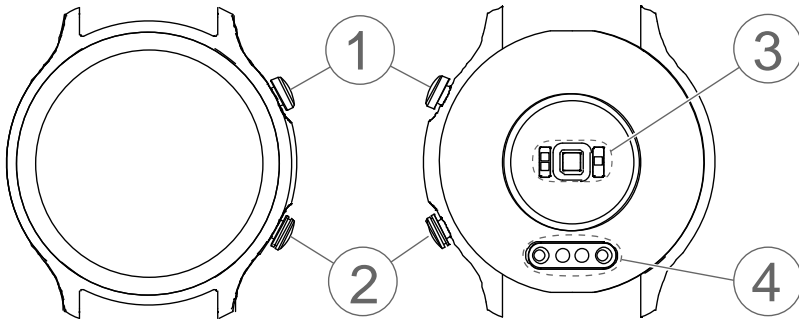

1. Menu button

- Press to wake the screen.
- Press to access/exit the menu.
- Press and hold to power on/off.

IMPORTANT!

To turn on the watch for first use, it must be placed in the magnetic charging cradle.

2. Special function button

- Press and hold to activate the emergency assistance function on Response by Doro on supported Doro Smartphones. See *Assistance button*, p.20.
- Press and hold to activate “Find my phone” on all other Smartphones.

3. Heart rate/oxygen saturation sensor

Note! The green light will flash occasionally, this is normal and it's to measure heart rate, blood oxygen saturation and sleep data.

4. Magnetic charging connector

Wear on your wrist

Wearing the watch with the right fit, keeps you comfortable and lets the sensors, such as the heart rate and blood oxygen saturation sensor do their job. Make sure your band is not too tight. Also, sensors will only work if you wear your watch on the top of your wrist.

Place the watch on your wrist, with the display facing outwards. Adjust the strap to fit snugly for correct heart rate and blood oxygen saturation measurements, but loose enough that it can move back and forth. The strap should be placed approximately one finger above the wrist bone.

During exercise, try moving the band higher on your wrist (2-3 finger widths above your wrist bone) to get a better fit so it's secure, but not too tight. The sensors work best with skin contact. Lower the band on your wrist and loosen it after exercise.



See also these recommendations for better comfort when wearing your watch:



- Loosen the band if it causes discomfort or irritation and take the watch off for a break if it persists.
- Remove the watch for an hour or so after extended wear. A great time to do this is while you are showering, even if it is ok to shower with the water resistant watch. Exposure to soaps, shampoos, and conditioners might cause long-term wear, skin sensitivities and you may be more likely to experience skin irritation from a wearable device.
- Remove the watch if you experience any skin irritation or other discomfort on your wrist or in your hand, such as redness, soreness, tingling, numbness, burning, or stiffness. If any of those symptoms persist, please contact our customer support and consider contacting a dermatologist.

Turn the watch on /off

To turn on the watch

- Press and hold the **Menu button**. Keep it pressed until the watch vibrates and the display lights up.

To turn off the watch

- Press and hold the **Menu button** until the watch vibrates and **Power off?** is displayed.
- In the menu, tap  to turn off the watch or  to cancel.

Navigate your watch



Press the **Menu button** to activate the screen.

You can with a finger swipe the screen up , down , left  and right .



From the watch home screen you can swipe:

Up  to display the status of the watch, including connection status with the smartphone and battery level.





Down  to see the notifications received from the phone. Swipe up  to see the list of the notifications. Tap a notification to clear the notification and then tap the **X**. At the end of the list of notifications **Clear all notifications?** is displayed. Press  to clear all notifications.



Left  or right  to view the shortcuts of your daily activity screens, like **heart rate bpm** (beats per minute) and **steps**. In the Doro Companion app, **Distance** and **Calories** can also be added to you shortcuts.



Your watch home screen displays the selected watch face.
Press and hold to select a different watch face by swiping left  or right .

Tap the screen to select the wanted watch face.
Load more watch faces in the Doro Companion app.



Press the **Special function button** (lower button) to:

- Initiate an emergency assistance alarm, if you have a compatible Doro smartphone that supports **Response by Doro**. See *Assistance button*, p.20.
- Initiate **Find My** to find your smartphone. Works on all smartphones not supporting Response by Doro.

Watch menu

If not lit, press the **Menu button** to activate the screen.



Exercise



While the watch face is displayed, press the **Menu button** to access the menu.

Tap the display for **Exercise** mode
Swipe up ▲ or down ▼ for other menu options.



Note! It's recommended to start an exercise from the app instead to enable location tracking, see *Exercise tab*, p.16.

Swipe up ▲ or down ▼ to select exercise.

Walking



Tap the display to start a **Walking** exercise. The exercise will automatically start after 3 seconds.

- Swipe up ▲ or down ▼ for other exercise data.
- Press the **Menu button** to pause the exercise registration.
- Press the **Menu button** again or tap  to resume.
- Tap  to stop the exercise.
- Tap  to finish the exercise.

Running



Tap the display to start a **Running** exercise. The exercise will automatically start after 3 seconds.
Swipe up ▲ or down ▼ for other exercise data.

Cycling



Tap the display to start a **Cycling** exercise. The exercise will automatically start after 3 seconds.

Fitness



Tap the display to start a **Fitness** exercise. The exercise will automatically start after 3 seconds.

Activity

Tap to view your daily health data, **Activity**. Swipe right ► to view:

- **Steps** walked during the day.
- **Distance** covered during the day.
- **Calories** burned during the day.

Heart rate

Tap to measure you current **Heart rate**.

Swipe right ► to view your highest and lowest heart rate during the day.

Note! The watch supports continuous heart rate measurement as well as checking of heart rate data throughout the day. You can turn this feature on or off in the app settings.

Sleep

Tap to view your sleep data, **Sleep**. The data can show the quality of your sleep.

Note! The watch can only record your sleep data if worn when you sleep.

Blood oxygen

Tap to measure you current blood oxygen saturation level, **Blood oxygen**.

Blood oxygen is a measure of the amount of oxygen in the protein (hemoglobin) in your red blood cells. To function properly, your body needs a certain level (above 90%) of oxygen circulating in the blood.

Find My



Tap to find your phone, **Find My**.



Tap  to start ring/vibration on your phone. Tap **X** to stop.

Settings



Tap to set your watch **Settings**.

Tap to adjust the following:

- **Backlight** to set how many seconds the display should be lit.
- **Brightness** to set the brightness of the display. Level 2 is for normal conditions.
- **Watch face** to select watch face. Select a watch face by swiping left  or right . Tap the screen to select the displayed watch face.
- **Reset watch** to reset the watch to factory settings. This can be used if you want to connect with another phone. All user data in the watch will be deleted. Tap  to confirm reset. The watch needs to be paired again with the Doro Companion app. The watch can also be deleted from the Doro Companion app.
- **Power off watch** to power off the watch. This action can be useful, to save energy, if you don't intend to use the watch on a daily basis.
- **About** to see the watch software version and MAC-address.

The phone app, Doro Companion

App menu

Your **Doro Companion** app is now setup and ready for use. The app is divided by 4 tabs.

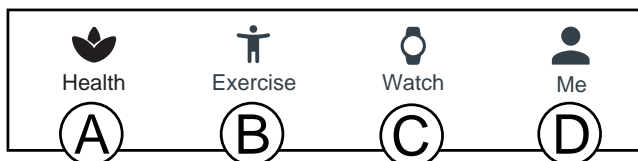

- A. **Health** displays your daily activity, health data, activity exercises and completed activity goals.
- B. **Exercise** to select and start an activity exercise.
- C. **Watch** to manage your clock settings and health tracking reminders.
- D. **Me** displays your personal information and help information.

Health tab

- A. **Refresh** button to update the data to/from the watch.
 - B. Tap to add more watches.
 - C. Daily activity data. Tap to see more detailed data in other time frames.
 - D. Daily step data. Tap to see more detailed data in other time frames.
 - E. **Sleep**: recorded sleep data. The data can show the quality of your sleep.
- Note!** The watch can only record your sleep data if worn when you sleep.
- F. **HR**: recorded heart rate data. The data can show your heart rate changes, depending on activity. Tap to see more detailed data.
 - G. **Blood Oxygen**: recorded blood oxygen saturation level data. Tap to see more detailed data.
 - H. **Workouts**: recorded activity exercises. Tap to see more detailed data.
 - I. **Medals**, see your medals when you hit the set goals. See **Me** → **Settings** → **My Goals** on *Me tab*, p.19.
 - J. **Edit Card** to add, remove or change order of the visible health cards.

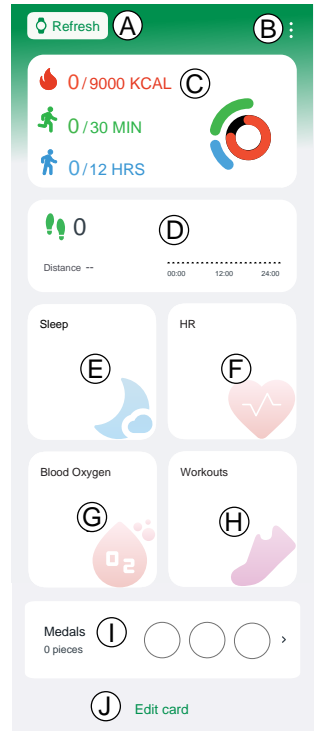

Exercise tab

Note! We recommend that you start an exercise from the app instead of the watch to allow location tracking.

The phone must be worn throughout the exercise to allow continuous location tracking.

A. Select the type of exercise:

- **Walking**
- **Running**
- **Cycling**



B. Check that the GPS signal (location) is received if it's an outdoor exercise and you want to review your movement afterwards.

C. Adjust the settings for the exercise:

Note! This is not needed to set for every exercise, as it is remembered for your next training.

- **Training Goal** to set any specific training goal.
- **Sound notification** to be notified when a distance interval is achieved.
- **Heart Rate Zone** to set you heart rate zone, that also can give an alert if/when your heart rate is too high.

D. Tap **Start** to initiate your exercise. Exercise data will be displayed in both app and watch.

-  to pause the exercise.
-  to resume the exercise.
-  to stop the exercise.
- **End** to finish the exercise.

Exercise data can be reviewed in **Workouts**, see *Health tab*, p.15.

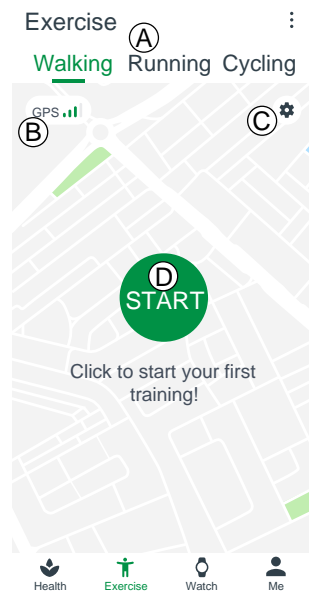

Watch tab

- A. Select the displayed watch. This is only possible if you have more than one watch connected.
- B. Tap the watch to:
- **Device upgrade** to check if there is a watch upgrade available. If an upgrade is available you will be notified and we always recommend you to perform the upgrade.
 - **About** to see the watch detailed information.
 - **Restart the device** to restart the watch if it should stop to function. Conform with **OK**
 - **Delete device**: All information on the device will be deleted, and the device will be unpaired from the phone and reset to factory default settings. Confirm with **OK**.
- C. See the available watch faces. Tap the chosen watch face to install. Tap **More** to see more available watch faces online.
- D. **Notifications and reminders** to set what notifications should be allowed on the watch. Tap **Set** and select Doro Companion to make sure that notifications to the watch are allowed.
- E. **Call Alert** to allow incoming calls notification on the watch. Tap **3-second delay** to delay the call notification.
- F. **Alarm Clock** to view and set alarm on both phone and watch. Tap **+** / **Add Alarm** to add an alarm. Up to 10 alarms can be added. Set the time for the alarm and if it should be repeated. You can also set a name for an alarm.

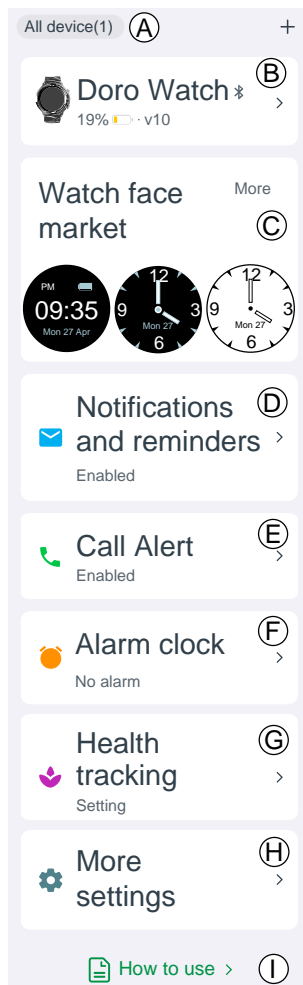

G. Health tracking to set:

- **HR** to set if your heart rate should be measured continuously when wearing the watch and how often it should be measured. Your heart rate will be measured in real time during an exercise, regardless of this setting.
- Tap **Motion** to set Walk-around Reminder. During the reminder period you set, you will be reminded to get up and walk the 50th minute each hour if you have not reached your target steps per hour.

H. More settings to set:

- **Do Not Disturb mode** when enabled, the watch will not alert with notifications and the screen will not be activated when you lift your wrist. **Do Not Disturb mode** must be enabled with a set time period.
- **Lift your wrist to turn on the screen** when enabled, the watch will automatically turn on the screen when you lift your hand.
- **Screen brightness** to set the watch screen brightness.
- **Shortcuts** to add, remove or change order of the health cards, when swiping left ◀ or right ▶ on the watch home screen.
- **Device Language** to set the watch language. Normally the watch will follow the set system language on the phone.

I. How to use to get some additional help with your watch and the Doro Companion app.

Me tab

In the Me tab you can set your personal information. This is an important basis for measuring heart rate, calorie consumption, stride length, pace and other data.

- A. The nickname you choose during setup is displayed.
Tap **Edit** to change any personal information.
- B. **My Data** to view your collective activity, health and exercise data.
- C. **Health Report** to view your weekly health report.
- D. **Settings** to set:
- **My Goals** to set your goals for steps and weight.
 - **Preferences** to set your preferences for units, start of week and time format.
 - **Clear Cache** to clear temporarily stored data to free-up memory on the phone.
- E. **Help** to get some additional help with your watch and the Doro Companion app.
- F. **Questions and Suggestions** to send a questions to Doro or leave suggestions for improvements.
- G. **Guide on Protecting Background Processes** to get help with some settings for Android to make sure that you can get the full functionality of the watch.
- H. **Check for Updates** to check if there is a newer version of the app available. If an upgrade is available you will be notified and we always recommend you to perform the upgrade.

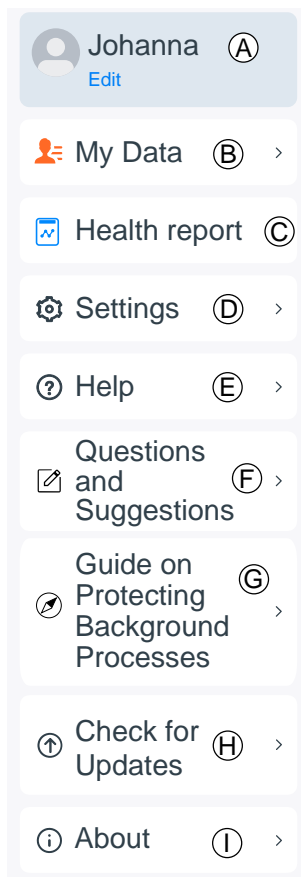

- I. **About** to see app version and approved agreements. You also have possibility to withdraw the agreement consent, which means that the app will stop to work.

Assistance button

The Doro Watch can also be paired with a Doro smartphone (Android 10.0 and later) to provide more peace of mind for both the user and their relatives. When paired, the lower button functions just like the smartphone's assistance key, activating the Response by Doro app, to alert trusted contacts that help is needed.

Press and hold the lower button for 3 seconds to initiate an alarm.

Note! Response by Doro needs be setup on a compatible Doro smartphone (Android 10.0 and later) for this to work.

Phone and watch must also be within range of the wireless Bluetooth communication between the devices. This is normally 5-10 meters in the same room.

Other

Care and maintenance

Your unit is a technically advanced product and should be treated with the greatest care. Negligence may void the warranty.

- **Waterproof performance:** the device is not suitable for diving, swimming in the sea or sauna; it is suitable for swimming pool, shower (cold water) and swimming in shallows.
- Do not use or keep the unit in dusty, dirty environments.
- Do not keep the unit in warm or cold places.
- Do not drop the unit. Do not knock or shake it either. If it is treated roughly the circuits and precision mechanics can be broken.
- Do not use strong chemicals to clean the unit.

The advice above applies to the unit, battery and other accessories. If the unit is not working as it should, please contact the place of purchase for service. Don't forget the receipt or a copy of the invoice.

Correct disposal of this product



(Waste Electrical & Electronic Equipment)
(Applicable in countries with separate collection systems)

This marking on the product, accessories or manual indicates that the product and its electronic accessories (e.g. charger, headset, USB cable) should not be disposed of with other household waste. To prevent possible harm to the environment or human health from uncontrolled waste disposal, please separate these items from other types of waste and recycle them responsibly to promote the sustainable reuse of material resources. Household users should contact either the retailer where they purchased this product, or their local government office, for details of where and how they can take these items for environmentally safe recycling. Business users should contact their supplier and check the terms and conditions of the purchase contract. This product and its electronic accessories should not be mixed with other commercial wastes for disposal. This product is RoHS compliant.

Correct disposal of batteries in this product



(Applicable in countries with separate collection systems)

The marking on the battery, manual or packaging indicates that the battery in this product should not be disposed of with other household waste. Where marked, the chemical symbols Hg, Cd or Pb indicate that the battery contains mercury, cadmium or lead above the reference levels in EC Directive 2006/66. If batteries are not properly disposed of, these substances can cause harm to human health or the environment.

To protect natural resources and to promote material reuse, please separate batteries from other types of waste and recycle them through your local, free battery return system.

EU Declaration of Conformity

Hereby, Doro declares that the radio equipment type DWO-0420 (Doro Watch) is in compliance with Directives: 2014/53/EU and 2011/65/EU including delegated Directive (EU) 2015/863 amending Annex II. The full text of the EU declaration of conformity is available at the following internet address: www.doro.com/dofc.

UK Declaration of Conformity

Hereby, Doro declares that the radio equipment type DWO-0420 (Doro Watch) is in compliance with the relevant UK legislation.

The full text of the UK declaration of conformity is available at the following internet address: www.doro.com/dofc

Ecodesign declaration, energy efficiency for external power supply

Hereby, Doro declares the external power supply for this device is in compliance with Commission Regulation (EU) 2019/1782 regarding ecodesign requirements for external power supplies pursuant to Directive 2009/125/EC.

The full information regarding the ecodesign requirements is available at the following internet address: www.doro.com/ecodesign

Specifications

Bluetooth (MHz):	5.0, (2402 - 2480)
Dimensions	
Height:	13 mm
Diameter:	45 mm
Weight:	45 g (including battery)
Battery:	3.8 V / 300 mAh Li-Polymer battery
Display Size:	1.28"
Charging:	5 V, maximum 2 A
Charging time:	Approximate 2 hours
Battery life:	Approximate 8 days
Waterproof:	Water protected (IP68)
Operating ambient temperature:	Min: 0° C (32° F) Max: 60° C (140° F)

DWO-0420 (Doro Watch) (1011)

English

Version 2.0

©2022 Doro AB. All rights reserved.

www.doro.com



REV 21261 – STR