

Clario *Toni*

SUCTION PUMP

- EN Instructions for use
- DE Gebrauchsanweisung
- FR Mode d'emploi
- IT Istruzioni per l'uso
- NL Gebruiksaanwijzing
- SV Bruksanvisning
- FI Käyttöohjeet
- NO Bruksanvisning
- ES Instrucciones de uso
- PT Instruções de utilização



Table of contents

Congratulations	4
1 Warnings and safety instructions	5
Safety instructions	7
2 Power supply and battery operation	8
Battery low	8
Battery empty	8
3 Description	9
Introduction	9
Intended use/indications	9
Contraindications	9
Intended user	9
Intended patient population	9
Important note	9
4 Overview	10
Definition of vacuum	10
Versions of the pump	10
Main elements of the pump	10
Position of the membrane	11
Valve discs in the SafetyChamber	11
Operating elements and battery status	11
5 Installation	12
Check initial delivery	12
6 Preparation for use	13
Checks before use	13
Assembly of the collection system	13
Assembly of the SafetyChamber	14
Attaching the collection system to the pump	14
7 Operating instructions	15
Connect Clario Toni to mains power	15
Functional check with water	16
Alternative: functional check with the optional vacuum gauge	17
Changing vacuum level	18
Placing out of operation after use	18
8 Emptying the canister	19
9 Replacing the valve discs	20

10	Replacing the rechargeable battery	21
11	Battery data and test	22
	Duration of pumping.....	22
	Charging time (charged up to 100%).....	22
	Battery status.....	22
	Testing the rechargeable battery.....	22
12	Battery calibration	23
	Calibrating NiMH rechargeable battery.....	23
	Storage of the rechargeable battery.....	23
13	Troubleshooting	24
	Motor not running.....	24
	Pump is too loud.....	24
	Insufficient vacuum.....	24
	Running time from battery insufficient.....	24
	No LED lit.....	24
	LED lit up.....	24
	LED blinks slowly.....	24
	LED blinks rapidly.....	24
14	Warranty and servicing	25
	Warranty.....	25
	Servicing.....	25
15	Disposal	25
16	Cleaning guidelines	26
	General notes.....	26
	Medela recommended surface cleaning agents for pump housing.....	26
	Water.....	26
	Cleaning/disinfection machines.....	26
	Disposable products.....	26
17	Accessories overview	28
18	Accessories legend	29
19	Signs and symbols	30
20	Technical specifications	32
21	Technical documentation	33
	Technical documentation/EMC.....	326

Congratulations

By choosing the Clario Toni, you have acquired a high-quality suction pump which is adaptable to your needs on order of a health professional/ physician only. This product provides you with a unique threefold hygienic design and optimal protection from an overflow. It is operated by a membrane system with an electric motor. Using the 3 vacuum settings, the suction strength can be adjusted to the required level. As all Medela suction pumps, this pump provides reliable and simple suction. Its simple handling and cleaning as well as the safety features are additional advantages you receive. Contact us – we will be pleased to advise you.

1 Warnings and safety instructions



WARNINGS

Indicates a potentially hazardous situation which, if not avoided, could result in death or serious injury.



CAUTIONS

Indicates a potentially hazardous situation which, if not avoided, could result in minor or moderate injury.



Safety related tip

Indicating useful information about the safe use of the device.

The Clario Toni is approved exclusively for the use as described in these instructions for use. Medela can only warranty the safe functioning of the system when the Clario Toni is used in combination with the original Medela accessories. See chapters 17/18.

Please read and observe these warning and safety instructions before operation. These instructions for use must be kept with the device for later reference.

Please note that these instructions for use are a general guide for the use of the product. Medical matters must be addressed by a physician. Medela considers herself only responsible for the effect on BASIC SAFETY, reliability and performance of the Clario Toni if it is used in accordance with the instructions for use.

CAUTION: U.S. Federal law restricts this device to sale by or on the order of a physician.

Subject to change.



WARNINGS

- For use only by medically trained persons who have been adequately trained in suction procedures and in the use of aspirators.
- For patients for whom a breakdown of the device can lead to a critical situation (e.g. patients with acute dyspnoea or severe catarrhal congestion), a replacement device must always be available.
- The device must not be used for suctioning explosive, easily flammable or corrosive liquids.
- The connecting tubing supplied with the device must never come into direct contact with the suction area. A sterile suction catheter must always be used (risk of infection).
- Before cleaning the device, pull the plug out of the fixed mains socket.
- No modification of this equipment is allowed.
- Do not connect this device to a passive drainage tube.
- Consult the indications for use and consider risk factors and contraindications before using the Clario Toni. Failure to read and follow all instructions in this manual prior to use may result in serious or fatal injury of the patient.
- Do not use Clario Toni in MRI environment (Magnetic Resonance Imaging).
- The power supply may be damaged through electrostatic discharge (ESD) events at the DC port of 15kV.



CAUTIONS

- Incorrect use can cause pain and injury to the patient.
- Do not use sterile accessories when the sterile packaging is damaged.
- Wireless communications equipment such as wireless home network devices, mobile phones, cordless telephones and their base stations, walki-talkie can affect the Clario Toni and should be kept at least a distance 1ft (30 cm) away from the equipment.
- Portable and mobile RF communications equipment can affect medical devices.



Safety related tip

- For safety tests, it is assumed that the device is serviced and repaired throughout its service life in accordance with the service manual. Because the Clario Toni is a device of safety class II (EN IEC 60601-1, A1, A2:1995), the safety tests are confined to visual inspection of the housing and power cord. This test must be carried out before each use.
- Testing the patient leakage current: Please see service manual for details.
- The protection of the Clario Toni against the effects of the discharge of a cardiac defibrillator is dependent upon the use of appropriate cables.
- Separation from the mains is only assured through the disconnection of the mains plug and the fixed mains socket.
- Before you plug in the device, please check that your local power supply is the same as the voltage given on the specification plate.

Safety instructions

- The Medela Clario Toni is a medical device that requires special safety measures in regard to EMC. It must be installed and put into operation in accordance with the attached EMC information.
- In each of the following cases, the device must not be used and it must be repaired by Customer Services:
 - if the power cord or the plug are damaged
 - if the device is not functioning perfectly
 - if the device is damaged
 - if the device shows clear safety defects.
- Keep the power supply cord away from hot surfaces.
- The mains plug and the on/off switch must not come into contact with moisture.
- Never pull the mains plug out of the fixed mains socket by pulling on the power supply cord!
- Never leave the device unattended when it is switched on.
- The pump must stand upright during use.
- Never place the power supply cord around your neck.
- Never use the device at high room temperatures, while bathing or showering, if you are very tired or in an environment where there is a risk of explosion.
- Never place the device in water or other liquids.
- When using single use, sterile products, please note that they are not intended to be reprocessed. Reprocessing could cause loss of mechanical, chemical and/or biological characteristics. Reuse could cause cross contamination.
- Contact your local Medela customer service representative for assistance with product operations.
- Wear gloves for all operations.

These instructions for use must be kept for later reference.

2 Power supply and battery operation

The Clario Toni is a mains- and battery powered suction pump. Before you plug in the device, please check that your local power supply is the same as the voltage given on the specification plate. Used as described in this user guide, the Clario Toni AC/DC model has a maximum of 50 minutes of battery time before it is necessary to recharge. If the Clario Toni AC/DC model is not in use, the battery must be calibrated every 60–90 days.

Battery low

During battery operation a slow blinking of the LED indicator indicates, that the rechargeable battery is soon discharged. The function of the Clario Toni is maintained for a short time (~10 minutes), but the battery must be recharged as soon as possible.

Battery empty

As soon as the rechargeable battery is empty, the pump comes to a stop. The proper function of the pump is no longer maintained. The rechargeable battery must be recharged or replaced.

3 Description

Introduction

The Clario Toni is a high-quality suction pump. It is powered by the well-proven membrane system. It ideally combines easy handling and cleaning with safety features to ensure optimal operation. Use only according to the instructions from your doctor and after getting instructions from trained medical specialists.

Intended use

The Clario Toni suction pumps are indicated for aspiration and removal of secretions, bodily fluids and foreign objects from a patient's airway or respiratory support system in the nasal, pharyngeal and tracheal areas of pediatric and adult patients. The suction pump is suitable for use at home, in the hospital, in the car or outdoors.

Indications

The Clario Toni suction pump is indicated to clear the airways either through the nose, mouth or tracheostomy tube.

Contraindications

The device is not suitable for use for prolonged suctioning.

Intended user

The Clario Toni should only be operated by properly instructed users. These persons must not be hard of hearing or deaf and must have adequate visual faculty. The instruction has to be refreshed at least once a year.

Intended patient population

The Clario Toni is intended to be used on patients only exhibiting conditions as described in the indications for use.

Important note

Compliance with proper surgical procedures and techniques is the responsibility of the physician. Each physician must evaluate the appropriateness of the treatment based on his own knowledge and experience.

4 Overview

Definition of vacuum

By the application of medical aspiration devices, vacuum is normally given as the difference (in absolute figures) between absolute pressure and atmospheric pressure or as negative values in Kilopascal (kPa). In this document, the indication of -10 kPa for example always refers to a pressure range in kPa below atmospheric ambient pressure (according to EN ISO 10079:1999).

Versions of the pump



Clario Toni AC/DC

Main elements of the pump



Position of the membrane



Valve discs in the SafetyChamber

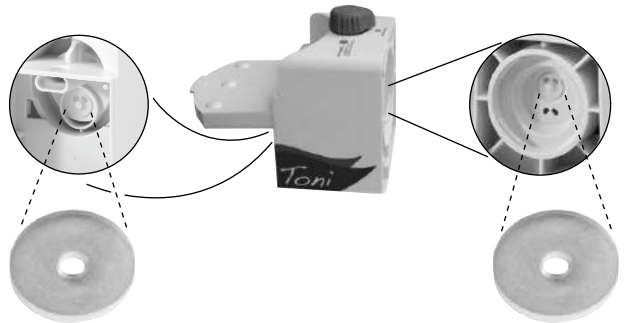

Operating elements and battery status



Vacuum regulator

On/off button

Rechargeable battery LED

- not lit** Battery is fully charged
- lit up**
 - Battery is being charged
 - Pump is plugged in
- blinks slowly** Battery is soon empty
- blinks rapidly** Battery is defective

5 Installation

Check initial delivery

Check the delivery package of the Clario Toni for completeness and general condition.



Clario Toni versions

REF	Clario Toni AC/DC	014.00XX
	Clario Toni Deluxe	014.00XX



Disposable fingertip tubing

REF 074.0003



Power adapter

REF 014.0004

Power cord

099.0011 (Euro)
014.0007 (UK)
014.0008 (AUS/NZ)
099.0014 (USA)



Instructions for use

REF 200.8400



WARNINGS

The connecting tubing supplied with the device must never come into direct contact with the suction area. A sterile suction catheter must always be used (risk of infection).

6 Preparation for use



WARNINGS

For use only by medically trained persons who have been adequately trained in suction procedures and in the use of aspirators. Wear gloves for all operations.



CAUTIONS

- The Clario Toni must remain in an upright position during use.
- Sterile accessories must be checked on the integrity of the packaging before use.
- Non sterile and reusable accessories must be cleaned, disinfected and/or sterilized according to the Medela cleaning guide (product code 200.2391).

6.1 Checks before use

- Check the Clario Toni system before use for damage of the power cord or plug, obvious device damage or safety defects and proper functioning of the device.
- Check for completeness and general condition of the Clario Toni delivery package.
- Make sure that the rechargeable battery is calibrated according to chapter 12.
- Check all accessories prior to use:
 - Canister and lid for cracks, brittle and flawed spots. Replace if necessary.
 - Tubing for cracks, brittle areas and that connectors are firmly attached. Replace if necessary.

6.2 Assembly of the canister





- 1.1 Attach the floater to the canister.



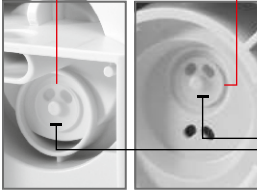

- 2.1 Attach the lid to the canister. Mind the markings on the front of the canister and the lid.

6.3 Assembly of the SafetyChamber

1.  1.1 Open the lid of the SafetyChamber.
2.  2.1 Make sure that both valves (silicone discs) are attached to the SafetyChamber. See chapter 4.
3.  3.1 Make sure that the lid of the SafetyChamber is closed well.
4.  4.1 Hold the SafetyChamber and tilt 45° to the left to attach it to the motor unit.
4.2 Turn the SafetyChamber to an upright position until you hear a click.

6.4 Attaching the canister to the pump

1.  1.1 Attach the canister to the pump. Press firmly.
2.  2.1 Attach the disposable fingertip tubing to the suction port.

7 Operating instructions



CAUTIONS

The Clario Toni is to be set up in such a way, that a separation from the mains supply can be easily managed. Calibrate the rechargeable battery before the first use.



WARNINGS

For use only by medically trained persons who have been adequately trained in suction procedures and in the use of aspirators. Wear gloves for all operations.

7.1 Connect Clario Toni to mains power

1. Check the pump before use following the instruction in chapter 6.1.

2. **If the pump is connected to a fixed mains socket:**

Plug in the mains plug of the power cord to a fixed mains socket.

or

If the pump is operated with a 12 VDC power source:

Connect the optional 12 VDC connection cable to the pump and to the 12 VDC power source.

or

If the pump is operated with the rechargeable battery:

No connection to a power source is needed. Make sure that the battery was charged for five hours.

7.2 Functional check with water

1.

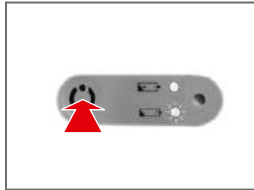

1.1 Press the On/off button to switch on the pump.

2.

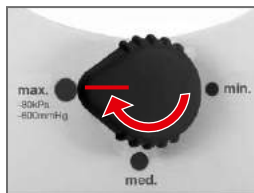

2.1 Set vacuum regulator to position "max.".

3.

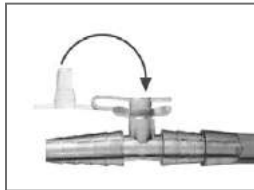

3.1 Attach the fingertip tubing.
See chapter 6.4, step 2.1.
3.2 Plug fingertip port.

4.

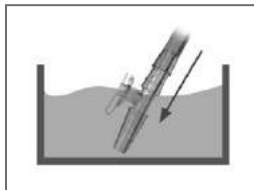

4.1 Place fingertip into water and check if there is suction.

5. If there is suction, proceed with step 6. If not, see chapter 13.

6. Use catheter and vacuum setting as prescribed by a physician.

7.3 Alternative: functional check with the optional vacuum gauge

1.



1.1 Attach the optional vacuum gauge to the suction port.

2.

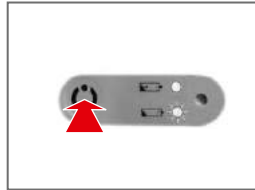

2.1 Press the On/off button to switch on the pump.

3.

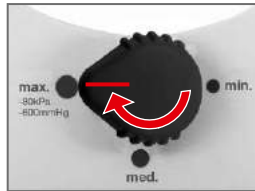

3.1 Set vacuum regulator to position "max.".

Altitude above sea level:	Max. Vacuum:
+ 2000 m	- 63 kPa - 471 mmHg
+ 1000 m	- 71 kPa - 532 mmHg
+ 500 m	- 76 kPa - 566 mmHg
0 m	- 80 kPa - 600 mmHg

(Tolerance: - 15%)

4.



4.1 Compare the vacuum with the values in the table on the left.

5. If the vacuum is ok, proceed with step 6. If not, see chapter 13.

6. Attach the fingertip tubing.

7. Use catheter and vacuum setting as prescribed by a physician.



WARNINGS

For use only by medically trained persons who have been adequately trained in suction procedures and in the use of aspirators. Wear gloves for all operations.

7.4 Changing vacuum level

1.

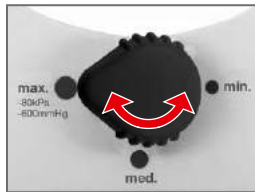

1.1 Set vacuum regulator to the necessary position.

7.5 Placing out of operation after use

1.

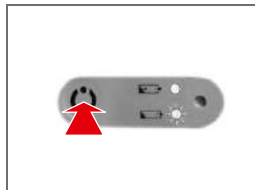

1.1 Press the On/off button to switch off the pump.

2. **If the pump is connected to a fixed mains socket:**

Disconnect the mains plug from the fixed mains socket.

or

If the pump is connected to a 12 VDC power source:

Disconnect the 12 VDC plug from the 12 VDC power source.



3. Clean and disinfect the Clario Toni. See chapter 16.

8 Emptying the canister

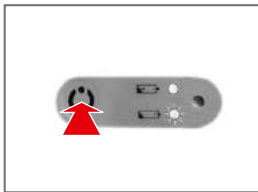

Safety related tip

On a daily basis or latest when the fluid level reaches 550 ml and the floater stops suction into the canister the canister should be emptied.

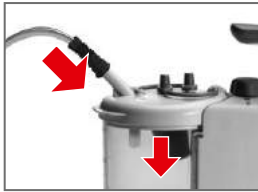
1.  1.1 Press the On/off button to switch off the pump.
2.  2.1 Disconnect the disposable fingertip tubing from the suction port.
2.2 Remove canister from the pump.
3.  3.1 For transportation always seal the canister with the plugs.
4. Empty canister and dispose of fingertip tubing in accordance with local guidelines and inhouse guidelines.
5.  5.1 Attach a clean canister.
5.2 Attach a new disposable fingertip tubing to the suction port.
6. Switch on the pump and set the vacuum as prescribed by a physician.

9 Replacing the valve discs

- 1.  1.1 Remove the canister.

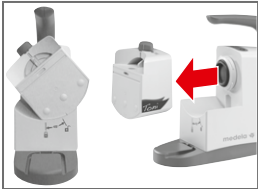
- 2.  2.1 Turn SafetyChamber 45° to the left.
2.2 Remove SafetyChamber by pulling it off the pump.

- 3.  3.1 Open the SafetyChamber.

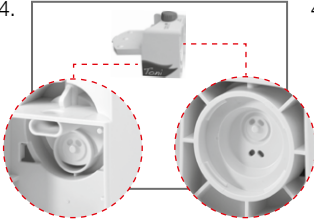
- 4.  4.1 Replace defective valve discs. Make sure that the new valve discs are attached correctly.

- 5. Attach the SafetyChamber to the pump as described in chapter 6.3.

10 Replacing the rechargeable battery



WARNINGS

Before replacing the rechargeable battery, switch off the Clario Toni and pull the mains plug from Clario Toni out of the fixed mains socket.

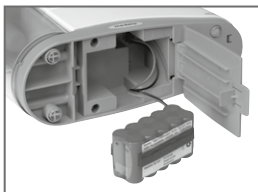
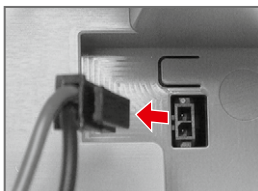
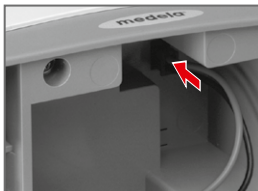

Before this operation, pull the mains plug out of the fixed mains socket.

1.  1.1 Open the lid of the battery compartment on the bottom of the Clario Toni.
2.  2.1 Detach the battery cable by pulling the plug.
3. Remove the old rechargeable battery.
4. Insert the new rechargeable battery.
5.  5.1 Reattach the battery cable by plugging in the plug.
6. Close the lid of the battery compartment. Make sure that the lid is closed well and that the battery cable is not clamped or pinched.
7. Calibrate and test the rechargeable battery (see chapters 11 / 12).

11 Battery data and test



CAUTIONS

Only charge the rechargeable battery when the charging indicator blinks slowly.

Duration of pumping

If the battery is fully charged, the operating time at maximum vacuum is approximately > 50minutes.

Charging time (charged up to 100%)

Approx. 5 hours

Battery status

- not lit** Battery is fully charged
- lit up**
 - Battery is being charged
 - Pump is plugged in
- blinks slowly** Battery is soon empty
- blinks rapidly** Battery is defective

Testing the rechargeable battery

1. Make sure that the rechargeable battery is fully charged.
2. Pull out the mains plug from the fixed mains socket.

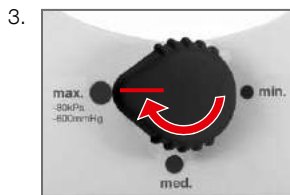

3.1 Set vacuum regulator to position "max.".

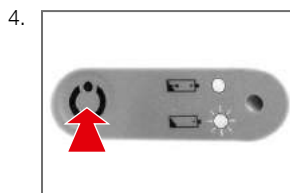

4.1 Switch on the Clario Toni. The pump will start running.

5. Measure the time until the pump comes to a stop. The battery is ok, when the running time is > 50minutes.

If the running time is < 50 minutes, repeat test or calibrate the battery (see next page).

12 Battery calibration



CAUTIONS

Calibrate the rechargeable battery before first use and after storage duration > 2 months. Replace battery if the calibration is not successful.

Calibrating NiMH rechargeable battery

1. Make sure that the rechargeable battery is fully charged.
2. Pull out the mains plug from the fixed mains socket.

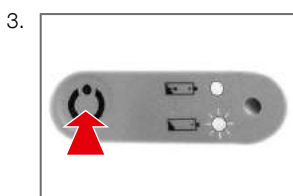

- 3.1 Switch on the Clario Toni. The pump will start running.

4. Let the pump run until the rechargeable battery is empty and the pump comes to a stop.
5. Connect the Clario Toni to a fixed mains socket. The rechargeable battery is being charged.
6. Wait until the charging indicator goes out.
7. Repeat step 1 to 6. The Clario Toni AC/DC is then ready to use.

Storage of the rechargeable battery

In order to keep the self-discharge at a minimum, store the Clario Toni and the removed replacement rechargeable batteries at temperatures below 25 °C (77 °F). Repeat the calibration process every 60–90 days.

13 Troubleshooting

Motor not running

Check if:

- the Clario Toni is switched on.
- the mains voltage is correct and if the mains plug is inserted correctly into the fixed mains socket.
- the internal battery is charged.

Pump is too loud

Check the position and seal of the valve discs inside the SafetyChamber.

Insufficient vacuum

Check if:

- the vacuum regulator is set correctly.
- the tubings are not defective or broken. If necessary, replace.
- all plug-in connections are tight.
- the suction canister/lid have no cracks, brittle areas, discolouration. If necessary, replace.
- the seal of the valve discs inside the SafetyChamber is tight.
- the membrane is clean and has no tears.

Running time from battery insufficient

Calibrate the rechargeable battery. See chapter 12.

No LED lit

The rechargeable battery is fully charged.

LED lit up

- The rechargeable battery is being charged.
- Pump is plugged in.

LED blinks slowly

The rechargeable battery is soon empty. The battery power is sufficient for about 10 minutes of pumping.

LED blinks rapidly

The rechargeable battery is defective. For replacing the defective battery see chapter 10.

14 Warranty and servicing

Warranty

Medela AG warrants the device will be free from defects in materials and workmanship for a period of 2 years (6 months for the rechargeable battery) from the date of delivery.

Faulty material will be replaced free of charge during this period if not resulting from abuse or misapplication. This will not apply to parts subject to wear and tear in use. To ensure compliance with this warranty as well as optimum service from Medela products, we recommend the exclusive use of Medela accessories with our appliances.

In no event shall Medela AG be liable for claims which exceed the scope of warranty described including liability for consequential damages, etc. The right to the replacement of faulty parts will not be recognized by Medela if any work has been carried out on the pump by unauthorized persons. This warranty is subject to the appliance being returned to a Medela service centre.

Servicing

Service work is only to be carried out by positions authorised by Medela. The Medela service manual is available upon request.

15 Disposal

The Clario Toni comprises metals and plastics and should be disposed of in accordance with the European directives 2011/65/EU and 2012/19/EU. Additional, local guidelines must also be observed. With the AC/DC versions, the electronic components and the rechargeable battery must be disposed of separately, in accordance with the local regulations.

Please take care that you dispose the Clario Toni and its accessories in accordance with your local disposal guidelines.



User information for the disposal of electrical and electronic equipment

This symbol means that the electrical and electronic equipment must not be disposed as normal household refuse. A correct disposal of this device protects and prevents possible damage to the environment or human health. For more information about the disposal contact the manufacturer, your local caregiver or healthcare provider. This symbol is only valid in the European Union. Please respect the relevant state laws and rules in your country for the disposal of electrical and electronic equipment.

16 Cleaning guidelines



WARNINGS

After each use, the parts that had been in contact with the aspirated secretions are to be cleaned, disinfected, sterilised or disposed of **according to the table on the next page**.



Before cleaning the device, pull the mains plug out of the fixed mains socket.

General notes

- These are general recommendations only that may be adjusted individually, based on the hospital's specific directives and cleaning practices and policies.
- Detailed information according to Medela cleaning instructions (product code 200.2391).
- Wear protective gloves for cleaning/disinfection.
- Dispose of fluids such as blood and secretions and the parts contaminated with them in accordance with internal hospital guidelines.

Medela recommended surface cleaning agents for pump housing

- **CaviWipes**, Metrex Research, www.sybrondental.com
- **mikrozyd® AF wipes**, Schülke&Mayr GmbH, www.schuelke.com

Water

Use only the purest quality of water for cleaning. Water hardness is a serious consideration since deposits left on medical products may not be properly decontaminated. Use deionised water in order to reduce this problem. The final rinse water is bacterial free and contains no endotoxins.

Cleaning/disinfection machines

Can be used to disinfect parts from the table on the next page. A hot water rinse (maximum temperature 100°C) may provide a medium-to high level of disinfection. Every section of the constituent parts must be accessible in order to ensure efficient cleaning. We recommend using a cleaning/disinfecting machine that has been approved by the Robert Koch- Institute and complies with ISO 15883. Recommended temperature for noncritical medical devices (i.e. those that only come into contact with uninjured skin) is 90°C for 1 minute. The time is increased to 5 minutes for all medical devices that are considered to be critical.



Disposable products

These are single use products not intended to be reprocessed. Reprocessing could cause loss of mechanical, chemical and/or biological characteristics. Reuse could cause cross contamination.

Canister, SafetyChamber	Pump housing Mains cable	
x	x	<p>1. Disassembly Separate all individual parts before cleaning, disinfecting and sterilising.</p>
x		<p>2. Cleaning canister, SafetyChamber Clean components in hot water (60–70 °C) containing a detergent with a pH range between 6.0 and 8.0 only, in order to avoid damaging the instruments and containment devices. Enzymatic detergents help with the removal of organic matter, such as blood. Detergents should be used according to their manufacturer's recommended concentration levels. Some alkaline detergents have been formulated to be safe for reprocessing medical devices. The manufacturers of these detergents should provide information about specific materials that may be damaged by their detergents. Soak all parts thoroughly with warm, soapy water or in enzymatic detergent for 1–5 minutes.</p> <p>1. Remove visible dirt with a cleaning tool – general purpose cleaning brushes, such as pipe cleaners or non-abrasive lint cloths. Brushes and pipe cleaners should fit snugly but still be able to be moved around easily within the area to be cleaned. Rinse thoroughly in clear water. Allow to dry</p> <p>2. Check the instruments for visible dirt and repeat these steps if necessary.</p>
	x	<p>3. Cleaning pump housing, mains cable Wipe with detergent mentioned above. Use clean cloth to dry.</p>
x		<p>4. Disinfect Soak at room temperature for 30 minutes in a disinfection/cleaning solution (A). After the reaction time, use water to rinse the solution residue from the individual parts and rinse the tubing. Rinse for at least 2 minutes with the cleaning solution (B).</p> <p>(A) fluid aldehyde-free disinfection solution with cleaning effect for use as a soaking bath, bactericide, fungicide, limited virucide, with good material compatibility for stainless steel, non-ferrous material and plastics including silicone, slightly alkaline. e.g. 2% neodisher® Septo MEDsolution</p> <p>(B) Fluid, pH-neutral, enzymatic cleaning solution for the treatment of instruments by machine or manually with very good material compatibility for stainless steel, non-ferrous material and plastics including silicone.</p> <p>or use cleaning/desinfecting machine. or use a dishwasher.</p>
x		<p>5. Storing components After disinfection store the components on a clean and dry cloth.</p>

17 Accessories overview



WARNINGS

Clario Toni was verified in combination with the accessories listed below. For a correct and safe operation use Clario Toni with these accessories only. Further information is supplied on the instruction sheet of the individual accessory.

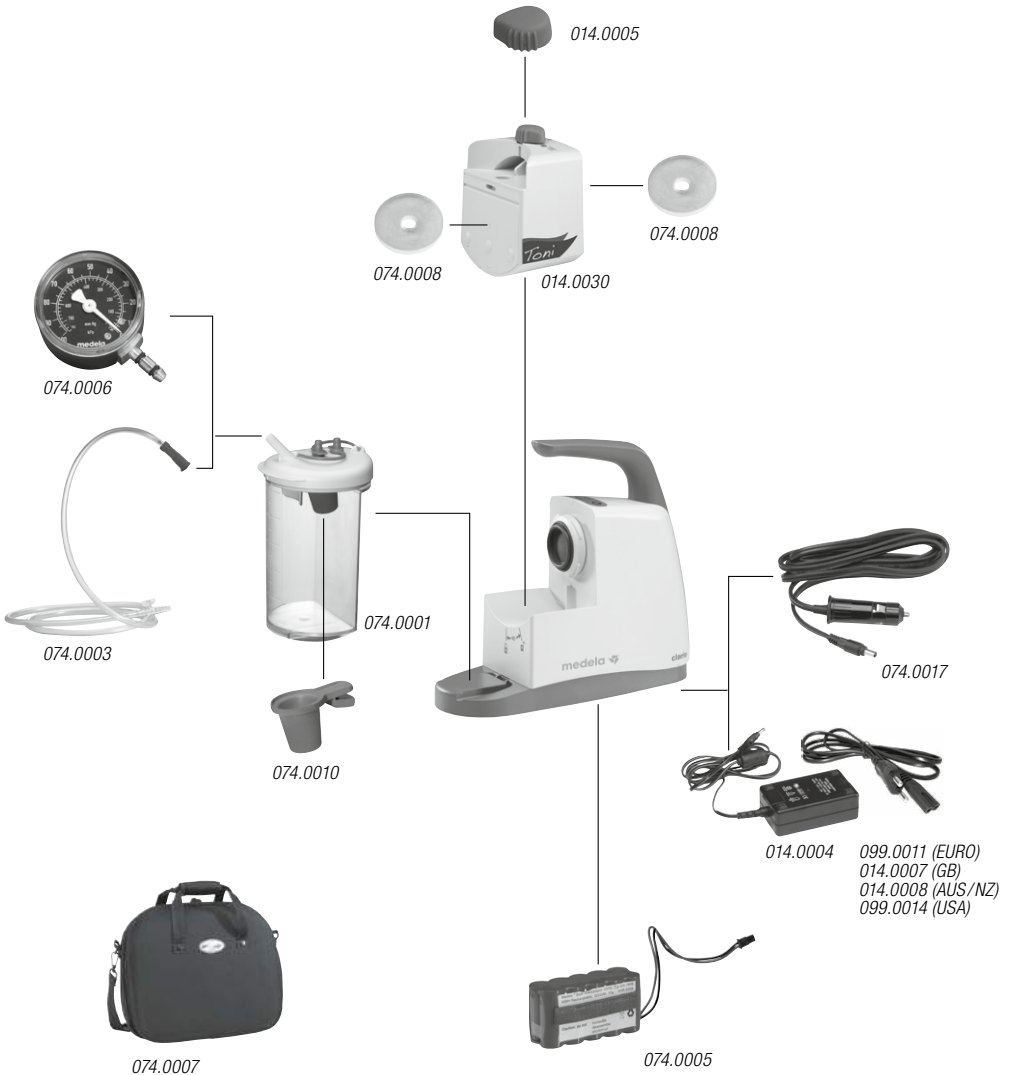

18 Accessories legend



Safety related tip

If the pump is used together with non-Medela applied parts, they must:

- have CE mark and (if necessary) local registration
- be able to be attached to Medela accessories safely without impacting the performance of the pump.

Note: when combining Medela parts and non-Medela parts, you take over the responsibility of the entire system.

REF

014.0030	SafetyChamber
014.0005	Vacuum regulator
074.0008	Valve discs (10 pcs.)
074.0001	Canister set
074.0010	Floater (10 pcs.)
074.0003	Disposable fingertip tubing
074.0005	Rechargeable battery
014.0004	Power adapter
099.0011	Power cord (EURO)
099.0014	Power cord (USA)
014.0007	Power cord (GB)
074.0007	Carrying bag
074.0017	Car connection cable for 12V DC
074.0006	Vacuum gauge

19 Signs and symbols



This symbol indicates the compliance with the essential requirements of the Council Directive 93/42/EEC of 14 June 1993 concerning medical devices.



This symbol indicates the class of the pump.



This symbol indicates a class II device.

IP21 This symbol indicates the protection against harmful effects due to ingress of solid foreign objects and against harmful effects due to the ingress of water.



This symbol indicates that the device should not be used after the end of the year and month shown.



This symbol indicates a single use device. Do not reuse the device.



This symbol indicates the compliance with additional USA and Canada safety requirements for medical electrical equipment.



This symbol indicates manufacturer's catalogue number.



This Symbol indicates a type BF applied part.



This symbol indicates manufacturer's serial number.



This symbol indicates the legal specifications of the pump.



This symbol indicates MR UNSAFE.



This symbol indicates manufacturer's batch code.



This symbol indicates to follow instructions for use.



This symbol indicates that interferences may occur in the vicinity of equipment marked with this symbol.



This symbol indicates the device is sterilized using ethylene oxide.



This symbol indicates to consult instructions for use.



This symbol indicates the manufacturer.



This symbol indicates the temperature limitation for operation, transport and storage.



This symbol indicates a CAUTION or WARNING associated with the device.



This symbol indicates the date of manufacture (four digits for the year and two digits for the month).



This symbol indicates the humidity limitation for operation, transport and storage.



This symbol indicates safety related tip.



This symbol indicates the atmospheric pressure limitation for operation, transport and storage.



This symbol indicates to keep the device dry.

pcs This symbol indicates number of items.



This symbol indicates do not use the device if package is damaged.



This symbol indicates the maximum vacuum level of the pump.



This symbol indicates the number of items n that the content is sufficient for.



This symbol indicates the flow levels of the pump.



This symbol indicates the electrical specifications of the pump.



This symbol indicates do not dispose the device together with unsorted municipal waste (for EU only).



This symbol indicates alternating current.



This symbol indicates direct current.



This symbol indicates that the material is part of a recovery/recycling process.



This symbol indicates the weight of the pump.



This symbol indicates a carton package.



This symbol indicates the dimensions (h x w x d) of the pump.



This symbol indicates to keep the device away from sunlight.



This Symbol indicates a Prescription Device. CAUTION: U.S. Federal law restricts this device to sale by or on the order of a physician (for US only).



This symbol indicates to handle the fragile device with care.

20 Technical specifications



min. vacuum, - 70 mmHg / - 9 kPa (+/- 20 mmHg / +/- 2.6 kPa)
med. vacuum, - 115 mmHg / - 15 kPa (+/- 30 mmHg / +/- 4 kPa)
max. vacuum, - 600 mmHg / - 80 kPa (- 90 mmHg / - 12 kPa)

Calculated at 0m, atmospheric pressure: 1013hPa
Please note: vacuum levels may vary depending on location
(meters above sea level, atmospheric pressure and temperature).



low flow: 15l/min. (+/- 10%)



2.0 kg / 4.4 lbs
Without jar



100-240 V, 50-60 Hz
12 V, 3.4 A, NiMH
Power adapter
UE48-120340SPA1



ISO 13485
93/42 EEC Class IIa



h x w x d
223 x 255 x 95 mm



Transport/ Storage Conditions



Transport/Storage
Rechargeable battery



Operating Conditions



IP21

21 Technical documentation



WARNINGS

Do not use other accessories than those specified or sold by the manufacturer as replacement parts for internal components as it may result in increased emissions or decreased immunity of the Clario Toni pump.

HF (high-frequency) surgical equipment, radio networks or the like can influence the operation of the device and may not be operated in combination with the Clario Toni.

EMC

Clario Toni is EMC-tested in conformity with the requirements of IEC 60601-1-2:2007 and IEC 60601-1-2:2014 4th Edition according clause 7 and 8.9.

Clario Toni is a medical device that requires special safety precautions and must be installed and placed in operation in accordance with the attached EMC information.

See also pages 326–329.

Inhaltsverzeichnis

Herzlichen Glückwunsch	36
1 Warn- und Sicherheitshinweise	37
Sicherheitshinweise	39
2 Stromversorgung und Akku-Betrieb	40
Akku fast leer.....	40
Akku leer	40
3 Beschreibung	41
Einleitung	41
Bestimmungsgemäße Verwendung/Indikationen	41
Kontraindikationen	41
Vorgesehene Benutzer	41
Patientenzielgruppe	41
Wichtiger Hinweis	41
4 Übersicht	42
Definition von Vakuum.....	42
Versionen der Pumpe	42
Hauptbestandteile der Pumpe.....	42
Position der Membran	43
Ventilscheiben in der Sicherheitskammer.....	43
Bedienelemente und Ladezustand des Akkus	43
5 Installation	44
Lieferumfang überprüfen	44
6 Anwendung vorbereiten	45
Tests vor Gebrauch	45
Montage des Behälters	45
Montage der Sicherheitskammer	46
Behälter an der Pumpe anbringen	46
7 Betriebsanweisungen	47
Die Clario Toni mit dem Stromnetz verbinden	47
Funktionstest mit Wasser	48
Alternative: Funktionstest mit dem optionalen Manometer.....	49
Vakuumstärke ändern.....	50
Außerbetriebnahme nach Gebrauch	50
8 Behälter leeren	51
9 Ventilscheiben ersetzen	52

10 Akku ersetzen	53
11 Akku-Daten und Test	54
Dauer des Absaugens	54
Ladezeit (bis 100% Ladung)	54
Akku-Ladezustand	54
Akku testen.....	54
12 Akku kalibrieren	55
NiMH-Akku kalibrieren	55
Lagerung des Akkus	55
13 Problembehebung	56
Motor läuft nicht	56
Pumpe ist zu laut	56
Ungenügendes Vakuum	56
Ungenügende Laufzeit des Akkus.....	56
LED leuchtet nicht	56
LED leuchtet	56
LED blinkt langsam.....	56
LED blinkt schnell	56
14 Garantie und Wartung	57
Garantie	57
Wartung	57
15 Entsorgung	57
16 Richtlinien für die Reinigung	58
Allgemeine Hinweise.....	58
Medela empfiehlt folgende Oberflächenreiniger für das Pumpengehäuse.....	58
Wasser.....	58
Reinigungs-/Desinfektionsgeräte	58
Einweg-Artikel.....	58
17 Zubehörübersicht	60
18 Zubehörliste	61
19 Zeichen und Symbole	62
20 Technische Daten	64
21 Technische Dokumentation	65
Technische Dokumentation/EMC	326

Herzlichen Glückwunsch

Mit der Clario Toni Pumpe haben Sie eine qualitativ hochwertige Absaugpumpe gewählt, die sich gemäß der Anordnung von Pflegefachkräften/Ärzten auf Ihre Bedürfnisse einstellen lässt. Dieses Produkt bietet Ihnen ein einzigartiges dreifaches Hygienekonzept und einen optimalen Schutz vor Überlauf. Das Membran-System arbeitet mit einem elektrischen Motor. Sie können mit den drei Vakuumeinstellungen die Saugstärke auf das gewünschte Niveau einstellen. Wie alle Medela Absaugpumpen bietet die Clario Toni zuverlässiges und einfaches Absaugen. Die einfache Handhabung und Reinigung sowie die Sicherheitsvorkehrungen sind weitere Pluspunkte. Kontaktieren Sie uns – wir beraten Sie gerne.

1 Warn- und Sicherheitshinweise



ACHTUNG

Weist auf eine potenziell gefährliche Situation hin, die zum Tod oder zu ernsthaften Verletzungen führen kann.



VORSICHT

Weist auf eine potenziell gefährliche Situation hin, die zu mittleren bis kleineren Verletzungen führen kann.



Sicherheitshinweis

Weist auf nützliche Informationen zum sicheren Gebrauch des Geräts hin.

Die Clario Toni ist ausschließlich zur in dieser Gebrauchsanweisung beschriebenen Verwendung zugelassen. Medela kann die sichere Funktion des Systems nur gewährleisten, wenn die Clario Toni in Kombination mit dem Medela Originalzubehör verwendet wird. Siehe Kapitel 17 und 18.

Vor Inbetriebnahme bitte diese Warn- und Sicherheitshinweise lesen und beachten. Diese Gebrauchsanweisung muss für den späteren Gebrauch aufbewahrt werden.

Bitte beachten Sie, dass diese Gebrauchsanweisung allgemeine Angaben zur Verwendung des Produktes enthält. Zur Klärung medizinischer Fragen wenden Sie sich bitte an einen Arzt. Medela betrachtet sich für die GRUNDSICHERHEIT, Zuverlässigkeit und Leistungsfähigkeit der Clario Toni nur dann verantwortlich, wenn die Pumpe gemäß dieser Gebrauchsanweisung verwendet wird.

VORSICHT: Nach US-Bundesgesetz darf dieses Gerät nur von Ärzten oder auf deren Anweisung verkauft werden.

Änderungen vorbehalten.



ACHTUNG

- Nur zur Anwendung durch medizinisch geschultes Personal, das in der Durchführung von Absaugtechniken und im Einsatz von Absauggeräten ausreichend geschult ist.
- Bei Patienten, bei denen ein Ausfall des Gerätes zu einer kritischen Situation führen kann (z. B. Patienten mit akuter Atemnot oder starker Verschleimung), muss ein Ersatzgerät bereitstehen.
- Das Gerät darf nicht zum Absaugen explosiver, leicht entflammbarer oder ätzender Flüssigkeiten verwendet werden.
- Der mit dem Gerät gelieferte Anschluss Schlauch darf niemals mit dem Absaugbereich in direkten Kontakt kommen. Es muss immer ein steriler Saugkatheter verwendet werden (Infektionsrisiko).
- Vor der Reinigung des Geräts ist der Netzstecker aus der Steckdose zu ziehen.
- Das Gerät darf nicht verändert werden.
- Das Gerät nicht an eine Schwerkraftdrainage anschließen.
- Lesen Sie die Anwendungshinweise und ziehen Sie Risikofaktoren und Kontraindikationen in Betracht, bevor Sie die Clario Toni verwenden. Ohne gründliche Lektüre und Befolgung der Anweisungen in dieser Anleitung kann die Anwendung zu schwerwiegenden oder tödlichen Verletzungen des Patienten führen.
- Clario Toni nicht im MRT-Umfeld (Magnetresonanztomographie) benutzen.
- Das Netzteil kann bei elektrostatischen Entladungen (ESD) von 15 kV am DC Anschluss beschädigt werden.



VORSICHT

- Fehlerhafte Anwendung kann dem Patienten Schmerzen und Verletzungen zufügen.
- Verwenden Sie kein steriles Zubehör, dessen sterile Verpackung beschädigt wurde.
- Drahtlose Kommunikationsgeräte wie drahtlose Heimnetzwerke, Mobiltelefone, schnurlose Telefone und deren Basisstationen sowie Sprechfunkgeräte können die Funktionsweise der Clario Toni beeinträchtigen und sollten mit einem Mindestabstand von 30 cm (1 Fuß) vom Gerät ferngehalten werden.
- Tragbare und mobile HF-Kommunikationsgeräte (Mobiltelefone) können medizinische Geräte beeinflussen.



Sicherheitshinweis

- Für die sicherheitstechnischen Kontrollen wird davon ausgegangen, dass das Gerät während seiner Lebensdauer gemäß den Serviceanweisungen gewartet und repariert wird. Die sicherheitstechnischen Kontrollen beschränken sich auf die visuelle Inspektion des Gehäuses und Stromkabel, da die Clario Toni ein Gerät der Schutzklasse II (EN IEC 60601-1, A1, A2:1995) ist. Dieser Test muss vor jedem Gebrauch durchgeführt werden.
- Den Patientenableitstrom prüfen: Bitte in den Serviceanweisungen nachschlagen.
- Der Schutz der Clario Toni gegen die Auswirkungen einer Defibrillatorentladung hängt von der Verwendung geeigneter Kabel ab.
- Die Trennung von der Netzspannung erfolgt einzig durch Herausziehen des Steckers aus der Steckdose.
- Bevor Sie das Gerät anschließen, kontrollieren Sie bitte, ob die auf dem Typenschild angegebene Spannung Ihrer hausinternen Spannung entspricht.

Sicherheitshinweise

- Die Medela Clario Toni ist ein medizinisches Gerät, welches spezielle Sicherheitsmaßnahmen betreffend EMV bedingt. Die Clario Toni muss gemäß den beiliegenden EMV-Informationen installiert und in Betrieb genommen werden.
- In den folgenden Fällen darf das Gerät nicht in Betrieb genommen werden, sondern muss vom Kundendienst repariert werden:
 - wenn Stromkabel oder Stecker beschädigt sind,
 - wenn das Gerät nicht einwandfrei funktioniert,
 - wenn das Gerät beschädigt ist,
 - wenn das Gerät andere offensichtliche Sicherheitsmängel aufweist.
- Stromkabel nicht mit heißen Flächen in Berührung bringen.
- Stecker und Ein/Aus-Schalter dürfen nicht mit Feuchtigkeit in Berührung kommen.
- Den Stecker niemals durch Ziehen am Stromkabel aus der Steckdose ziehen.
- Eingeschaltetes Gerät nie unbeaufsichtigt lassen.
- Während des Gebrauches muss die Pumpe aufrecht stehen.
- Legen Sie das Stromkabel nie um Ihren Hals.
- Das Gerät nie in Gebrauch nehmen bei hohen Zimmertemperaturen, beim Baden oder Duschen, wenn Sie sehr müde sind oder in explosionsgefährdeter Umgebung.
- Das Gerät nie in Wasser oder andere Flüssigkeiten stellen.
- Sterile Einweg-Produkte sind nicht für die Wiederverwendung vorgesehen. Eine erneute Verwendung könnte zum Verlust der mechanischen, chemischen und/oder biologischen Eigenschaften führen. Wiederverwendung kann zu einer Kreuzkontamination führen.
- Wenden Sie sich an Ihren Medela Händler vor Ort, der Sie bei der Anwendung des Produkts berät.
- Bei allen Anwendungen Handschuhe tragen.

Diese Gebrauchsanweisung muss für den späteren Gebrauch aufbewahrt werden.

2 Stromversorgung und Akku-Betrieb

Die Clario Toni ist eine mit Netzstrom oder Akku betriebene Absaugpumpe. Bevor Sie das Gerät anschließen, kontrollieren Sie bitte, ob die auf dem Typenschild angegebene Spannung Ihrer hausinternen Spannung entspricht. Bei Betrieb gemäß dieser Gebrauchsanweisung hat das Clario Toni AC/DC-Modell eine maximale Akku-Betriebszeit von 50 Minuten, bis eine erneute Aufladung notwendig ist. Wenn das Clario Toni AC/DC-Modell nicht verwendet wird, muss der Akku alle 60–90 Tage kalibriert werden.

Akku fast leer

Während des Akku-Betriebs zeigt eine langsam blinkende LED an, dass der Akku bald entladen sein wird. Die Clario Toni bleibt für eine kurze Zeit (ca. 10 Minuten) weiter in Betrieb, aber der Akku sollte so bald wie möglich geladen werden.

Akku leer

Sobald der Akku leer ist, hält die Pumpe an. Die Funktionen der Pumpe stehen nicht mehr zur Verfügung. Der Akku muss geladen oder ausgetauscht werden.

3 Beschreibung

Einleitung

Die Clario Toni ist eine qualitativ hochwertige Absaugpumpe. Sie wird durch ein bewährtes Membran-System angetrieben. Das Gerät verbindet einfache Handhabung und Reinigung mit besonderen Sicherheitsmerkmalen, um einen optimalen Betrieb sicherzustellen. Verwendung nach Anweisung des Arztes und nur nach Einweisung in Bedienung und Gebrauch durch medizinisch geschulte Experten.

Bestimmungsgemäße Verwendung

Die Clario Toni Absaugpumpen sind zum Absaugen und Entfernen von Sekreten, Körperflüssigkeiten und Fremdkörpern aus den Atemwegen oder aus den nasalen, pharyngalen und trachealen Bereichen eines Patienten (Kinder und Erwachsene) geeignet. Diese Absaugpumpe ist geeignet für die Verwendung zu Hause, im Krankenhaus, im Auto oder im Freien.

Indikationen

Die Clario Toni Absaugpumpe ist dazu geeignet, die Atemwege durch die Nase, den Mund oder eine Tracheostomiekanüle von Sekreten zu befreien.

Kontraindikationen

Das Gerät ist nicht geeignet zum Dauerabsaugen.

Vorgesehene Benutzer

Die Clario Toni sollte nur von entsprechend angeleiteten Personen betrieben werden. Die Anwender dürfen nicht schwerhörig oder gehörlos sein und müssen über ein ausreichendes Sehvermögen verfügen. Die Anleitung muss mindestens einmal jährlich aufgefrischt werden.

Patientenzielgruppe

Die Clario Toni ist ausschließlich für den Einsatz an Patienten mit in den Anwendungshinweisen aufgeführten Beschwerden vorgesehen.

Wichtiger Hinweis

Die Befolgung ordnungsgemäßer chirurgischer Verfahrensweisen und Techniken liegt in der Verantwortung des Arztes. Jeder Arzt muss die jeweilige Angemessenheit des Verfahrens nach eigenem Wissen und eigener Erfahrung beurteilen.

4 Übersicht

Definition von Vakuum

In der Anwendung von medizinischen Absauggeräten wird Vakuum normalerweise als Differenz (in absoluten Zahlen) zwischen absolutem Druck und atmosphärischem Druck oder als negativer Wert in Kilopascal (kPa) angegeben. In diesem Dokument bedeutet z. B. die Angabe von -10kPa immer einen entsprechenden Druckbereich in kPa unter dem atmosphärischen Umgebungsdruck (nach EN ISO 10079:1999).

Versionen der Pumpe



Clario Toni AC/DC

Hauptbestandteile der Pumpe

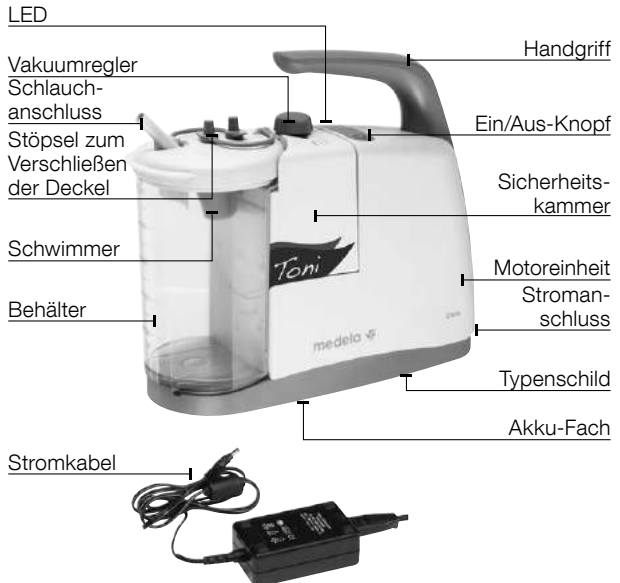

Position der Membran

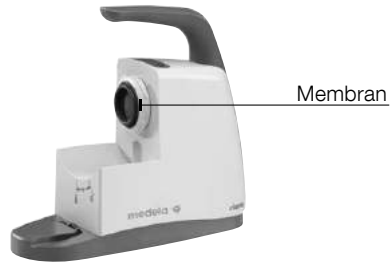

Ventilscheiben in der Sicherheitskammer

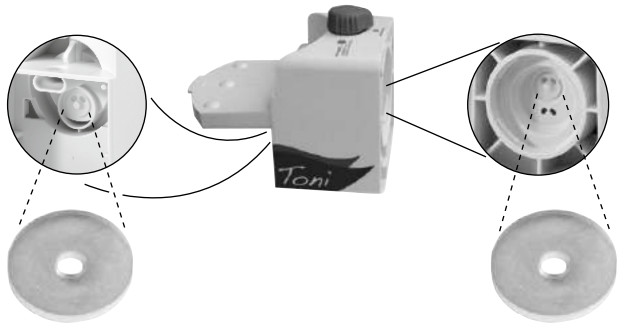

Bedienelemente und Ladezustand des Akkus



Vakuumregler

Ein/Aus-Knopf

Akku-LED

- leuchtet nicht** Akku vollständig geladen
- leuchtet ständig**
 - Akku wird geladen
 - Pumpe ist eingesteckt
- blinkt langsam** Akku ist fast leer
- blinkt schnell** Akku ist defekt

5 Installation

Lieferumfang überprüfen

Lieferumfang der Clario Toni auf Vollständigkeit und allgemeinen Zustand prüfen.



Clario Toni Versionen

REF	Clario Toni AC/DC	014.00XX
	Clario Toni Deluxe	014.00XX



Einweg-Schlauch mit Fingertip

REF	074.0003
------------	----------



Netzteil

REF	014.0004
------------	----------

Stromkabel

099.0011 (Euro)
014.0007 (UK)
014.0008 (AUS/NZ)
099.0014 (USA)



Gebrauchsanweisung

REF	200.8400
------------	----------



ACHTUNG

Der mit dem Gerät gelieferte Anschlusschlauch darf niemals mit dem Absaugbereich in direkten Kontakt kommen. Es muss immer ein steriler Saugkatheter verwendet werden (Infektionsrisiko).

6 Anwendung vorbereiten



ACHTUNG

Nur zur Anwendung durch medizinisch geschultes Personal, das in der Durchführung von Absaugtechniken und im Einsatz von Absauggeräten ausreichend geschult ist. Bei allen Anwendungen Handschuhe tragen.



VORSICHT

- Während des Gebrauchs muss die Clario Toni aufrecht stehen.
- Steriles Zubehör muss vor seiner Verwendung auf die Unversehrtheit der Verpackung geprüft werden.
- Nicht steriles und Mehrweg-Zubehör muss entsprechend den Medela Reinigungshinweisen (Art.-Nr. 200.2391) gereinigt, desinfiziert bzw. sterilisiert werden.

6.1 Tests vor Gebrauch

- **Überprüfen Sie das Clario Toni System vor Inbetriebnahme auf Beschädigungen des Stromkabels und Steckers, Schäden am Gerät, Sicherheitsdefekte und das korrekte Funktionieren des Geräts.**
- **Überprüfen Sie die Vollständigkeit und den Zustand des gelieferten Clario Toni Pakets.**
- **Stellen Sie sicher, dass der Akku gemäß Kapitel 12 kalibriert ist.**
- **Prüfen Sie sämtliches Zubehör vor Gebrauch:**
 - **Behälter und Deckel auf Risse, spröde und fehlerhafte Stellen untersuchen. Falls nötig ersetzen.**
 - **Schläuche auf Risse bzw. spröde Stellen untersuchen und sicherstellen, dass die Verbindungsstücke korrekt eingesteckt sind. Falls nötig ersetzen.**

6.2 Montage des Behälters

1.





1.1 Den Schwimmer am Behälter befestigen.

2.

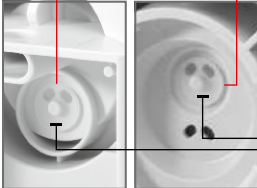

2.1 Den Deckel am Behälter befestigen. Markierungen von Behälter und Deckel beachten.

6.3 Montage der Sicherheitskammer

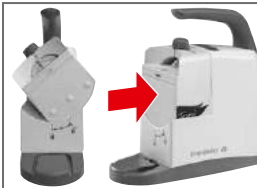
1.  1.1 Deckel der Sicherheitskammer öffnen.
2.  2.1 Sicherstellen, dass beide Ventile (Silikonscheiben) an der Sicherheitskammer angebracht sind. Siehe Kapitel 4.
3.  3.1 Deckel der Sicherheitskammer gut verschließen.
4.  4.1 Die Sicherheitskammer um 45° nach links neigen, um sie an der Motoreinheit zu befestigen.
4.2 Die Sicherheitskammer in aufrechte Stellung drehen, bis ein Klicken hörbar ist.

6.4 Behälter an der Pumpe anbringen

1.  1.1 Den Behälter an der Pumpe anbringen. Fest andrücken.
2.  2.1 Den Einweg-Fingertipschlauch am Schlauchanschluss anbringen.

7 Betriebsanweisungen



VORSICHT

Die Clario Toni muss so aufgestellt werden, dass sie auf einfache Weise vom Stromnetz getrennt werden kann. Der Akku ist vor dem ersten Einsatz zu kalibrieren.



ACHTUNG

Nur zur Anwendung durch medizinisch geschultes Personal, das in der Durchführung von Absaugtechniken und im Einsatz von Absauggeräten ausreichend geschult ist. Bei allen Anwendungen Handschuhe tragen.

7.1 Die Clario Toni mit dem Stromnetz verbinden

1. Überprüfen Sie die Pumpe vor dem Gebrauch entsprechend der Anleitung in Kapitel 6.1.

2. **Alle Versionen: Betrieb der Pumpe wenn sie mit dem Stromnetz verbunden ist:**

Den Netzstecker des Netzkabels in eine Steckdose einstecken.

oder

Wenn die Pumpe mit 12V Gleichstrom betrieben wird:

Das optionale 12V-Gleichstromkabel mit der Pumpe und einer 12V-Gleichstromquelle verbinden.

oder

Wenn die Pumpe mit einem Akku betrieben wird:

Keine Verbindung zu einer Stromquelle ist nötig. Sicherstellen, dass der Akku fünf Stunden lang geladen wurde.

7.2 Funktionstest mit Wasser

1.

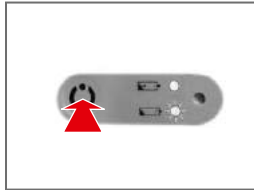

1.1 Ein/Aus-Knopf an der Pumpe drücken.

2.

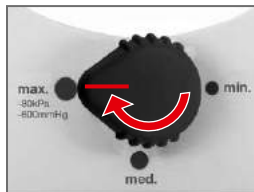

2.1 Vakuumpregler auf die Position „max.“ drehen.

3.

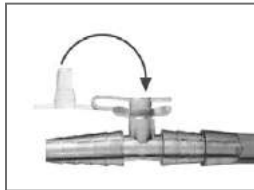

3.1 Fingertipschlauch befestigen. Siehe Kapitel 6.4, Schritt 2.1.

3.2 Fingertip-Anschluss mit Stöpsel verschließen.

4.

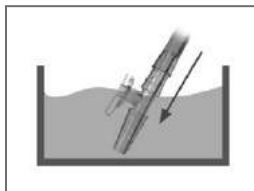

4.1 Fingertipstecker ins Wasser halten und kontrollieren, ob Sog vorhanden.

5. Wenn Sog vorhanden, weiter mit Schritt 6.
Wenn nicht, siehe Kapitel 13.

6. Vom Arzt vorgeschriebene Katheter und
Vakuumeinstellungen verwenden.

7.3 Alternative: Funktionstest mit dem optionalen Manometer



1.1 Befestigen Sie das optionale Manometer am Schlauchanschluss.



2.1 Ein/Aus-Knopf an der Pumpe drücken.

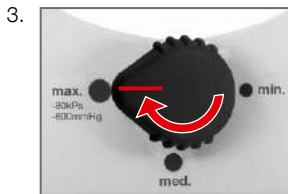

3.1 Vakuumregler auf die Position „max.“ drehen.

Höhe über Meeresspiegel:	Max. Vakuum:
+ 2000 m	- 63 kPa - 471 mmHg
+ 1000 m	- 71 kPa - 532 mmHg
+ 500 m	- 76 kPa - 566 mmHg
0 m	- 80 kPa - 600 mmHg

(Toleranz: - 15 %)



4.1 Das Vakuum mit den Zielwerten in der Tabelle (siehe links) vergleichen.

5. Wenn das Vakuum in Ordnung ist, weiter mit Schritt 6. Wenn nicht, siehe Kapitel 13.

6. Fingertipschlauch befestigen.

7. Vom Arzt vorgeschriebene Katheter und Vakuumeinstellungen verwenden.



ACHTUNG

Nur zur Anwendung durch medizinisch geschultes Personal, das in der Durchführung von Absaugtechniken und im Einsatz von Absauggeräten ausreichend geschult ist. Bei allen Anwendungen Handschuhe tragen.

7.4 Vakuumstärke ändern

1.

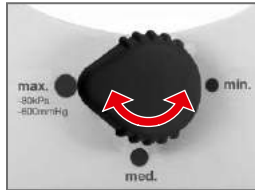

1.1 Vakuumregler auf benötigte Position drehen.

7.5 Außerbetriebnahme nach Gebrauch

1.

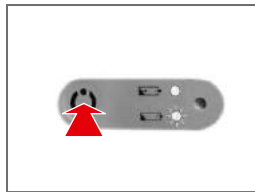

1.1 Ein/Aus-Knopf drücken, um die Pumpe auszuschalten.

2. **Wenn die Pumpe mit dem Stromnetz verbunden ist:**

Den Netzstecker aus der Steckdose ziehen.

oder

Wenn die Pumpe mit einer 12V-Gleichstromquelle verbunden ist:

Den 12V-Stecker aus der 12V-Stromquelle ziehen.



3. Die Clario Toni reinigen und desinfizieren. Siehe Kapitel 16.

8 Behälter leeren

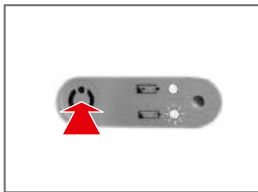

Sicherheitshinweis

Einmal täglich oder spätestens, wenn der Flüssigkeitsspiegel 550 ml erreicht und der Schwimmer das Absaugen unterbricht, sollte der Behälter geleert werden.

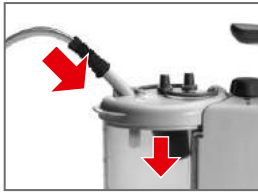
1.  1.1 Ein/Aus-Knopf drücken, um die Pumpe auszuschalten.
2.  2.1 Den Einweg-Fingertipschlauch vom Schlauchanschluss entfernen.
2.2 Den Behälter von der Pumpe entfernen.
3.  3.1 Den Behälter für den Transport immer mit den Stöpseln verschließen.
4. Behälter leeren und Fingertipschlauch entsorgen gemäß den lokalen und internen Vorschriften.
5.  5.1 Einen sauberen Behälter anbringen.
5.2 Einen neuen Einweg-Fingertipschlauch am Schlauchanschluss anbringen.
6. Pumpe einschalten und Vakuum entsprechend den Anweisungen des Arztes einstellen.

9 Ventilscheiben ersetzen

1.



1.1 Behälter entfernen.

2.

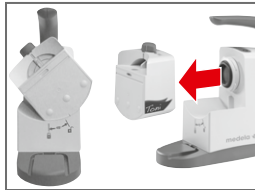

2.1 Sicherheitskammer 45° nach links drehen.

2.2 Sicherheitskammer von der Pumpe wegziehen.

3.



3.1 Sicherheitskammer öffnen.

4.

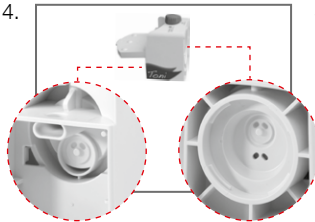

4.1 Defekte Ventilscheiben ersetzen. Sicherstellen, dass die neuen Ventilscheiben korrekt angebracht sind.

5. Sicherheitskammer an der Pumpe anbringen, wie in Kapitel 6.3 beschrieben.

10 Akku ersetzen



ACHTUNG

Vor dem Auswechseln des Akkus ist die Clario Toni abzuschalten und der Netzstecker aus der Steckdose zu ziehen.



Vor dem Austausch des Akkus Netzstecker aus der Steckdose ziehen.

1.

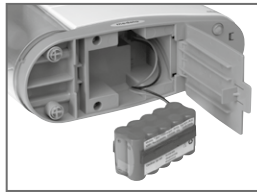

1.1 Klappe des Akku-Fachs auf der Unterseite der Clario Toni öffnen.

2.

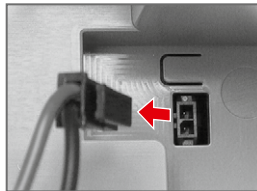

2.1 Stecker des Akku-Kabels aus der Dose ziehen.

3. Alten Akku entfernen.

4. Neuen Akku einsetzen.

5.

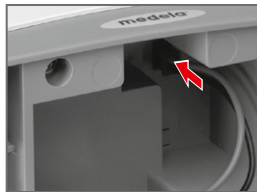

5.1 Das Akku-Kabel wieder einstecken.

6. Die Klappe des Akku-Fachs schließen. Sicherstellen, dass die Klappe gut geschlossen ist und das Kabel nicht eingeklemmt wurde.

7. Den Akku kalibrieren und testen (siehe Kapitel 11 und 12).

11 Akku-Daten und Test



VORSICHT

Den Akku der Clario Toni nur laden, wenn die Ladeanzeige langsam blinkt.

Dauer des Absaugens

Bei voller Akkuladung beträgt die Betriebsdauer bei maximaler Vakuumeistung etwas mehr als 50 Minuten.

Ladezeit (bis 100% Ladung)

Ca. 5 Stunden

Akku-Ladezustand

- leuchtet nicht** Akku ist vollständig geladen
- leuchtet ständig**
 - Akku wird geladen
 - Pumpe ist eingesteckt
- blinkt langsam** Akku ist fast leer
- blinkt schnell** Akku ist defekt

Akku testen

1. Sicherstellen, dass der Akku vollständig aufgeladen wurde.
2. Den Netzstecker aus der Steckdose ziehen.

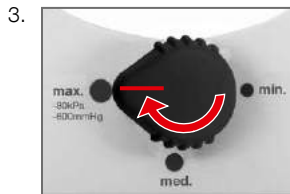

3.1 Vakuumpregler auf die Position „max.“ drehen.

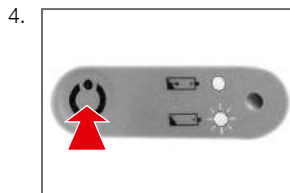

4.1 Die Clario Toni einschalten. Die Pumpe beginnt zu laufen.

5. Die Zeit messen, bis die Pumpe anhält. Der Akku ist in Ordnung, wenn die Betriebszeit über 50 Minuten beträgt.

Wenn die Betriebszeit weniger als 50 Minuten beträgt, den Test wiederholen oder den Akku kalibrieren (siehe nächste Seite).

12 Akku kalibrieren



VORSICHT

Der Akku ist vor dem ersten Einsatz und nach längerer Lagerung (über 2 Monate) zu kalibrieren. Falls die Kalibrierung nicht erfolgreich verläuft, muss der Akku ersetzt werden.

NiMH-Akku kalibrieren

1. Sicherstellen, dass der Akku vollständig aufgeladen wurde.
2. Den Netzstecker aus der Steckdose ziehen.

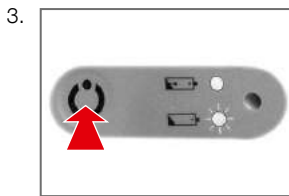

3.1 Die Clario Toni einschalten.
Die Pumpe beginnt zu laufen.

4. Die Pumpe laufen lassen, bis der Akku leer ist und die Pumpe anhält.
5. Die Clario Toni in die Steckdose einstecken.
Der Akku wird geladen.
6. Warten bis die Ladeanzeige erlischt.
7. Schritt 1 bis 6 wiederholen. Die Clario Toni AC/DC ist unbetriebsbereit.

Lagerung des Akkus

Um die Selbstentladung auf ein Minimum zu beschränken, sollten die Clario Toni und die entfernten Ersatzakkus bei einer Temperatur unter 25 °C (77 °F) gelagert werden. Wiederholen Sie die Kalibrierung alle 60–90 Tage.

13 Problembehebung

Motor läuft nicht

Prüfen Sie, ob:

- die Clario Toni eingeschaltet ist.
- die Netzspannung die richtige ist und ob der Netzstecker korrekt in der Steckdose eingesteckt ist.
- der Akku geladen ist.

Pumpe ist zu laut

Prüfen Sie die Position und die Abdichtung der Ventilscheiben in der Sicherheitskammer.

Ungenügendes Vakuum

Prüfen Sie, ob:

- der Vakuumregler richtig eingestellt ist.
- die Schläuche schadhaft oder undicht sind, falls nötig ersetzen.
- alle Steckverbindungen dicht sind.
- der Sekretbehälter und Deckel spröde Stellen, Risse oder Verfärbungen aufweisen, falls nötig ersetzen.
- die Ventilscheiben in der Sicherheitskammer gut abdichten.
- die Membran sauber ist und keine Risse hat.

Ungenügende Laufzeit des Akkus

Den Akku kalibrieren. Siehe Kapitel 12.

LED leuchtet nicht

Der Akku ist vollständig geladen.

LED leuchtet

- Der Akku wird geladen.
- Die Pumpe ist eingesteckt.

LED blinkt langsam

Akku ist bald leer. Die Akkuleistung reicht noch für rund 10 Minuten Pumpzeit.

LED blinkt schnell

Akku ist defekt. Um den Akku zu ersetzen, siehe Kapitel 10.

14 Garantie und Wartung

Garantie

Medela AG gewährleistet für einen Zeitraum von 2 Jahren (6 Monaten für den Akku) ab Lieferdatum, dass das Gerät frei von Material- und Verarbeitungsmängeln ist. Fehlerhaftes Material wird während dieses Zeitraums kostenlos ersetzt, außer diese Fehler sind auf Missbrauch oder unsachgemäße Anwendung zurückzuführen. Die Gewährleistung gilt nicht für Teile, die im Gebrauch Verschleiß unterworfen sind. Um die Bedingungen dieser Gewährleistung zu erfüllen und mit den Medela Produkten die besten Leistungen zu erzielen, empfehlen wir, mit unseren Geräten ausschließlich Medela Zubehör zu verwenden.

Medela AG übernimmt keinerlei Haftung für Forderungen, die den beschriebenen Rahmen der Gewährleistung überschreiten, einschließlich der Haftung für Folgeschäden usw. Das Anrecht auf Ersatz von fehlerhaften Teilen wird von Medela nicht anerkannt, falls unberechtigte Personen Arbeiten an der Pumpe vorgenommen haben. Diese Gewährleistung gilt unter der Voraussetzung, dass das Gerät in ein Medela Servicezentrum eingeschickt wird.

Wartung

Servicearbeiten sind nur durch die von Medela autorisierten Stellen auszuführen. Die Service Anleitung von Medela ist auf Anfrage erhältlich.

15 Entsorgung

Die Clario Toni besteht aus Metallen und Kunststoffen und ist gemäß den europäischen Richtlinien 2011/65/EG und 2012/19/EG zu entsorgen. Des Weiteren sind die örtlichen Richtlinien zu beachten. Bei der AC/DC-Version sind die elektronischen Komponenten und der Akku separat, gemäß den örtlichen Richtlinien zu entsorgen.

Bitte beachten Sie die örtlichen Entsorgungsvorschriften, wenn Sie die Clario Toni und ihr Zubehör entsorgen.



Benutzerinformation zur Entsorgung von elektrischen und elektronischen Geräten

Dieses Symbol bedeutet, dass das elektrische oder elektronische Gerät nicht im normalen Hausmüll entsorgt werden darf. Die richtige Entsorgung dieses Geräts schützt die Umwelt und verhindert mögliche Schäden an Menschen und Umwelt.

Für weitere Informationen zur Entsorgung wenden Sie sich bitte an den Hersteller oder Ihr Pflegepersonal. Dieses Symbol ist nur in der Europäischen Union gültig. Bitte befolgen Sie die in Ihrem Land geltenden Gesetze und Verordnungen bezüglich der Entsorgung von elektrischen und elektronischen Geräten.

16 Richtlinien für die Reinigung



ACHTUNG

Nach jedem Gebrauch sind die Teile, die mit angesaugten Sekreten in Kontakt gekommen sind, **entsprechend der Tabelle auf der nächsten Seite** zu reinigen, desinfizieren, sterilisieren oder zu entsorgen.



Vor der Reinigung des Geräts ist der Netzstecker aus der Steckdose zu ziehen.

Allgemeine Hinweise

- Diese Empfehlungen sind allgemeiner Natur und können von Fall zu Fall, entsprechend den Richtlinien und Reinigungspraktiken des Krankenhauses, angepasst werden.
- Detaillierte Informationen sind in den Medela Reinigungshinweisen (Art.-Nr. 200.2391) zu finden.
- Für die Reinigung/Desinfektion geeignete Schutzhandschuhe tragen.
- Flüssigkeiten wie Blut und Sekrete und damit kontaminierte Teile gemäß den krankenhausernen Richtlinien entsorgen.

Medela empfiehlt folgende Oberflächenreiniger für das Pumpengehäuse

- **CaviWipes**, Metrex Research, www.sybrondental.com
- **mikrozid® AF wipes**, Schülke&Mayr GmbH, www.schuelke.com

Wasser

Benutzen Sie nur Wasser der reinsten Qualität für die Reinigung. Die Wasserhärte stellt ein ernstes Problem dar, da Rückstände auf medizinischen Produkten eine wirksame Reinigung beeinträchtigen können. Verwenden Sie entionisiertes Wasser, um dieses Problem zu vermeiden. Das letzte Spülwasser sollte bakteriell rein und frei von Endotoxinen sein.

Reinigungs-/Desinfektionsgeräte

Solche Geräte können für das Desinfizieren von Teilen gemäß der Tabelle auf der folgenden Seite verwendet werden. Durch eine Heißwasserspülung (maximale Temperatur 100 °C) kann ein mittleres bis hohes Desinfektionsniveau erzielt werden. Die Bestandteile müssen überall zugänglich sein, um eine wirksame Reinigung zu gewährleisten. Wir empfehlen, ein Reinigungs- bzw. Desinfektionsgerät zu verwenden, das vom Robert-Koch-Institut abgenommen wurde und der Norm ISO 15883 entspricht. Die empfohlene Temperatur für unkritische medizinische Geräte (d. h. die nur mit unverletzter Haut in Kontakt kommen) ist 90 °C während 1 Minute. Für alle Geräte, die als kritisch eingeschätzt werden, beträgt die Zeit 5 Minuten.



Einweg-Artikel

Dies sind Einweg-Produkte, die nicht für die Wiederverwendung vorgesehen sind. Eine erneute Verwendung könnte zum Verlust der mechanischen, chemischen und/oder biologischen Eigenschaften führen. Wiederverwendung kann zu einer Kreuzkontamination führen.

Behälter, Sicherheitskammer	Pumpengehäuse, Stromkabel	
x	x	<p>1. Demontage Gerät vor dem Reinigen, Desinfizieren und Sterilisieren in seine Bestandteile zerlegen.</p>
x		<p>2. Reinigung des Behälters und der Sicherheitskammer Ein Reinigungsmittel in heißes Wasser (60–70 °C) geben und Einzelteile darin reinigen. Der pH-Wert des Reinigungsmittels muss zwischen 6,0 und 8,0 liegen, um Schäden an Instrumenten und Reinigungsbehälter zu vermeiden. Enzymreiniger erleichtern das Entfernen von organischen Stoffen wie Blut. Reinigungsmittel sollten in den Konzentrationen verwendet werden, die der Hersteller empfiehlt. Einige alkalische Reinigungsmittel sind so zusammengesetzt, dass sie sich für die Wiederaufbereitung von medizinischen Geräten eignen. Die Hersteller dieser Reinigungsmittel sollten Informationen darüber bereitstellen, welche Materialien durch ihre Reinigungsmittel beschädigt werden könnten. Alle Einzelteile in warmem Seifenwasser oder in Enzymreiniger für 1–5 Minuten gründlich einweichen lassen. 1. Sichtbare Verschmutzung mit einem Reinigungswerkzeug entfernen; geeignet sind normale Reinigungsbürsten, Rohrputzer oder nichtscheuernde, fusselfreie Tücher. Bürsten und Rohrputzer sollten passgenau gewählt werden, sodass sie eng anliegen, jedoch leicht im zu reinigenden Bereich hin- und herbewegt werden können. Gründlich mit sauberem Wasser abspülen. Trocknen lassen. 2. Überprüfen Sie die Teile auf sichtbaren Schmutz und wiederholen Sie diese Schritte falls nötig.</p>
	x	<p>3. Reinigung des Pumpengehäuses und des Stromkabels Mit dem oben erwähnten Reinigungsmittel abwischen. Tuch ausspülen und Teile nachwischen.</p>
x		<p>4. Desinfektion Bei Raumtemperatur während 30 Minuten in einer Desinfektions-/Reinigungslösung (A) einweichen lassen. Nach dieser Reaktionszeit die Lösungsrückstände von den Einzelteilen abspülen und die Schläuche durchspülen. Mindestens 2 Minuten lang mit der Reinigungslösung (B) spülen.</p> <p>(A) Flüssiges aldehydfreies Desinfektionsmittel mit Reinigungswirkung zur Verwendung als Tauchbad, Bakterizid, Fungizid und begrenzt als Viruzid, mit sehr guter Materialverträglichkeit gegenüber Edelstahl, Buntmetallen und Kunststoffen einschließlich Silikon, schwach alkalisch. Zum Beispiel 2 % neodisher® Septo MED-Lösung.</p> <p>(B) Flüssiges, pH-neutrales, enzymhaltiges Reinigungsmittel zur maschinellen und manuellen Instrumentenaufbereitung mit sehr guter Materialverträglichkeit gegenüber Edelstahl, Buntmetallen und Kunststoffen einschließlich Silikon.</p> <p>oder benutzen Sie ein Reinigungs-/Desinfektionsgerät oder eine Geschirrspülmaschine.</p>
x		<p>5. Lagerung der Einzelteile Die Komponenten nach der Desinfektion auf einem sauberen und trockenen Tuch lagern.</p>

17 Zubehörübersicht



ACHTUNG

Die Clario Toni wurde in Kombination mit dem im Folgenden aufgeführten Zubehör getestet. Für einen korrekten und sicheren Betrieb sollten Sie die Clario Toni ausschließlich mit diesem Zubehör verwenden. Weitere Informationen sind den Anleitungen der jeweiligen Zubehörteile zu entnehmen.

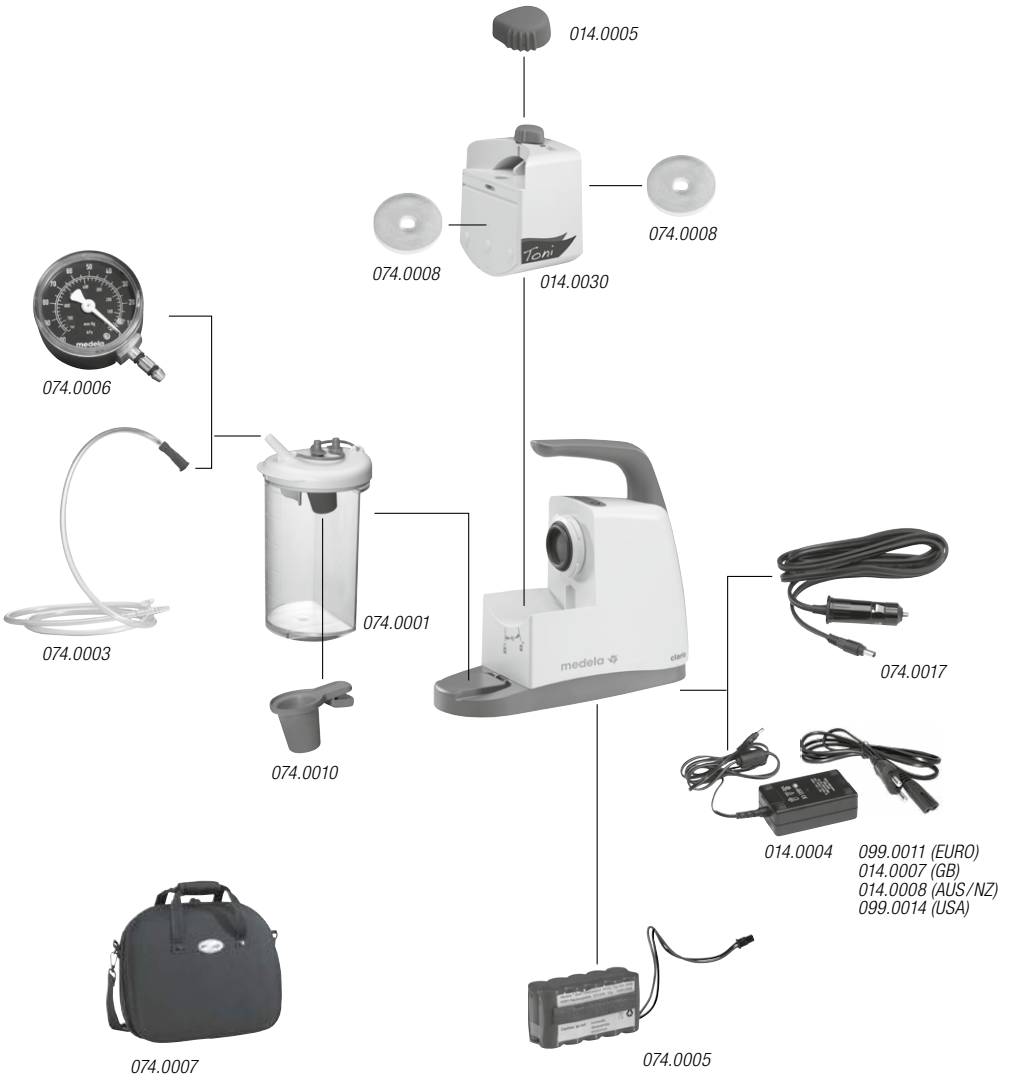

18 Zubehörliste



Sicherheitshinweis

Wenn die Pumpe zusammen mit Anwendungsteilen verwendet wird, die nicht von Medela stammen, müssen diese:

- das CE-Kennzeichen tragen und (falls nötig) am Verwendungsort registriert sein
- dafür geeignet sein, sicher an Medela Zubehör angeschlossen zu werden, ohne die Leistung der Pumpe zu beeinträchtigen.

Hinweis: Wenn Sie Medela-Teile und Nicht-Medela-Teile miteinander kombinieren, übernehmen Sie die Verantwortung für das gesamte System.

REF

- 014.0030 Sicherheitskammer
- 014.0005 Vakuumregler
- 074.0008 Ventilscheiben (10 Stück)
- 074.0001 Behälterset
- 074.0010 Schwimmer (10 Stück)
- 074.0003 Einweg-Schlauch mit Fingertip
- 074.0005 Wiederaufladbarer Akku
- 014.0004 Netzteil
- 099.0011 Netzkabel (EURO)
- 099.0014 Netzkabel (USA)
- 014.0007 Netzkabel (GB)
- 074.0007 Tragetasche
- 074.0017 Auto-Anschlusskabel für 12V DC
- 074.0006 Manometer

19 Zeichen und Symbole



Dieses Symbol zeigt die Übereinstimmung mit wesentlichen Anforderungen der Richtlinie 93/42/EWG des Rates vom 14. Juni 1993 über Medizinprodukte an.



Dieses Symbol zeigt einen Sicherheitshinweis an.



Dieses Symbol zeigt das Herstellungsdatum (vier Ziffern für das Jahr und zwei Ziffern für den Monat) an.



Dieses Symbol zeigt die Klasse der Pumpe an.



Dieses Symbol zeigt an, dass das Gerät nicht nach Ende des angegebenen Jahres und Monats verwendet werden sollte.



Dieses Symbol zeigt ein Gerät der Klasse II an.



Dieses Symbol zeigt ein Einweggerät an. Nicht wiederverwenden.



Dieses Symbol zeigt die Übereinstimmung mit zusätzlichen US-amerikanischen und kanadischen Sicherheitsvorschriften für medizinische und elektrische Geräte an.

IP21

Dieses Symbol zeigt den Schutz gegen das Eindringen von Fremdkörpern und gegen schädliche Auswirkungen infolge des Eindringens von Wasser an.



Dieses Symbol zeigt die Katalognummer des Herstellers an.



Dieses Symbol zeigt die gesetzlichen Vorgaben der Pumpe an.



Dieses Symbol zeigt einen Anwendungsteil vom Typ BF an.



Dieses Symbol zeigt die Seriennummer des Herstellers an.



Dieses Symbol zeigt an, dass die Gebrauchsanweisung zu befolgen ist.



Dieses Symbol zeigt an, dass das Gerät für Magnetresonanz (MR) nicht geeignet ist.



Dieses Symbol zeigt die Chargennummer des Herstellers an.



Dieses Symbol zeigt an, dass in der Gebrauchsanweisung nachzuschlagen ist.



Dieses Symbol zeigt an, dass in der Umgebung von Geräten mit diesem Symbol Interferenzen möglich sind.



Dieses Symbol zeigt an, dass das Gerät mit Ethylenoxid sterilisiert wurde.



Dieses Symbol zeigt einen Hinweis (VORSICHT oder ACHTUNG) zum Gerät an.



Dieses Symbol zeigt den Hersteller an.





Dieses Symbol zeigt die Temperaturbeschränkung für Betrieb, Transport und Lagerung an.



Dieses Symbol zeigt die Feuchtebegrenzung für Betrieb, Transport und Lagerung an.

 Dieses Symbol zeigt die Begrenzung des atmosphärischen Drucks für Betrieb, Transport und Lagerung an.

 Dieses Symbol zeigt an, dass das Gerät nicht verwendet werden darf, falls die Packung beschädigt ist.

 Dieses Symbol zeigt an, für wie viele Artikel „n“ der Inhalt ausreicht.

 Dieses Symbol zeigt an, dass das Gerät nicht zusammen mit unsortierten Siedlungsabfällen entsorgt werden darf (gilt nur in der EU).

 Dieses Symbol zeigt an, dass das Material der Rückgewinnung von Ressourcen/dem Recycling zugeführt wird.

 Dieses Symbol bedeutet Kartonverpackung.

 Dieses Symbol zeigt an, dass das Gerät vor Sonnenlicht zu schützen ist.

 Dieses Symbol zeigt an, dass das zerbrechliche Gerät mit Vorsicht zu behandeln ist.

 Dieses Symbol zeigt an, dass das Gerät trocken zu halten ist.

 Dieses Symbol zeigt die höchste Vakuumstufe der Pumpe an.

 Dieses Symbol zeigt die Durchflussmenge der Pumpe an.

 Dieses Symbol zeigt die elektrische Spezifikation der Pumpe an.

 Dieses Symbol zeigt Wechselstrom an.

 Dieses Symbol zeigt Gleichstrom an.

 Dieses Symbol zeigt das Gewicht der Pumpe an.

 Dieses Symbol zeigt die Abmessungen (H x B x T) der Pumpe an.

R_{only} Dieses Symbol zeigt ein rezeptpflichtiges Gerät an.
VORSICHT: Nach US-Bundesgesetz darf dieses Gerät nur von Ärzten oder auf deren Anweisung verkauft werden (gilt nur für die USA).

pcs Dieses Symbol zeigt die Stückzahl an.

20 Technische Daten



min. Vakuum, - 70 mmHg / - 9 kPa (+/- 20 mmHg / +/- 2.6 kPa)
mittl. Vakuum, - 115 mmHg / - 15 kPa (+/- 30 mmHg / +/- 4 kPa)
max. Vakuum, - 600 mmHg / - 80 kPa (- 90 mmHg / - 12 kPa)

Berechnet bei 0 m, atmosphärischer Druck: 1013 hPa
Bitte beachten: Vakuumstärke kann je nach Lage
(Meter über Meeresspiegel, atmosphärischer Druck
und Temperatur) variieren.



Geringer Durchfluss: 15 l/Min. (+/- 10%)



2,0 kg / 4,4 lbs
Ohne Behälter



100-240 V, 50-60 Hz
12 V, 3,4A, NiMH
Netzteil
UE48-120340SPA1



ISO 13485
93/42 EWG Klasse IIa



HxBxT
223x255x95 mm

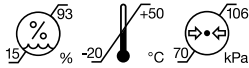

Transport/Lagerungsbedingungen



Transport/Lagerung
Wiederaufladbarer Akku

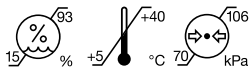

Betriebsbedingungen



IP21

21 Technische Dokumentation



ACHTUNG

Benutzen Sie keine Ersatzteile, die nicht vom Hersteller freigegeben oder von ihm als Ersatzteile für interne Komponenten verkauft werden, da dies zu stärkeren Emissionen oder erhöhter Störanfälligkeit der Clario Toni Pumpe führen könnte.

Hochfrequenz-Operationsgeräte (HF), Funknetze o. Ä. können den Betrieb des Geräts beeinträchtigen und sollten nicht in Kombination mit der Clario Toni betrieben werden.

EMV

Clario Toni ist entsprechend den Anforderungen von IEC 60601-1-2:2007 und IEC 60601-1-2:2014 4. Fassung gemäß Abschnitt 7 und 8.9 EMV-geprüft. Die Clario Toni ist ein medizinisches Gerät, welches spezielle Sicherheitsmaßnahmen betreffend EMV bedingt und gemäß den beiliegenden EMV-Informationen installiert und in Betrieb genommen werden muss.

Siehe auch Seiten 326–329.

Table des matières

Félicitations	68
1 Instructions de sécurité	69
Consignes de sécurité.....	71
2 Alimentation électrique et fonctionnement sur batterie	72
Batterie faible.....	72
Batterie vide.....	72
3 Description	73
Introduction	73
Usage prévu/indications.....	73
Contre-indications	73
Utilisateur.....	73
Patients ciblés	73
Remarque importante.....	73
4 Aperçu	74
Définition du vide.....	74
Versions de l'aspirateur	74
Principaux éléments de l'aspirateur.....	74
Position de la membrane.....	75
Membrane dans la chambre de sécurité.....	75
Éléments et état de charge de la batterie.....	75
5 Installation	76
Contrôler l'appareil dès livraison.....	76
6 Préparation pour l'utilisation	77
Vérifications avant l'utilisation	77
Assemblage du bocal.....	77
Assemblage de la chambre de sécurité	78
Fixation du bocal à l'aspirateur	78
7 Mode d'emploi	79
Brancher Clario Toni au secteur	79
Contrôle des fonctions avec de l'eau.....	80
Autre possibilité : contrôle des fonctions avec le manomètre en option	81
Modifier le niveau de vide.....	82
Mise hors tension après usage.....	82
8 Vider le bocal	83
9 Remplacer les membranes	84

10	Changement de la batterie	85
11	Informations de la batterie et test	86
	Durée de l'aspiration.....	86
	Durée de charge (jusqu'à 100 %)	86
	État de la batterie	86
	Test de la batterie.....	86
12	Calibrage de la batterie	87
	Calibrage de la batterie NiMH	87
	Entreposage de la batterie	87
13	Pannes et solutions	88
	Le moteur ne fonctionne pas.....	88
	La pompe est trop bruyante.....	88
	Vide insuffisant	88
	Autonomie de la batterie insuffisante	88
	Le voyant LED est éteint.....	88
	Le voyant LED est allumé	88
	Le voyant LED clignote lentement	88
	Le voyant LED clignote rapidement.....	88
14	Garantie et maintenance	89
	Garantie.....	89
	Maintenance.....	89
15	Élimination	89
16	Consignes de nettoyage	90
	Remarques générales.....	90
	Produits nettoyants de surface recommandés par Medela pour le boîtier de l'aspirateur ...	90
	Eau	90
	Machines de nettoyage/désinfection	90
	Produits à usage unique.....	90
17	Vue d'ensemble des accessoires	92
18	Légende des accessoires	93
19	Signes et symboles	94
20	Spécifications techniques	96
21	Documentation technique	97
	Documentation technique/EMC.....	326

Félicitations

En choisissant le Clario Toni, vous avez opté pour un aspirateur de haute qualité qui s'adapte à vos besoins, exclusivement sur ordonnance d'un médecin/professionnel de la santé. Ce produit vous garantit avec un système unique d'hygiène à trois niveaux une protection optimale contre tout débordement. Ceci est assuré par un système à membrane avec un moteur électrique.

Utilisant trois positions de vide, la force d'aspiration peut être ajustée au niveau souhaitée.

Comme tous les aspirateurs Medela, ce modèle assure une aspiration fiable et simple. De plus, il est facile à utiliser et à nettoyer et offre des avantages en matière de sécurité. N'hésitez pas à nous contacter, nous nous ferons un plaisir de vous renseigner.

1 Instructions de sécurité



AVERTISSEMENTS

Indique une situation potentiellement dangereuse qui, si elle n'est pas évitée, peut entraîner la mort ou de graves blessures.



ATTENTION

Indique une situation potentiellement dangereuse qui, si elle n'est pas évitée, pourrait entraîner une blessure légère ou modérée.



Conseils de sécurité

Indique une information utile sur l'utilisation de l'appareil en toute sécurité.

Le Clario Toni est exclusivement indiqué pour l'utilisation décrite dans ce mode d'emploi. Medela ne peut garantir la sécurité de fonctionnement du système que si le Clario Toni est utilisé en association avec les accessoires originaux de Medela. Voir chapitres 17/18.

Veillez lire et respecter les mises en garde et consignes de sécurité avant toute utilisation. Ce mode d'emploi doit être conservé avec l'appareil pour les utilisations futures.

Ce mode d'emploi sert de directive générale pour l'utilisation du produit. Les questions médicales doivent être traitées par un médecin.

Medela n'assume la responsabilité des effets du Clario Toni sur la SÉCURITÉ DE BASE et n'assure la fiabilité et les performances de l'appareil qu'à partir du moment où celui-ci est utilisé conformément au mode d'emploi.

ATTENTION : La loi fédérale américaine limite la vente de ce dispositif à un médecin ou sur ordonnance d'un médecin.

Sous réserve de modifications.



AVERTISSEMENTS

- Le dispositif ne doit être utilisé que par du personnel spécialement formé aux méthodes d'aspiration et dans l'utilisation d'aspirateurs médicaux.
- Pour les patients chez lesquels un arrêt de l'aspirateur pourrait entraîner une situation critique, (p. ex. patients avec détresse respiratoire aiguë ou forte production de mucus), il est nécessaire de disposer d'un appareil supplémentaire.
- Le dispositif ne doit pas être utilisé pour l'aspiration de liquides explosifs, inflammables ou corrosifs.
- La tubulure de raccordement fournie avec le dispositif ne doit jamais entrer en contact direct avec la zone d'aspiration. Toujours utiliser une sonde d'aspiration stérile (risque d'infection).
- Avant le nettoyage, débrancher le dispositif du secteur fixe.
- Toute modification de cet équipement est interdite.
- Ne pas connecter l'appareil avec un drain fonctionnant par gravité (type valve de Heimlich)
- Veuillez consulter les indications, les facteurs de risque ainsi que les contre-indications avant d'utiliser le Clario Toni. Le non-respect peut entraîner des dangers considérables pour le patient.
- Ne pas utiliser Clario Toni dans une zone d'IRM (imagerie par résonance magnétique).
- Il peut arriver qu'une décharge électrostatique (ESD) au port CC de 15 kV endommage l'alimentation électrique.



ATTENTION

- Un usage inapproprié peut engendrer des douleurs ou blesser le patient.
- Ne pas utiliser d'accessoires stériles dont l'emballage a été endommagé.
- Les dispositifs de communication sans fil tels que les dispositifs domestiques sans fil en réseau, les téléphones portables, les téléphones sans fil et leurs bases, les talkies-walkies peuvent perturber le dispositif médical Clario Toni et doivent se trouver à au moins 30 cm de l'appareil.
- Les dispositifs médicaux peuvent être influencés par des appareils de communication RF portables et mobiles.



Conseils de sécurité

- Pour les tests de sécurité, le dispositif est présumé être entretenu et réparé conformément aux instructions d'entretien tout au long de sa durée de vie. Le Clario Toni étant un appareil de classe de protection IIa (EN IEC 60601-1, A1, A2:1995), les tests de sécurité sont limités à une inspection visuelle du boîtier et du cordon d'alimentation. Ce test doit être réalisé avant chaque utilisation.
- Tester la fuite du patient : se reporter au manuel d'entretien pour plus de détails.
- La protection du Clario Toni contre les effets de l'utilisation d'un défibrillateur cardiaque dépend de l'utilisation de câbles appropriés.
- La déconnexion du réseau électrique s'effectue en débranchant le connecteur et la prise secteur fixe.
- Avant de brancher le dispositif, veuillez vérifier que la tension locale correspond à celle indiquée sur la plaque de spécification.

Consignes de sécurité

- Le Clario Toni de Medela est un appareil médical qui impose des mesures de sécurité particulières concernant la CEM. Il doit être installé et utilisé conformément à l'information CEM ci-jointe.
- L'appareil ne doit pas être utilisé et doit être réparé par le service après-vente compétent dans les cas suivants :
 - lorsque le câble d'alimentation ou la prise électrique sont endommagés
 - lorsque le dispositif ne fonctionne pas correctement
 - lorsque le dispositif est endommagé
 - lorsque le dispositif présente des défauts de sécurité évidents.
- Éloigner le cordon d'alimentation des surfaces chaudes.
- Éloigner la prise secteur et l'interrupteur Marche/Arrêt de l'humidité.
- Ne jamais débrancher le connecteur de la prise de courant en tirant sur le câble d'alimentation !
- Ne jamais laisser le dispositif sans surveillance quand il est mis en marche.
- Pendant son utilisation, l'aspirateur doit être en position verticale.
- Ne jamais placer le cordon d'alimentation autour de votre cou.
- Ne jamais faire fonctionner l'appareil dans des pièces à températures élevées, pendant le bain ou sous la douche, en cas de grande fatigue ou dans un environnement comportant des risques d'explosion.
- Ne jamais placer l'appareil dans l'eau ou d'autres liquides.
- Lors de l'utilisation de produits stériles à usage unique, veuillez noter que ceux-ci ne sont pas destinés à être retraités. Tout retraitement est susceptible d'entraîner la perte des propriétés mécaniques, chimiques et/ou biologiques. Toute réutilisation pourrait entraîner une contamination croisée.
- Si vous avez besoin d'aide concernant l'utilisation de ce produit, contactez votre représentant local Medela.
- Porter des gants lors de chaque utilisation.

Conserver ce mode d'emploi pour une utilisation ultérieure.

2 Alimentation électrique et fonctionnement sur batterie

Le Clario Toni est un aspirateur à brancher sur le secteur ou fonctionnant sur batterie. Avant de brancher le dispositif, veuillez vérifier que la tension locale correspond à celle indiquée sur la plaque de spécification. Utilisé conformément aux instructions contenues dans ce manuel de l'utilisateur, le modèle CA/CC Clario Toni dispose d'une durée de batterie de 50 minutes maximum avant qu'il ne soit nécessaire de recharger. Si le modèle CA/CC Clario Toni n'est pas utilisé, la batterie doit être calibrée tous les 60–90 jours.

Batterie faible

Au cours d'un fonctionnement sur batterie, un clignotement lent du voyant LED indique que la batterie sera bientôt déchargée. Le fonctionnement du Clario Toni est maintenu peu de temps (~10 minutes), mais la batterie doit être rechargée aussitôt que possible.

Batterie vide

Dès que la batterie est vide, l'aspirateur s'arrête. Le bon fonctionnement de l'appareil n'est plus assuré. La batterie doit être rechargée ou remplacée.

3 Description

Introduction

Le Clario Toni est un aspirateur de grande qualité. Il fonctionne grâce au système à membrane éprouvé. Sa facilité d'utilisation et de nettoyage est associée à des caractéristiques de sécurité pour assurer un fonctionnement optimal. Utiliser d'après les instructions de votre médecin, et après avoir reçu les instructions de spécialistes expérimentés.

Usage prévu

Les aspirateurs médicaux Clario Toni sont recommandés pour l'aspiration et l'élimination de sécrétions, fluides corporels et corps étrangers situés dans les cavités nasales, pharyngées et trachéales chez l'enfant et l'adulte. Cet aspirateur médical convient pour un usage à domicile, à l'hôpital, en voiture ou hors de chez soi.

Indications

L'aspirateur médical Clario Toni est indiqué pour dégager les voies ORL.

Contre-indications

Cet appareil ne convient pas pour une aspiration prolongée.

Utilisateur

L'utilisation du Clario Toni devrait exclusivement être réservée à des personnes ayant reçu des instructions appropriées. Celles-ci ne doivent pas être mal-entendantes ou sourdes et doivent avoir une acuité visuelle normale. Une nouvelle formation doit être assurée au moins une fois par an.

Patients ciblés

Le Clario Toni est uniquement destiné à être utilisé sur des patients présentant les affections décrites dans le mode d'emploi.

Remarque importante

C'est le médecin qui est responsable de l'observation des techniques et méthodes chirurgicales adéquates. Chaque médecin doit évaluer si le traitement est indiqué, en se basant sur ses connaissances et son expérience.

4 Aperçu

Définition du vide

En cas d'application de systèmes médicaux d'aspiration, l'indication du vide se fait normalement sous forme de différence (en chiffres absolus) entre la pression absolue et la pression atmosphérique ou, comme valeurs négatives, en kilopascal (kPa). Dans ce document, l'indication -10 kPa, par ex., fait toujours référence à une plage de pression en kPa au-dessous de la pression atmosphérique ambiante (selon la norme EN ISO 10079:1999).

Versions de l'aspirateur



Clario Toni CA/CC

Principaux éléments de l'aspirateur

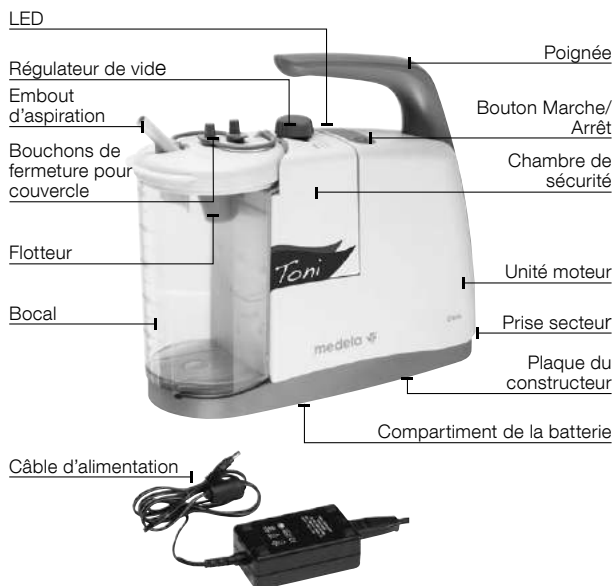

Position de la membrane

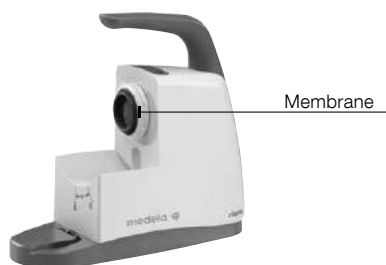

Membrane dans la chambre de sécurité

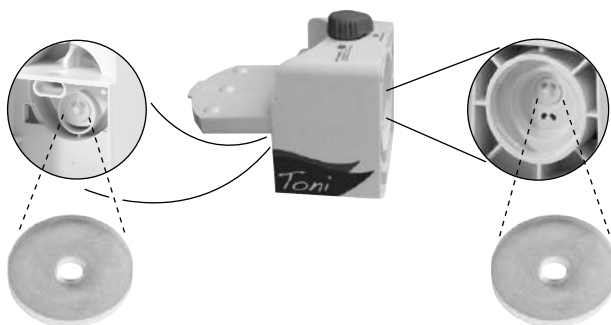

Éléments et état de charge de la batterie

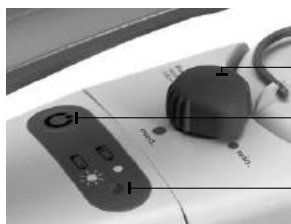

Régulateur de vide

Bouton Marche/Arrêt

Batterie LED

éteint Batterie pleine

allumé – La batterie est alors en charge
– L'aspirateur est branché

clignote lentement La batterie est bientôt vide
clignote rapidement La batterie est défectueuse

5 Installation

Contrôler l'appareil dès livraison

Vérifier que le contenu du paquet du Clario Toni est complet et qu'il est en bon état.



Versions du Clario Toni

REF	Clario Toni CA/CC	014.00XX
	Clario Toni Deluxe	014.00XX



Tuyau à usage unique avec réglage au doigt

REF	074.0003
------------	----------



Adaptateur secteur

REF	014.0004
------------	----------

Câble d'alimentation

099.0011 (Euro)
014.0007 (UK)
014.0008 (AUS/NZ)
099.0014 (USA)



Mode d'emploi

REF	200.8400
------------	----------



AVERTISSEMENTS

Le tuyau de raccordement fourni avec le dispositif ne doit jamais entrer en contact direct avec la zone d'aspiration. Un drain d'aspiration stérile doit toujours être utilisé (risque d'infection).

6 Préparation pour l'utilisation



AVERTISSEMENTS

Le dispositif ne doit être utilisé que par du personnel spécialement formé aux méthodes d'aspiration et dans l'utilisation d'aspirateurs médicaux. Porter des gants lors de chaque utilisation.



ATTENTION

- Pendant son utilisation, le Clario Toni doit être en position verticale.
- L'intégrité de l'emballage des accessoires stériles doit être contrôlée avant leur utilisation.
- Les accessoires non stériles et réutilisables doivent être nettoyés, désinfectés et/ou stérilisés selon le guide de nettoyage de Medela (code produit 200.2391).

6.1 Vérifications avant l'utilisation

- Avant d'utiliser le Clario Toni, vérifier que le cordon d'alimentation et la prise n'ont pas été endommagés, qu'il n'y a aucun dommage ou défaut de sécurité évident et que le dispositif est en bon état de marche.
- Vérifier que le contenu de l'emballage du Clario Toni est complet et qu'il est en bon état général.
- Assurez-vous que la batterie est calibrée conformément au chapitre 12.
- Vérifier tous les accessoires avant leur utilisation :
 - S'assurer que le bocal et le couvercle ne présentent aucune fissure, craquelure ou défaut. Remplacer si nécessaire.
 - S'assurer que les tuyaux ne présentent aucune fissure ou craquelure et que les connecteurs sont fermement attachés. Remplacer si nécessaire.

6.2 Assemblage du bocal

1.



1.1 Fixer le clapet anti-débordement au bocal.

2.



2.1 Fixer le couvercle au bocal. Faire attention aux repères sur le devant du bocal et du couvercle.

6.3 Assemblage de la chambre de sécurité

1.

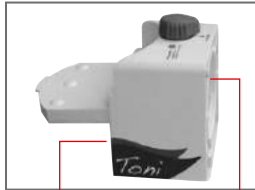

1.1 Ouvrir le couvercle de la chambre de sécurité.

2.

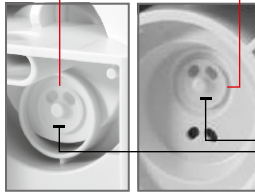

2.1 S'assurer que les deux valves (disques en silicone) sont fixées à la chambre de sécurité. Voir chapitre 4.

3.



3.1 S'assurer que le couvercle de la chambre de sécurité est bien fermé.

4.

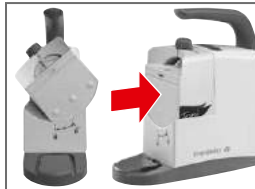

4.1 Maintenir la chambre de sécurité et l'incliner à 45° sur la gauche pour la fixer à l'unité moteur.

4.2 Tourner la chambre de sécurité en position verticale jusqu'à ce que vous entendiez un clic.

6.4 Fixation du bocal à l'aspirateur

1.



1.1 Fixer le bocal à l'aspirateur. Appuyer fermement.

2.



2.1 Attacher le tuyau à usage unique avec réglage au doigt sur l'embout d'aspiration.

7 Mode d'emploi



ATTENTION

Le Clario Toni doit être assemblé de manière à pouvoir gérer facilement une séparation entre l'aspirateur et les accessoires. Calibrer la batterie avant la première utilisation.



AVERTISSEMENTS

Le dispositif ne doit être utilisé que par du personnel spécialement formé aux méthodes d'aspiration et dans l'utilisation d'aspirateurs médicaux. Porter des gants lors de chaque utilisation.

7.1 Brancher Clario Toni au secteur

1. Vérifier l'aspirateur avant utilisation conformément aux instructions du chapitre 6.1.
2. **Pour tous les modèles : si l'aspirateur est relié au secteur,**
brancher la prise d'alimentation au secteur.

ou
Si l'aspirateur fonctionne avec une source d'alimentation de 12 V CC,
relier le câble optionnel de 12 V CC à l'aspiration et à la source d'alimentation de 12 V CC.

ou
Si l'aspirateur fonctionne sur batterie,
une connexion à une source d'alimentation n'est pas nécessaire. Veiller à ce que la batterie ait été chargée 5 heures.

7.2 Contrôle des fonctions avec de l'eau

1.

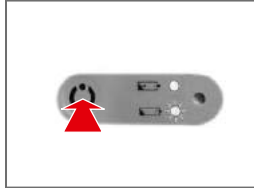

1.1 Appuyer sur le bouton Marche/Arrêt pour allumer l'aspirateur.

2.

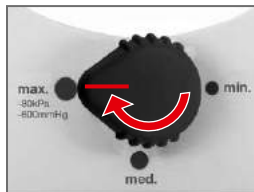

2.1 Mettre le régulateur de vide sur la position « max. ».

3.

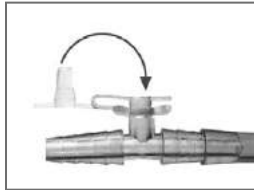

3.1 Fixer le tuyau avec réglage au doigt. Voir chapitre 6.4, étape 2.1.

3.2 Brancher l'embout avec réglage fin au doigt.

4.

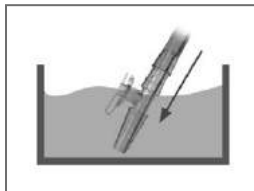

4.1 Placer l'embout avec réglage fin au doigt dans de l'eau et contrôler l'aspiration.

5. S'il y a une aspiration, passer à l'étape 6. Sinon, voir chapitre 13.

6. Utiliser une sonde ainsi que la puissance d'aspiration prescrite par le médecin.

7.3 Autre possibilité : contrôle des fonctions avec le manomètre en option



1.1 Fixer le manomètre optionnel
à l'embout d'aspiration.

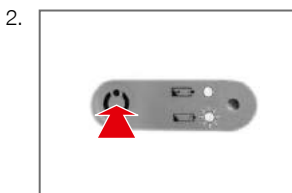

2.1 Appuyer sur le bouton
Marche/Arrêt pour
allumer l'aspirateur.

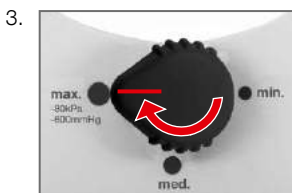

3.1 Mettre le régulateur de
vide en position « max. ».

Altitude
au-dessus
du niveau
de la mer :
▼
Vide
maximal :
▼

+ 2000 m	- 63 kPa - 471 mmHg
+ 1000 m	- 71 kPa - 532 mmHg
+ 500 m	- 76 kPa - 566 mmHg
0 m	- 80 kPa - 600 mmHg

(Tolérance : - 15 %)



4.1 Comparer le vide avec
les valeurs du tableau
sur la gauche.

5. Si le vide fonctionne, passer à l'étape 6. Sinon, voir chapitre 13.

6. Fixer le tuyau avec réglage au doigt.

7. Utiliser une sonde ainsi que la puissance d'aspiration
prescrite par le médecin.



AVERTISSEMENTS

Le dispositif ne doit être utilisé que par du personnel spécialement formé aux méthodes d'aspiration et dans l'utilisation d'aspirateurs médicaux. Porter des gants lors de chaque utilisation.

7.4 Modifier le niveau de vide

1.

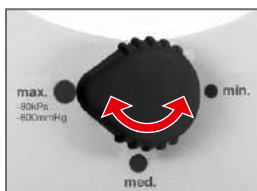

1.1 Mettre le régulateur de vide dans la position adéquate.

7.5 Mise hors tension après usage

1.

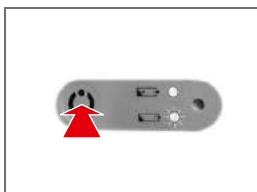

1.1 Appuyer sur le bouton Marche/Arrêt pour éteindre l'aspirateur.

2. Si l'aspirateur est relié au secteur :

Débrancher la prise d'alimentation du secteur.

ou

Si l'aspirateur est relié à une source d'alimentation de 12 V CC :

Débrancher la prise de 12 V CC de la source d'alimentation de 12 V CC.





3. Nettoyer et désinfecter le Clario Toni. Voir chapitre 16.

8 Vider le bocal

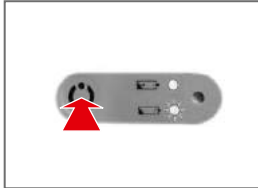

Conseils de sécurité

Le bocal doit être vidé tous les jours ou lorsque le niveau du fluide atteint 550 ml et que le clapet anti-débordement bloque l'aspiration.

1.  1.1 Appuyer sur le bouton Marche/Arrêt pour éteindre l'aspirateur.
2.  2.1 Débrancher le tuyau à usage unique avec réglage fin au doigt à l'embout d'aspiration.
2.2 Retirer le bocal de l'aspirateur.
3.  3.1 Fermer le bocal avec les bouchons lors des transports.
4. Vider le bocal et jeter le tuyau avec réglage fin au doigt conformément aux consignes locales et internes.
5.  5.1 Fixer un bocal propre.
5.2 Fixer un nouveau tuyau à usage unique avec réglage fin au doigt à l'embout d'aspiration.
6. Allumer l'aspirateur et régler le vide conformément à la prescription médicale.

9 Remplacer les membranes

1.  1.1 Retirer le bocal.

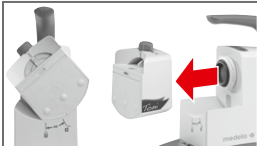
2.  2.1 Tourner la chambre de sécurité de 45° sur la gauche.
2.2 Retirer la chambre de sécurité en la tirant de l'aspirateur.

3.  3.1 Ouvrir la chambre de sécurité.

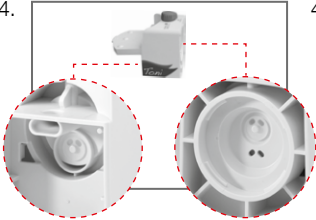
4.  4.1 Remplacer les membranes défectueuses. Veiller à la fixation correcte des nouvelles membranes.

5. Fixer la chambre de sécurité à l'aspirateur, comme décrit dans le chapitre 6.3.

10 Changement de la batterie



AVERTISSEMENTS

Avant de remplacer la batterie, éteindre le Clario Toni et débrancher-le du secteur.



Débrancher préalablement la prise d'alimentation du secteur.

1.

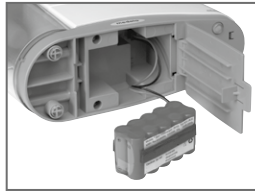

1.1 Ouvrir le couvercle du compartiment de la batterie, situé à la base du Clario Toni.

2.

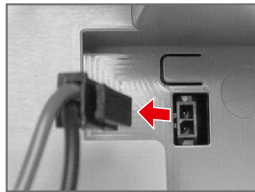

2.1 Détacher le câble de la batterie en tirant sur la prise.

3. Retirer l'ancienne batterie.

4. Insérer la nouvelle batterie.

5.

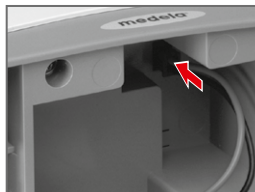

5.1 Rattacher le câble de la batterie en le branchant à la prise.

6. Fermer le couvercle du compartiment de la batterie. Veiller à ce que le couvercle soit bien fermé et que le câble de la batterie ne soit pas serré ou coincé.

7. Calibrer et tester la batterie (voir chapitres 11/12).

11 Informations de la batterie et test



ATTENTION

Ne recharger la batterie que lorsque l'indicateur de charge clignote lentement.

Durée de l'aspiration

Si la batterie est pleine, le temps de fonctionnement au vide maximal est > 50 minutes en moyenne.

Durée de charge (jusqu'à 100 %)

Environ 5 heures

État de la batterie

éteint

Batterie pleine

allumé

- La batterie est alors en charge
- L'aspirateur est branché

clignote lentement

La batterie est bientôt vide

clignote rapidement

La batterie est défectueuse

Test de la batterie

1. Veiller à ce que la batterie soit entièrement chargée.
2. Débrancher la prise d'alimentation du secteur.

3.

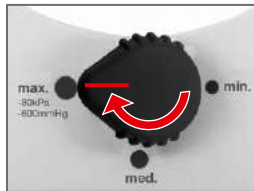

3.1 Mettre le régulateur de vide en position « max. ».

4.

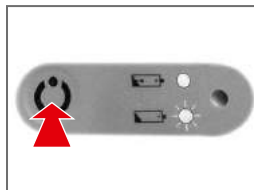

4.1 Allumer Clario Toni. L'aspirateur se met en route.

5. Déterminer le temps nécessaire à l'arrêt de l'aspirateur. La batterie est bonne, lorsque l'autonomie est > 50 minutes.

Si l'autonomie est < 50 minutes, refaire le test ou calibrer la batterie (voir page suivante).

12 Calibrage de la batterie



ATTENTION

Calibrer la batterie avant la première utilisation et après une durée d'entreposage > 2 mois. Changer la batterie si le calibrage n'a pas fonctionné.

Calibrage de la batterie NiMH

1. Veiller à ce que la batterie soit entièrement chargée.
2. Débrancher la prise d'alimentation du secteur.

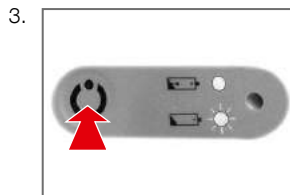

3.1 Allumer Clario Toni.
L'aspirateur se met en route.

3. Laisser l'aspirateur fonctionner jusqu'à ce que la batterie soit vide et que l'aspirateur s'arrête.
5. Brancher Clario Toni sur le secteur.
La batterie est en charge.
6. Attendre jusqu'à ce que le voyant s'éteigne.
7. Refaire les étapes 1 à 6. Le Clario Toni CA/CC est alors prêt à l'usage.

Entreposage de la batterie

Afin d'éviter au maximum que les batteries ne se déchargent, conserver le dispositif médical Clario Toni et les batteries de remplacement à part, à une température inférieure à 25 °C (77 °F). Refaire le procédé de calibrage tous les 60–90 jours.

13 Pannes et solutions

Le moteur ne fonctionne pas

Vérifier si :

- le Clario Toni est allumé.
- la tension secteur est correcte et si la prise secteur est bien raccordée à la prise murale.
- la batterie interne est chargée.

La pompe est trop bruyante

Contrôlez la position et l'étanchéité des 2 membranes dans la chambre de sécurité.

Vide insuffisant

Vérifier si :

- le régulateur de vide est correctement réglé.
- les tubulures ne sont pas défectueuses ni cassées. Remplacer si nécessaire.
- toutes les connexions sont bien insérées.
- le bocal d'aspiration et le couvercle ne sont ni fissurés, ni fragilisés, ni décolorés.
Remplacer si nécessaire.
- le joint de la membrane de la chambre de sécurité est étanche.
- la membrane est propre, sans fissure.

Autonomie de la batterie insuffisante

Calibrer l'état de la batterie. Voir chapitre 12.

Le voyant LED est éteint

La batterie est pleine.

Le voyant LED est allumé

- La batterie est en charge.
- L'aspirateur est branché.

Le voyant LED clignote lentement

La batterie rechargeable est bientôt vide. La charge de la batterie est suffisante pour environ 10 minutes d'aspiration.

Le voyant LED clignote rapidement

La batterie est défectueuse. Pour remplacer une batterie défectueuse, voir chapitre 10.

14 Garantie et maintenance

Garantie

Les dispositifs de Medela AG sont garantis exempts de toute défectuosité matérielle ou de main d'œuvre pendant une période de 2 ans à compter de la date de livraison (pendant 6 mois pour la batterie). Les produits défectueux sont remplacés gratuitement pendant cette période, pour autant que le défaut ne provienne pas d'un usage abusif ou inadéquat. Cette garantie ne s'applique pas aux pièces d'usure. Pour assurer l'applicabilité de la présente garantie ainsi qu'un fonctionnement optimal des produits Medela, nous recommandons d'utiliser exclusivement des accessoires Medela avec nos appareils.

La responsabilité de Medela ne saurait être engagée en cas de plainte dépassant le champ d'application de la présente garantie, notamment en cas de dommage indirect, etc. Medela refuse le remplacement de pièces défectueuses en cas de manipulations effectuées sur l'aspirateur par des personnes non autorisées. La présente garantie est soumise au retour de l'appareil dans un centre de service Medela.

Maintenance

Les travaux d'entretien ne doivent être effectués qu'aux endroits autorisés par Medela. Le manuel d'entretien Medela est disponible sur demande.

15 Élimination

Le Clario Toni intègre des pièces en métal et en plastique qu'il convient d'éliminer conformément aux directives européennes 2011/65/CE et 2012/19/CE. Observer les réglementations locales complémentaires. Pour les versions CA/CC, les pièces électroniques et la batterie doivent être jetées ou détruites séparément, conformément aux recommandations locales en vigueur. Veillez à éliminer le Clario Toni et ses accessoires conformément aux directives d'élimination locales.



Informations destinées à l'utilisateur pour l'élimination des appareils électriques et électroniques

Ce symbole signifie que les appareils électriques et électroniques ne peuvent être éliminés comme les déchets ménagers classiques. Une élimination correcte de ce dispositif protège l'environnement et la santé publique contre d'éventuels dommages. Pour plus d'informations sur l'élimination des appareils, veuillez contacter le fabricant, votre personnel soignant local ou votre fournisseur de soins de santé. Ce symbole est uniquement valable dans l'Union européenne. Veuillez respecter les lois et réglementations nationales en vigueur dans votre pays au sujet de l'élimination des appareils électriques et électroniques.

16 Consignes de nettoyage



AVERTISSEMENTS

Après chaque utilisation, les éléments ayant été en contact avec les sécrétions aspirées doivent être nettoyés, désinfectés, stérilisés ou éliminés **conformément au tableau de la page suivante**.



Avant le nettoyage, débrancher la prise d'alimentation du secteur.

Remarques générales

- Les présentes recommandations sont données à titre général et peuvent être adaptées en fonction de cas particulier, selon les directives propres à l'hôpital et les pratiques et politiques de nettoyage en vigueur.
- Informations détaillées conformément aux consignes de nettoyage de Medela (code produit n° 200.2391).
- Porter des gants de protection pour le nettoyage/la désinfection.
- Éliminer les fluides tels que le sang et les sécrétions et les éléments qu'ils ont contaminés, et ce conformément aux directives internes de l'hôpital.

Produits nettoyants de surface recommandés par Medela pour le boîtier de l'aspirateur

- **CaviWipes**, Metrex Research, www.sybrondental.com
- **mikrozid® AF wipes**, Schülke&Mayr GmbH, www.schuelke.com

Eau

Utiliser toujours l'eau la plus pure pour nettoyer l'appareil. La dureté de l'eau doit être sérieusement prise en considération, car les dépôts sur les appareils médicaux peuvent persister. Utiliser de l'eau désionisée pour réduire ce problème. L'eau de rinçage finale ne contient ni bactéries ni endotoxines.

Machines de nettoyage/désinfection

Peut être utilisé pour désinfecter des pièces sur tableau sur la prochaine page. Un rinçage à l'eau chaude (température maximale 100 °C) peut assurer une désinfection moyenne à élevée. La moindre partie des composants doit pouvoir être accessible pour assurer un nettoyage efficace. Nous recommandons d'utiliser une machine de nettoyage/désinfection approuvée par l'institut Robert Koch et satisfaisant à la norme ISO 15883. La température recommandée pour les dispositifs médicaux non critiques (c.-à-d. ceux qui entrent uniquement en contact avec de la peau non abîmée) est de 90 °C pour 1 minute. Le temps de désinfection passe à 5 minutes pour tous les dispositifs médicaux considérés comme critiques.



Produits à usage unique

Il s'agit de produits à usage unique non destinés à être retraités. Tout retraitement est susceptible d'entraîner la perte des propriétés mécaniques, chimiques et/ou biologiques. Toute réutilisation pourrait entraîner une contamination croisée.

Bocal, chambre de sécurité	Boîtier d'aspirateur Câble secteur	
x	x	<p>1. Démontage Séparer toutes les pièces avant de nettoyer, de désinfecter et de stériliser le dispositif.</p>
x		<p>2. Nettoyer le bocal, la chambre de sécurité Nettoyer les composants à l'eau chaude (60–70 °C) contenant un détergent au PH compris entre 6,0 et 8,0 uniquement, afin d'éviter d'endommager les instruments et récipients. Les détergents enzymatiques favorisent l'élimination des substances organiques, comme le sang. Les détergents doivent être utilisés en respectant les niveaux de concentration recommandés par leur fabricant. Certains détergents alcalins ont été formulés pour permettre un retraitement en toute sécurité des dispositifs médicaux. Les fabricants de ces détergents doivent fournir des informations sur les matériaux susceptibles d'être endommagés par leurs détergents. Immerger complètement les pièces dans de l'eau chaude et savonneuse ou dans un détergent enzymatique pendant 1 à 5 minutes. 1. Éliminer les salissures visibles avec un outil de nettoyage - des brosses de nettoyage classiques telles que des écouvillons ou des chiffons anti-peluches non abrasifs. Les brosses pour le nettoyage des tuyaux doivent s'introduire aisément, tout en se déplaçant facilement dans la zone à nettoyer. Rincer minutieusement à l'eau claire. Laisser sécher. 2. Vérifier qu'il ne reste aucune saleté visible sur les instruments. Répéter la procédure si nécessaire.</p>
	x	<p>3. Nettoyer le boîtier de pompe, le câble d'alimentation Frotter avec un détergent indiqué ci-dessus. Sécher à l'aide d'un linge propre.</p>
x		<p>4. Désinfecter Laisser tremper à température ambiante pendant 30 minutes dans une solution de désinfection/de nettoyage (A). Une fois le temps d'action écoulé, éliminer les restes de solution des différentes pièces avec de l'eau et rincer le tuyau. Rincer pendant 2 minutes au moins avec la solution de nettoyage (B).</p> <p>(A) solution de désinfection fluide sans aldéhyde, avec effet nettoyant, à utiliser comme solution de trempage, bactéricide, fongicide, virucide (certains virus), compatible avec l'acier inoxydable, les métaux non ferreux et les plastiques tels que la silicone, légèrement alcaline, p.ex. 2 % neodisher® Septo MEDsolution.</p> <p>(B) Solution de nettoyage enzymatique fluide, au PH neutre, destinée au traitement mécanique ou manuel d'instruments, hautement compatible avec l'acier inoxydable, les métaux non ferreux et les plastiques, notamment le silicone.</p> <p>ou utiliser une machine de nettoyage/désinfection. ou utiliser un lave-vaisselle.</p>
x		<p>5. Stockage des composants Après la désinfection, mettez en réserve les composants sur un drap propre et sec.</p>



17 Aperçu des accessoires



AVERTISSEMENTS

Clario Toni a été contrôlé en association avec les accessoires repris ci-dessous. Pour une utilisation adéquate et sûre du Clario Toni, utiliser uniquement ces accessoires. Plus d'informations figurent sur la fiche d'instruction de chaque accessoire.

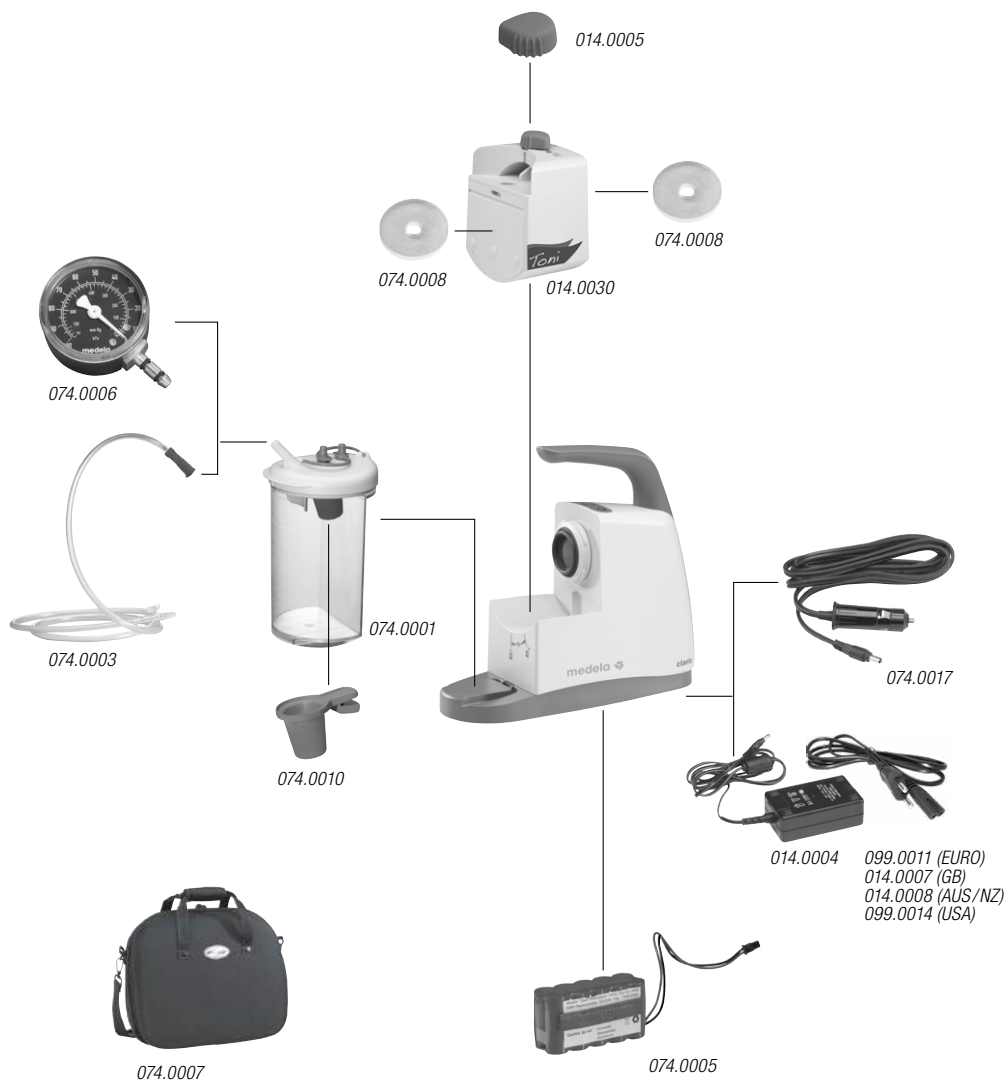

18 Légende des accessoires



Conseils de sécurité

Lorsque l'aspirateur est utilisé avec des accessoires non fournis par Medela, ceux-ci doivent :

- porter la marque CE et (si nécessaire) avoir été enregistrés au niveau local ;
- pouvoir être fixés aux accessoires Medela de manière sûre, sans nuire au bon fonctionnement de l'aspirateur.

Remarque : en associant des pièces Medela avec des pièces non fournies par Medela, vous assumez la responsabilité du système entier.

REF

014.0030	Chambre de sécurité
014.0005	Régulateur de vide
074.0008	Membranes (10 unités)
074.0001	Set bocal
074.0010	Valve anti-débordement (10 unités)
074.0003	Tuyau à usage unique avec réglage au doigt
074.0005	Batterie rechargeable
014.0004	Adaptateur secteur
099.0011	Câble d'alimentation (EURO)
099.0014	Câble d'alimentation (USA)
014.0007	Câble d'alimentation (GB)
074.0007	Sac de transport
074.0017	Câble auto pour alimentation 12 V CC
074.0006	Manomètre

19 Signes et symboles



Ce symbole indique que l'appareil est conforme aux dispositifs élémentaires de la directive 93/42/CEE du Conseil du 14 juin 1993 relative aux dispositifs médicaux.



Ce symbole indique que l'appareil est conforme aux normes de sécurité établies par les États-Unis et le Canada pour les appareils électromédicaux.



Ce symbole indique les spécifications légales de l'aspirateur.



Ce symbole indique qu'il convient de suivre le mode d'emploi.



Ce symbole indique qu'il convient de consulter le mode d'emploi.



Ce symbole indique une MISE EN GARDE ou un AVERTISSEMENT associé au dispositif.



Ce symbole indique un conseil de sécurité.



Ce symbole indique la classe de l'aspirateur.



Ce symbole indique un appareil de classe II.

IP21

Ce symbole indique une protection contre les effets nocifs de l'introduction d'objets étrangers solides et de gouttes d'eau.



Ce symbole indique une partie appliquée de type BF.



Ce symbole indique INCOMPATIBILITÉ RM.



Ce symbole indique que des interférences peuvent se produire en présence d'équipements portant le même symbole.



Ce symbole indique le fabricant.



Ce symbole indique la date de fabrication de l'appareil (quatre chiffres pour l'année et deux chiffres pour le mois).



Ce symbole indique que l'appareil ne doit pas être utilisé après la fin du mois et de l'année mentionnés.



Ce symbole indique un dispositif à usage unique. Ne pas réutiliser le dispositif.

REF

Ce symbole indique le numéro de catalogue du fabricant.

SN

Ce symbole indique le numéro de série du fabricant.

LOT

Ce symbole indique le numéro de lot.

STERILEEO

Ce symbole indique que l'appareil est stérilisé à l'oxyde d'éthylène.



Ce symbole indique la limite de température pour l'utilisation, le transport et l'entreposage de l'appareil.



Ce symbole indique le taux d'humidité maximal à prendre en compte pour l'utilisation, le transport et l'entreposage de l'appareil.



Ce symbole indique la limite de pression atmosphérique à prendre en compte pour l'utilisation, le transport et l'entreposage de l'appareil.



Ce symbole indique qu'il ne faut pas utiliser l'appareil si l'emballage est endommagé.



Ce symbole indique le nombre d'articles pouvant être traités par le contenu de l'emballage.



Ce symbole indique que l'appareil ne peut être éliminé avec les déchets municipaux non triés (uniquement pour l'UE).



Ce symbole indique que le matériel fait partie d'un processus de récupération/recyclage.



Ce symbole indique un emballage en carton.



Ce symbole indique que le dispositif doit être conservé à l'abri de la lumière du soleil.



Ce symbole indique que l'appareil est fragile et doit être manipulé avec précaution.



Ce symbole indique que l'appareil doit être maintenu au sec.



Ce symbole indique le niveau de vide maximal de l'aspirateur.



Ce symbole indique les niveaux de débit de l'aspirateur.



Ce symbole indique les spécifications électriques de l'aspirateur.



Ce symbole indique du courant alternatif.



Ce symbole indique du courant continu.



Ce symbole indique le poids de l'aspirateur.



Ce symbole indique les dimensions (h x l x p) de l'aspirateur.



Ce symbole indique un dispositif sur prescription. ATTENTION : La loi fédérale américaine limite la vente de ce dispositif à un médecin ou sur ordonnance d'un médecin (USA uniquement).



Ce symbole indique le nombre d'articles.

20 Spécifications techniques



vide min., - 70 mmHg / - 9 kPa (+/- 20 mmHg / +/- 2.6 kPa)
vide moyen, - 115 mmHg / - 15 kPa (+/- 30 mmHg / +/- 4 kPa)
vide max., - 600 mmHg / - 80 kPa (- 90 mmHg / - 12 kPa)

Mesuré à 0 m ; pression atmosphérique : 1 013 hPa

Note : les niveaux de vide peuvent varier en fonction de la situation géographique (nombre de mètres au-dessus du niveau de la mer, pression atmosphérique et température).



Débit réduit : 15 l/min. (+/- 10%)



2,0 kg / 4,4 lbs
Sans bocal



100-240 V, 50-60 Hz
12 V, 3,4 A, NiMH
Adaptateur secteur
UE48-120340SPA1



ISO 13485
93/42 CEE Classe IIa



h x l x p
223 x 255 x 95 mm



15% / 93%
-20 / +50 °C
70 / 106 kPa
Transport/stockage



+25 °C
Transport/stockage
Batterie rechargeable



15% / 93%
+5 / +40 °C
70 / 106 kPa
Fonctionnement



IP21

21 Documentation technique



AVERTISSEMENTS

Ne pas utiliser d'autres accessoires que ceux spécifiés ou vendus par le fabricant pour remplacer des composants internes, sous peine d'entraîner une augmentation des émissions ou une diminution de l'immunité de l'aspirateur Clario Toni.

Les équipements chirurgicaux à HF (haute fréquence), les réseaux de radio ou similaires peuvent avoir une influence sur le fonctionnement du dispositif et ne doivent pas être utilisés en même temps que le dispositif médical Clario Toni.

CEM

Le dispositif médical Clario Toni a fait l'objet d'une évaluation de la compatibilité électromagnétique en conformité avec les normes CEI 60601-1-2:2007 et CEI 60601-1-2:2014 4e édition selon les clauses 7 et 8.9. Clario Toni est un appareil médical qui impose des mesures de sécurité particulières et qui doit être installé et mis en service conformément aux informations annexées concernant les CEM.

Voir également les pages 326 à 329.

Indice

Congratulazioni	100
1 Avvertenze e istruzioni di sicurezza	101
Istruzioni di sicurezza	103
2 Alimentazione elettrica e funzionamento a batteria	104
Batteria quasi scarica	104
Batteria scarica.....	104
3 Descrizione	105
Introduzione.....	105
Uso previsto/Indicazioni.....	105
Controindicazioni.....	105
Utente destinatario	105
Categoria di pazienti destinatari	105
Nota importante.....	105
4 Panoramica	106
Definizione di vuoto	106
Versioni dell'aspiratore.....	106
Componenti principali dell'aspiratore.....	106
Posizione della membrana	107
Dischi della valvola nella camera di sicurezza	107
Comandi e stato della batteria.....	107
5 Installazione	108
Verifica iniziale alla consegna	108
6 Preparazione per l'utilizzo	109
Verifiche prima dell'utilizzo.....	109
Montaggio del contenitore.....	109
Montaggio della camera di sicurezza	110
Collegamento del contenitore all'aspiratore	110
7 Istruzioni per la messa in funzione	111
Collegamento di Clario Toni all'alimentazione di rete.....	111
Verifica del funzionamento con acqua.....	112
Alternativa: verifica del funzionamento con il manometro per vuoto opzionale	113
Modifica del livello di vuoto.....	114
Spegnimento dopo l'utilizzo.....	114
8 Svuotamento del contenitore	115
9 Sostituzione dei dischi della valvola	116

10	Sostituzione della batteria	117
11	Dati e test della batteria	118
	Durata di pompaggio.....	118
	Tempo di carica (carica fino al 100%).....	118
	Stato della batteria	118
	Test della batteria	118
12	Calibrazione della batteria	119
	Calibrazione della batteria NiMH	119
	Conservazione della batteria	119
13	Risoluzione guasti	120
	Il motore non gira.....	120
	L'aspiratore è troppo rumoroso	120
	Vuoto insufficiente	120
	Durata del funzionamento a batteria insufficiente.....	120
	Nessun LED acceso	120
	LED acceso	120
	Il LED lampeggia lentamente	120
	Il LED lampeggia velocemente	120
14	Garanzia e manutenzione	121
	Garanzia	121
	Manutenzione	121
15	Smaltimento	121
16	Linee guida per la pulizia	122
	Note generali	122
	Detergenti per superfici raccomandati da Medela per l'involucro dell'aspiratore	122
	Acqua	122
	Lavatrici/disinfettatrici	122
	Prodotti monouso.....	122
17	Panoramica degli accessori	124
18	Legenda accessori	125
19	Segni e simboli	126
20	Dati tecnici	128
21	Documentazione tecnica	129
	Documentazione tecnica/EMC.....	326

Congratulazioni

Scegliendo Clario Toni, avete acquistato un'aspiratore di alta qualità adattabile alle vostre esigenze a seguito di prescrizione medica. Questo prodotto è semplice da usare e da pulire ed evita efficacemente che il liquido aspirato possa traboccare. Funziona mediante un sistema a membrana con un motore elettrico. La forza di aspirazione può essere regolata nella misura desiderata, grazie a 3 intensità differenti del vuoto. Come tutti gli aspiratori Medela, questo dispositivo assicura un'aspirazione semplice e affidabile. La semplicità di uso e di pulizia, insieme alle caratteristiche di sicurezza, rappresentano ulteriori vantaggi per chi ha scelto questo modello. Contattateci, saremo lieti di offrirvi la nostra assistenza!

1 Avvertenze e istruzioni di sicurezza



AVVERTENZA

Indica una situazione potenzialmente pericolosa che, se non evitata, può condurre alla morte o a gravi lesioni.



ATTENZIONE

Indica una situazione potenzialmente pericolosa che, se non evitata, può condurre a lesioni moderate o lievi.



Suggerimento relativo alla sicurezza

Indica informazioni utili per l'utilizzo in sicurezza del dispositivo.

Il modello Clario Toni è approvato esclusivamente per l'utilizzo descritto nelle presenti istruzioni per l'uso. Medela può garantire il funzionamento sicuro del sistema solo se il dispositivo Clario Toni è utilizzato in combinazione con accessori originali Medela. Vedere i capitoli 17/18.

Leggere e osservare le seguenti avvertenze e istruzioni di sicurezza prima dell'utilizzo. Conservare le presenti istruzioni per l'uso insieme al dispositivo per successive consultazioni.

Le presenti istruzioni per l'uso costituiscono una guida generale per l'impiego del prodotto. Per qualsiasi questione medica rivolgersi a un medico.

Medela si ritiene responsabile esclusivamente per gli effetti sulla SICUREZZA DI BASE, per l'affidabilità e per le prestazioni dell'aspiratore Clario Toni, purché utilizzato in conformità con le istruzioni per l'uso.

ATTENZIONE: la legge federale statunitense limita la vendita di questo dispositivo ai medici o su loro prescrizione.

Soggetto a modifiche.



AVVERTENZA

- Il dispositivo è destinato al solo uso da parte di persone esperte con conoscenze adeguate in materia di procedure di aspirazione e uso di aspiratori.
- Per i pazienti nei quali il mancato funzionamento del dispositivo può causare una situazione critica (es. pazienti con insufficienza respiratoria acuta o forte ostruzione mucosa) predisporre un dispositivo sostitutivo.
- Il dispositivo non deve essere utilizzato per l'aspirazione di liquidi esplosivi, facilmente infiammabili o corrosivi.
- Il tubo di collegamento fornito con il dispositivo non deve essere mai messo a diretto contatto con la zona di aspirazione. Deve sempre essere utilizzato un catetere di aspirazione sterile (rischio di infezione).
- Prima di pulire il dispositivo, estrarre la spina dalla presa di rete a muro.
- Non sono consentite modifiche al dispositivo.
- Non connettere questo dispositivo a un tubo di drenaggio a caduta.
- Prima di utilizzare l'aspiratore Clario Toni, consultare le indicazioni per l'uso e prendere in considerazione i fattori di rischio e le controindicazioni. La mancata lettura e osservanza di tutte le istruzioni contenute nel presente manuale prima dell'uso del prodotto possono provocare il decesso o gravi lesioni al paziente.
- Non usare Clario Toni in un ambiente di risonanza magnetica (MRI).
- La rete di alimentazione può essere danneggiata mediante scariche elettrostatiche di 15 kV sulla porta CC.



ATTENZIONE

- Un uso non corretto può causare dolore e danni al paziente.
- Non utilizzare accessori sterili se la confezione sterile è danneggiata.
- Le apparecchiature di comunicazione wireless, come dispositivi di rete domestica wireless, telefoni cellulari, cordless e relative stazioni base e ricetrasmittitori palmari, possono influenzare il funzionamento di Clario Toni e devono essere mantenute a una distanza di almeno 30 cm.
- Dispositivi di comunicazione in radiofrequenza portatili e mobili possono pregiudicare il funzionamento del dispositivo.



Suggerimento relativo alla sicurezza

- Per quanto concerne i test di sicurezza, si presuppone che il dispositivo sia sottoposto a manutenzione e riparazione per tutta la durata di servizio in conformità con le istruzioni per l'assistenza tecnica. Poiché l'aspiratore Clario Toni è un dispositivo appartenente alla classe di sicurezza II (EN IEC 60601-1, A1, A2:1995), i test di sicurezza sono limitati a un controllo visivo dell'involucro e del cavo di alimentazione. Questo test deve essere eseguito prima di ogni utilizzo.
- Test della corrente di dispersione nel paziente: consultare il manuale di assistenza tecnica per dettagli.
- La protezione dell'aspiratore Clario Toni contro gli effetti di scarica di un defibrillatore cardiaco dipende dall'impiego dei cavi appropriati.
- La separazione del dispositivo dalla rete elettrica è garantita solo tramite l'interruzione del collegamento tra la spina e la presa di rete a muro.
- Prima di inserire la spina del dispositivo nella presa di corrente, verificare che la rete elettrica locale abbia la stessa tensione specificata sulla targhetta con i dati tecnici del dispositivo.

Istruzioni di sicurezza

- L'aspiratore Clario Toni di Medela è un dispositivo elettromedicale che richiede speciali misure di sicurezza con riguardo alla compatibilità elettromagnetica. Deve essere installato e messo in servizio in conformità con le informazioni sulla compatibilità elettromagnetica allegate.
- Non utilizzare il dispositivo in nessuno dei seguenti casi, esso dovrà essere riparato dal servizio assistenza:
 - se il cavo di alimentazione elettrica o la spina sono danneggiati;
 - se il dispositivo non funziona perfettamente;
 - se il dispositivo è danneggiato;
 - se il dispositivo presenta difetti evidenti che ne pregiudicano la sicurezza.
- Tenere sempre il cavo di alimentazione elettrica lontano da fonti di calore.
- La spina per il collegamento alla rete elettrica e l'interruttore ON/OFF devono essere tenuti lontano dall'umidità.
- Non tirare mai il cavo di alimentazione per estrarre la spina dalla presa di rete elettrica!
- Non lasciare mai il dispositivo incustodito quando è acceso.
- Durante l'uso, l'aspiratore deve essere in posizione verticale.
- Non avvolgere mai il cavo di alimentazione intorno al collo.
- Non utilizzare mai il dispositivo in presenza di elevata temperatura ambiente, durante il bagno o la doccia, quando si è molto stanchi o in un ambiente a rischio di esplosione.
- Non immergere mai il dispositivo in acqua o altri liquidi.
- Ove si tratti di prodotti sterili monouso, ricordare che non sono destinati a essere sterilizzati. Tale procedura potrebbe causare la perdita di caratteristiche meccaniche, chimiche e/o biologiche. Il riuso può causare infezioni crociate.
- Contattare il responsabile del Servizio Clienti Medela di zona per ricevere assistenza sull'uso del prodotto.
- Per qualsiasi uso dell'aspiratore, mettersi sempre i guanti.

Tenere le istruzioni per l'uso a portata di mano per una futura consultazione.

2 Alimentazione elettrica e funzionamento a batteria

Clario Toni è un aspiratore alimentato dalla rete elettrica o dalla batteria. Prima di inserire la spina del dispositivo nella presa di corrente, verificare che la rete elettrica locale abbia la stessa tensione specificata sulla targhetta con i dati tecnici del dispositivo. Se utilizzato secondo quanto descritto nella presente guida per l'utente, il modello Clario Toni CA/CC dispone di un'autonomia massima di 50 minuti prima che si renda necessario ricaricare la batteria. Se il modello Clario Toni CA/CC non è utilizzato, la batteria deve essere calibrata ogni 60–90 giorni.

Batteria quasi scarica

Durante il funzionamento a batteria, l'indicatore a LED lampeggia lentamente, segnalando che la batteria sta per scaricarsi. Clario Toni resta in funzione ancora per breve tempo (~10 minuti), ma la batteria deve essere ricaricata non appena possibile.

Batteria scarica

Quando la batteria è completamente scarica, l'aspiratore si arresta. Non è più assicurato il corretto funzionamento dell'aspiratore. La batteria deve essere ricaricata o sostituita.

3 Descrizione

Introduzione

Il modello Clario Toni è un aspiratore di alta qualità. È alimentato dal comprovato sistema a membrana. Associa in modo ideale la facilità d'uso e di pulizia con caratteristiche di sicurezza che garantiscono un funzionamento ottimale. Usare solo attenendosi alle istruzioni del medico curante e dopo aver ricevuto istruzioni da esperti specialisti.

Uso previsto

Gli aspiratori Clario Toni sono destinate all'aspirazione e alla rimozione delle secrezioni, dei fluidi corporei e dei corpi estranei dalle vie respiratorie del paziente o dai sistemi di supporto respiratorio nel tratto nasale, faringeo e tracheale dei pazienti pediatrici o adulti. Questo aspiratore è idoneo per l'uso domestico, in ospedale, in auto o all'aperto.

Indicazioni

L'aspiratore Clario Toni è destinato alla pulizia delle vie aeree attraverso il naso, la bocca o il tubo di tracheostomia.

Controindicazioni

Il dispositivo non è idoneo per l'aspirazione prolungata.

Utente destinatario

L'aspiratore Clario Toni deve essere messo in funzione esclusivamente da utenti opportunamente formati. Le persone addette all'uso devono disporre di un buon udito e di un'acutezza visiva adeguata. La formazione deve prevedere un aggiornamento almeno una volta all'anno.

Categoria di pazienti destinatari

L'aspiratore Clario Toni è destinato all'uso su pazienti che presentano esclusivamente le condizioni descritte nelle indicazioni per l'uso.

Nota importante

Il medico è responsabile del rispetto delle procedure e delle tecniche operatorie corrette. Ogni medico deve valutare se il trattamento è adeguato, basandosi sulle proprie conoscenze e sulla propria esperienza.

4 Panoramica

Definizione di vuoto

Durante l'applicazione di dispositivi medicali di aspirazione, il vuoto viene creato generalmente per differenza (in cifre assolute) tra la pressione assoluta e la pressione atmosferica o come valori negativi in chilopascal (kPa). Nel presente documento l'indicazione di -10 kPa, ad esempio, è sempre riferita a un intervallo di pressione in kPa al di sotto della pressione atmosferica (conformemente alla norma EN ISO 10079:1999).

Versioni dell'aspiratore



Clario Toni CA/CC

Componenti principali dell'aspiratore

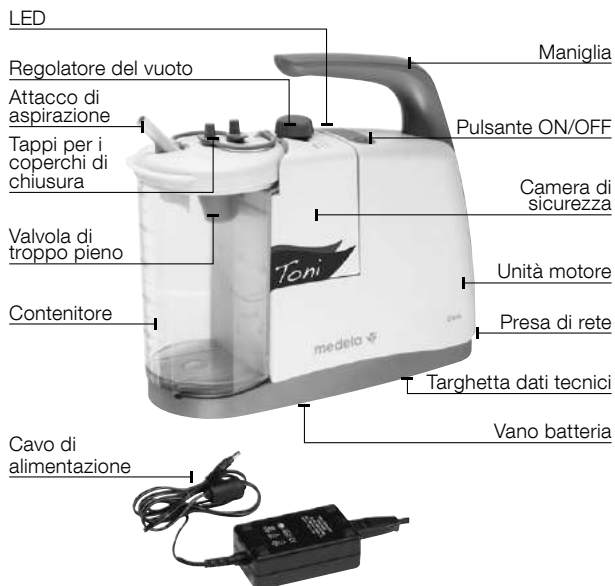

Posizione della membrana

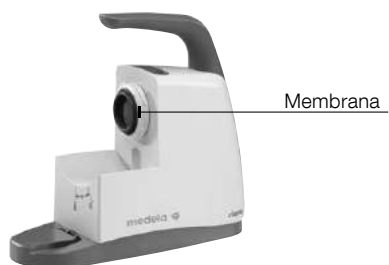

Dischi della valvola nella camera di sicurezza

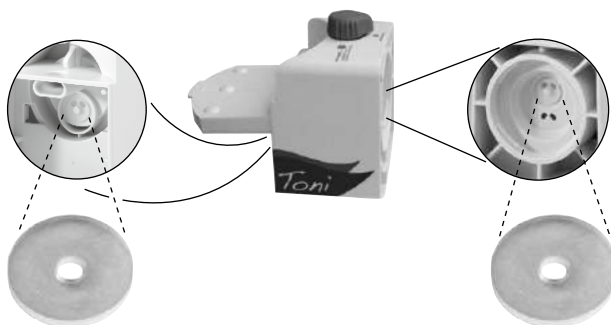

Comandi e stato della batteria

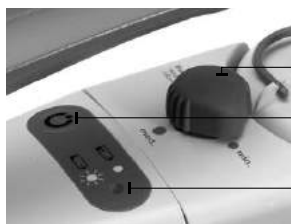

- | | |
|------------------------------|--|
| non acceso | Batteria carica |
| acceso | - Batteria in carica
- Aspiratore collegato alla rete elettrica |
| lampeggia lentamente | Batteria quasi scarica |
| lampeggia velocemente | Batteria guasta |

5 Installazione

Verifica iniziale alla consegna

Verificare la completezza e le condizioni generali del contenuto della confezione Clario Toni.



Versioni Clario Toni

REF	Clario Toni CA/CC	014.00XX
	Clario Toni Deluxe	014.00XX



Tubicino monouso con fingertip

REF	074.0003
------------	----------



Adattatore di alimentazione

REF	014.0004
------------	----------

Cavo di alimentazione

099.0011 (Euro)

014.0007 (UK)

014.0008 (AUS/NZ)

099.0014 (USA)



Istruzioni per l'uso

REF	200.8400
------------	----------



AVVERTENZE

Il tubo di collegamento fornito con il dispositivo non deve essere mai messo a diretto contatto con la zona di aspirazione. Si deve utilizzare sempre un catetere di aspirazione sterile (rischio di infezioni).

6 Preparazione per l'utilizzo



AVVERTENZA

Il dispositivo è destinato al solo uso da parte di persone esperte con conoscenze adeguate in materia di procedure di aspirazione e uso di aspiratori. Per qualsiasi uso dell'aspiratore, mettersi sempre i guanti.



ATTENZIONE

- Durante l'uso, l'aspiratore Clario Toni deve essere in posizione verticale.
- Verificare l'integrità della confezione degli accessori sterili prima di utilizzarli.
- Gli accessori non sterili e riutilizzabili devono essere puliti, disinfettati e/o sterilizzati secondo la guida alla pulizia Medela (codice prodotto 200.2391).

6.1 Verifiche prima dell'utilizzo

- Prima dell'uso, verificare il sistema Clario Toni per individuare eventuali danni al cavo o alla spina di alimentazione, danni evidenti al dispositivo o difetti che compromettano la sicurezza e il corretto funzionamento del dispositivo.
- Verificare la completezza e le condizioni generali della confezione dell'aspiratore Clario Toni.
- Accertarsi che la batteria sia calibrata secondo quanto riportato nel capitolo 12.
- Verificare tutti gli accessori prima dell'utilizzo, come segue.
 - Contenitore e coperchio per individuare rotture, punti fragili e difetti. Se necessario, sostituire.
 - Tubi, per individuare rotture e punti fragili; verificare che i connettori siano collegati saldamente. Se necessario, sostituire.

6.2 Montaggio del contenitore

1.





1.1 Collegare la valvola di troppo pieno al contenitore.

2.



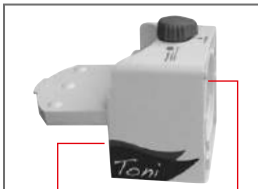
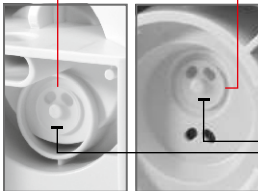

2.1 Porre il coperchio sul contenitore. Prestare attenzione alle marcature nella parte anteriore del contenitore e del coperchio.

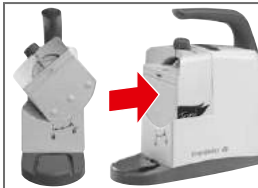
6.3 Montaggio della camera di sicurezza

1.  1.1 Aprire il coperchio della camera di sicurezza.
2.  2.1 Verificare che le due valvole (dischi in silicone) siano fissate alla camera di sicurezza. Consultare il capitolo 4.
3.  3.1 Verificare che il coperchio della camera di sicurezza sia ben chiuso.
4.  4.1 Tenendo la camera di sicurezza, inclinarla di 45° a sinistra per fissarla all'unità motore.
4.2 Ruotare la camera di sicurezza in posizione verticale fino a udire un clic.

6.4 Collegamento del contenitore all'aspiratore

1.  1.1 Collegare il contenitore all'aspiratore. Premere con decisione.
2.  2.1 Collegare il tubicino monouso con fingertip all'attacco di aspirazione.

7 Istruzioni per la messa in funzione



ATTENZIONE

L'aspiratore Clario Toni deve essere configurato in modo da facilitarne la separazione dall'alimentazione di rete. Calibrare la batteria prima del primo utilizzo.



AVVERTENZA

Il dispositivo è destinato al solo uso da parte di persone esperte con conoscenze adeguate in materia di procedure di aspirazione e uso di aspiratori. Per qualsiasi uso dell'aspiratore, mettersi sempre i guanti.

7.1 Collegamento di Clario Toni all'alimentazione di rete

1. Verificare l'aspiratore prima dell'uso seguendo le istruzioni al capitolo 6.1.

2. **Per tutti i modelli: se l'aspiratore è collegato a una presa di rete a muro,**

inserire la spina del cavo di alimentazione in una presa di rete a muro;

oppure

Se l'aspiratore funziona con alimentazione a 12 VCC,

collegare il cavo opzionale a 12 VCC all'aspiratore e alla fonte di alimentazione a 12 VCC;

oppure

Se l'aspiratore funziona a batteria,

non occorre alcun collegamento a fonti di alimentazione. Accertarsi che la batteria sia rimasta in carica per cinque ore.

7.2 Verifica del funzionamento con acqua

1.

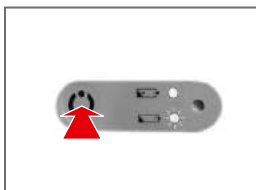

1.1 Premere il pulsante ON/OFF per accendere l'aspiratore.

2.

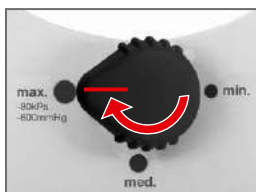

2.1 Impostare il regolatore del vuoto sulla posizione "max.".

3.

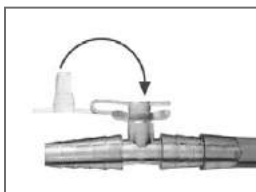

3.1 Collegare il tubicino con fingertip.
Consultare il capitolo 6.4, operazione 2.1.
3.2 Inserire l'attacco fingertip.

4.

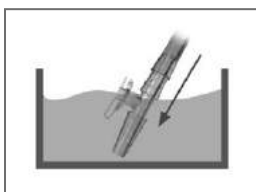

4.1 Immergere il fingertip in acqua e controllare che sia presente l'aspirazione.

5. Se l'aspirazione è presente, procedere con il punto 6. In caso contrario, consultare il capitolo 13.

6. Utilizzare il catetere e l'impostazione di vuoto come prescritto dal medico.

7.3 Alternativa: verifica del funzionamento con il manometro per vuoto opzionale per vuoto opzionale



1.1 Collegare il manometro per vuoto opzionale all'attacco di aspirazione.

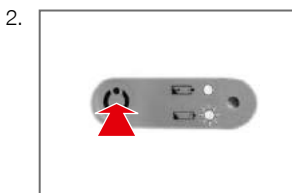

2.1 Premere il pulsante ON/OFF per accendere l'aspiratore.

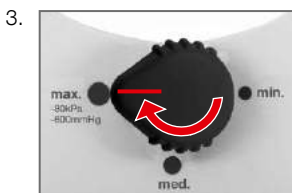

3.1 Impostare il regolatore del vuoto sulla posizione "max.".

Altitudine sul livello del mare	Vuoto massimo
+ 2000 m	- 63 kPa - 471 mmHg
+ 1000 m	- 71 kPa - 532 mmHg
+ 500 m	- 76 kPa - 566 mmHg
0 m	- 80 kPa - 600 mmHg

(Tolleranza: - 15 %)



4.1 Confrontare il vuoto con i valori della tabella riportata a sinistra.

5. Se il vuoto è OK, procedere con il punto 6. In caso contrario, consultare il capitolo 13.

6. Collegare il tubicino con fingertip.

7. Utilizzare il catetere e l'impostazione di vuoto come prescritto dal medico.



AVVERTENZA

Il dispositivo è destinato al solo uso da parte di persone esperte con conoscenze adeguate in materia di procedure di aspirazione e uso di aspiratori. Per qualsiasi uso dell'aspiratore, mettersi sempre i guanti.

7.4 Modifica del livello di vuoto

1.

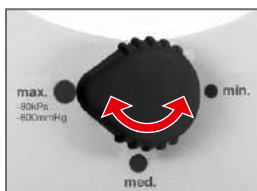

1.1 Impostare il regolatore del vuoto alla posizione desiderata.

7.5 Spegnimento dopo l'utilizzo

1.

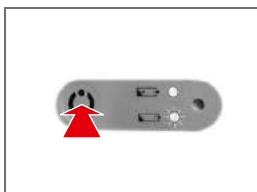

1.1 Premere il pulsante ON/OFF per spegnere l'aspiratore.

2. **Se l'aspiratore è collegato a una presa di rete a muro,**

scollegare la spina di alimentazione dalla presa;

oppure

Se l'aspiratore è collegato a una fonte di alimentazione a 12 VCC,

scollegare la spina a 12 VCC dalla fonte di alimentazione a 12 VCC.





3. Pulire e disinfettare l'aspiratore Clario Toni. Consultare il capitolo 16.

8 Svuotamento del contenitore



Suggerimento relativo alla sicurezza

Il contenitore deve essere svuotato ogni giorno o al più tardi quando il livello del fluido raggiunge i 550 ml e la valvola di troppo pieno arresta l'aspirazione nel contenitore.

1.  1.1 Premere il pulsante ON/OFF per spegnere l'aspiratore.
2.  2.1 Scollegare il tubicino monouso con fingertip dall'attacco di aspirazione.
2.2 Rimuovere il contenitore dall'aspiratore.
3.  3.1 Durante il trasporto, sigillare sempre il contenitore con i tappi.
4. Svuotare il contenitore e smaltire il tubicino con fingertip secondo le direttive locali e quelle della struttura.
5.  5.1 Collegare un contenitore pulito.
5.2 Collegare un nuovo tubicino monouso con fingertip all'attacco di aspirazione.
6. Accendere l'aspiratore e impostare il vuoto secondo la prescrizione del medico.

9 Sostituzione dei dischi della valvola

1. 1.1 Rimuovere il contenitore.



2. 2.1 Ruotare la camera di sicurezza a sinistra di 45°.
2.2 Rimuovere la camera di sicurezza estraendola dall'aspiratore.

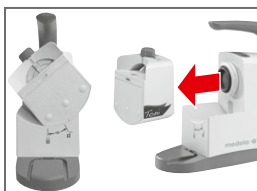

3. 3.1 Aprire la camera di sicurezza.



4. 4.1 Sostituire i dischi della valvola difettosi. Verificare che i nuovi dischi della valvola siano fissati correttamente.

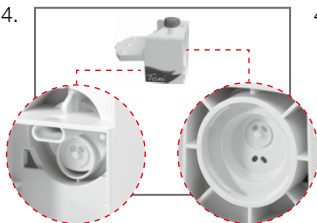

5. Fissare la camera di sicurezza all'aspiratore come descritto nel capitolo 6.3.

10 Sostituzione della batteria



AVVERTENZA

Prima di sostituire la batteria, spegnere l'aspiratore Clario Toni e scollegare la spina di alimentazione dell'aspiratore dalla presa di rete a muro.



Prima di questa operazione, estrarre la spina dalla presa di rete a muro.

1.  1.1 Aprire il coperchio del vano batteria sul fondo dell'aspiratore Clario Toni.
2.  2.1 Scollegare il cavo della batteria estraendo lo spinotto.
3. Rimuovere la batteria vecchia.
4. Inserire la nuova batteria.
5.  5.1 Collegare nuovamente il cavo della batteria inserendo lo spinotto.
6. Chiudere il coperchio del vano batteria. Verificare che il coperchio sia ben chiuso e che il cavo della batteria non sia schiacciato o strozzato.
7. Calibrare e testare la batteria (consultare i capitoli 11 / 12).

11 Dati e test della batteria



ATTENZIONE

Caricare la batteria solo quando l'indicatore di carica lampeggia lentamente.

Durata di pompaggio

Se la batteria è completamente carica, l'autonomia di funzionamento con vuoto massimo è circa > 50 minuti.

Tempo di carica (carica fino al 100%)

Circa 5 ore

Stato della batteria

non acceso	Batteria carica
acceso	– Batteria in carica – Aspiratore collegato alla rete elettrica
lampeggia lentamente	Batteria quasi scarica
lampeggia velocemente	Batteria guasta

Test della batteria

1. Accertarsi che la batteria sia completamente carica.
2. Estrarre la spina di alimentazione dalla presa di rete a muro.

3.

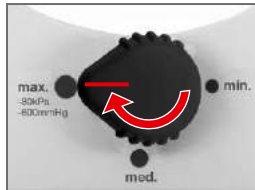

3.1 Impostare il regolatore del vuoto sulla posizione "max.".

4.

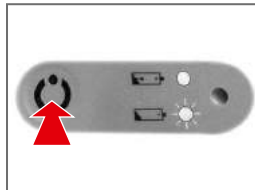

4.1 Accendere l'aspiratore Clario Toni. L'aspiratore inizia a funzionare.

5. Misurare il tempo fino all'arresto dell'aspiratore. La batteria è OK se l'autonomia è > 50minuti.

Se l'autonomia è < 50 minuti, ripetere il test o calibrare la batteria (vedere la pagina seguente).

12 Calibrazione della batteria



ATTENZIONE

Calibrare la batteria prima del primo utilizzo e dopo un tempo di immagazzinamento > 2 mesi. Se la calibrazione non ha esito positivo, sostituire la batteria.

Calibrazione della batteria NiMH

1. Accertarsi che la batteria sia completamente carica.
2. Estrarre la spina di alimentazione dalla presa di rete a muro.

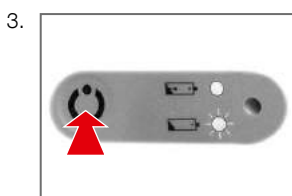

3.1 Accendere l'aspiratore Clario Toni. L'aspiratore inizia a funzionare.

4. Lasciare l'aspiratore in funzione finché la batteria non si esaurisce e l'aspiratore si arresta.
5. Collegare l'aspiratore Clario Toni a una presa di rete a muro. La batteria è in carica.
6. Attendere lo spegnimento dell'indicatore di carica.
7. Ripetere le operazioni da 1 a 6. L'aspiratore Clario Toni CA/CC è pronto all'uso.

Conservazione della batteria

Per mantenere al minimo l'autoscarica, conservare Clario Toni e le batterie di riserva rimosse a temperatura inferiore a 25 °C (77 °F). Ripetere il processo di calibrazione ogni 60-90 giorni.

13 Risoluzione guasti

Il motore non gira

Verificare che:

- l'aspiratore Clario Toni sia accesa;
- la tensione di rete sia corretta e la spina di alimentazione sia inserita correttamente nella presa di rete a muro;
- la batteria interna sia carica.

L'aspiratore è troppo rumoroso

Verificare la posizione e la tenuta dei dischi della valvola all'interno della camera di sicurezza.

Vuoto insufficiente

Verificare che:

- il regolatore del vuoto sia impostato correttamente;
- i tubi non siano difettosi o rotti; se necessario, sostituire;
- tutti i collegamenti siano ben serrati;
- il contenitore di aspirazione e il coperchio non presentino rotture, zone fragili, scoloriture; se necessario, sostituire;
- la tenuta dei dischi della valvola nella camera di sicurezza sia salda;
- la membrana sia pulita e non presenti lacerazioni.

Durata del funzionamento a batteria insufficiente

Calibrare la batteria. Consultare il capitolo 12.

Nessun LED acceso

La batteria è completamente carica.

LED acceso

- La batteria è in carica.
- L'aspiratore è collegato alla rete elettrica.

Il LED lampeggia lentamente

La batteria è quasi scarica. L'alimentazione della batteria è sufficiente per circa 10 minuti di pompaggio.

Il LED lampeggia velocemente

La batteria è guasta. Per la sostituzione della batteria difettosa consultare il capitolo 10.

14 Garanzia e manutenzione

Garanzia

Medela AG garantisce che il dispositivo sia esente da difetti di materiali e di fabbricazione per un periodo di 2 anni (6 mesi per la batteria) dalla data di consegna. Il materiale difettoso sarà sostituito gratuitamente durante tale periodo, purché il difetto non sia originato da abuso o da utilizzo scorretto. Quanto sopra non si applica alle parti soggette a usura derivante dall'utilizzo. Per assicurare la conformità alla presente garanzia e per ottenere un servizio ottimale dai prodotti Medela, si raccomanda di utilizzare esclusivamente accessori Medela con i nostri dispositivi. In nessun caso Medela AG sarà responsabile di richieste che esulano dall'ambito della garanzia descritta, inclusa la responsabilità per danni indiretti ecc. Il diritto alla sostituzione delle parti difettose non sarà riconosciuto da Medela ove siano stati eseguiti lavori sull'aspiratore da parte di personale non autorizzato. La presente garanzia è condizionata dalla restituzione del dispositivo al centro di assistenza Medela.

Manutenzione

I servizi di assistenza tecnica devono essere effettuati esclusivamente da centri autorizzati da Medela. Il manuale di assistenza di Medela è disponibile su richiesta.

15 Smaltimento

L'aspiratore Clario Toni comprende metalli e plastiche e deve essere smaltito in conformità con le direttive europee 2011/65/CE e 2012/19/CE. Le disposizioni supplementari locali devono essere rispettate. Per le versioni CA/CC, smaltire separatamente i componenti elettronici e la batteria, in conformità con le disposizioni locali.

Accertarsi di smaltire l'aspiratore Clario Toni e i relativi accessori in conformità con le direttive locali di smaltimento.



Informazioni per l'utente in merito allo smaltimento di apparecchiature elettriche ed elettroniche

Questo simbolo indica che le apparecchiature elettriche ed elettroniche non devono essere smaltite come normali rifiuti domestici. Il corretto smaltimento di questo dispositivo protegge l'ambiente e la salute delle persone ed evita che possano essere danneggiati. Per ulteriori informazioni in merito allo smaltimento, contattare il produttore o il fornitore di assistenza sanitaria locale. Questo simbolo è valido solo per l'Unione Europea. Rispettare leggi e regolamenti rilevanti in vigore nel proprio Paese per lo smaltimento di apparecchiature elettriche ed elettroniche.

16 Linee guida per la pulizia



AVVERTENZA

Dopo ogni utilizzo, le parti che sono state a contatto con le secrezioni aspirate devono essere pulite, disinfettate, sterilizzate o smaltite **come indicato nella tabella alla pagina seguente**.



Prima di pulire il dispositivo, estrarre la spina dalla presa di rete a muro.

Note generali

- Le seguenti sono soltanto raccomandazioni generali, che possono essere modificate individualmente sulla base delle direttive specifiche, delle pratiche di pulizia e delle politiche dell'ospedale.
- Per informazioni dettagliate, vedere le istruzioni per la pulizia di Medela (codice prodotto n. 200.2391).
- Indossare guanti protettivi per la pulizia/disinfezione.
- Smaltire i fluidi, quali sangue e secrezioni corporee, e le parti da essi contaminate in conformità con le direttive interne dell'ospedale.

Detergenti per superfici raccomandati da Medela per l'involucro dell'aspiratore

- **CaviWipes**, Metrex Research, www.sybrondental.com
- **mikrozyd® AF wipes**, Schülke&Mayr GmbH, www.schuelke.com

Acqua

Usare solo acqua della qualità più pura per la pulizia. La durezza dell'acqua è un fattore importante, in quanto i depositi residui sui prodotti medicali possono non essere decontaminati correttamente. Utilizzare acqua deionizzata per ridurre l'insorgenza di tale problema. L'acqua per il risciacquo finale deve essere priva di batteri e non contenere endotossine.

Lavatrici/disinfettatrici

Possono essere utilizzate per disinfettare componenti, come indicato nella tabella alla pagina seguente. Un risciacquo in acqua calda (temperatura massima 100 °C) può consentire un livello di disinfezione da medio a elevato. Per assicurare una pulizia efficiente, ogni sezione delle parti componenti deve essere accessibile. Si raccomanda l'utilizzo di una macchina per lavaggio/disinfettatrice approvata dal Robert Koch Institute e conforme alla norma ISO 15883. La temperatura consigliata per i dispositivi medicali non critici (cioè quelli che vengono in contatto soltanto con cute non lesionata) è 90 °C per 1 minuto. La durata deve essere prolungata a 5 minuti per tutti i dispositivi medicali considerati critici.



Prodotti monouso

Si tratta di prodotti monouso non destinati alla rigenerazione. Tale trattamento potrebbe causare la perdita di caratteristiche meccaniche, chimiche e/o biologiche. Il riuso può causare infezioni crociate.

Contenitore, camera di sicurezza	Involucro dell'aspiratore Cavo di rete	
x	x	<p>1. Smontaggio Separare tutti i singoli componenti prima della pulizia, della disinfezione e della sterilizzazione.</p>
x		<p>2. Pulizia del contenitore e della camera di sicurezza Pulire i componenti in acqua calda (60–70 °C) contenente esclusivamente un detergente con un intervallo di pH tra 6,0 e 8,0, al fine di evitare di danneggiare gli strumenti e i contenitori. I detersivi agli enzimi sono utili per rimuovere i materiali organici, come ad esempio il sangue. I detersivi devono essere usati secondo i livelli di concentrazione raccomandati dai rispettivi produttori. Alcuni detersivi alcalini sono studiati in modo da essere sicuri per la rigenerazione di dispositivi medicali. I produttori di tali detersivi devono fornire informazioni in merito agli specifici materiali che possono essere danneggiati dai loro detersivi. Immergere a fondo tutti i componenti in acqua saponata calda o in un detergente agli enzimi, per 1–5 minuti.</p> <p>1. Rimuovere la sporcizia visibile con un utensile per pulizia: spazzole per uso generico come nappape o panni non abrasivi. Le spazzole e i nappape devono aderire bene alle pareti ma poter essere comunque mossi con facilità nell'area da pulire. Sciacquare in abbondante acqua pulita. Lasciare asciugare.</p> <p>2. Verificare la presenza di sporcizia visibile sugli strumenti e ripetere le operazioni, ove necessario.</p>
	x	<p>3. Pulizia dell'involucro dell'aspiratore e del cavo di alimentazione Pulire con il detergente menzionato in precedenza. Asciugare con un panno pulito.</p>
x		<p>4. Disinfezione Immergere a temperatura ambiente per 30 minuti in una soluzione disinfettante/detergente (A). Dopo il tempo di reazione, sciacquare con acqua i residui di soluzione dai singoli componenti e sciacquare i tubi. Sciacquare per almeno 2 minuti con la soluzione detergente (B).</p> <p>(A) soluzione fluida disinfettante priva di aldeidi con effetto detergente, da usare come bagno a immersione, battericida, fungicida, virucida limitato, con buona compatibilità con materiali come acciaio inossidabile, materiali non ferrosi e plastiche, compreso il silicone, leggermente alcalica, ad esempio 2% neodisher® Septo MEDsolution.</p> <p>(B) soluzione fluida detergente agli enzimi, pH neutro, per il trattamento a macchina o manuale di strumenti, con ottima compatibilità con materiali come acciaio inossidabile, materiali non ferrosi e plastiche, compreso il silicone.</p> <p>oppure utilizzare una lavatrice/disinfettatrice, o una lavastoviglie.</p>
x		<p>5. Conservazione dei componenti Dopo la disinfezione, riporre i componenti su un panno pulito e asciutto.</p>

17 Panoramica degli accessori



AVVERTENZA

Clario Toni è stato testato in combinazione con gli accessori elencati di seguito. Per un funzionamento corretto e sicuro, usare Clario Toni soltanto con tali accessori. Ulteriori informazioni sono disponibili nel foglio di istruzioni dei singoli accessori.

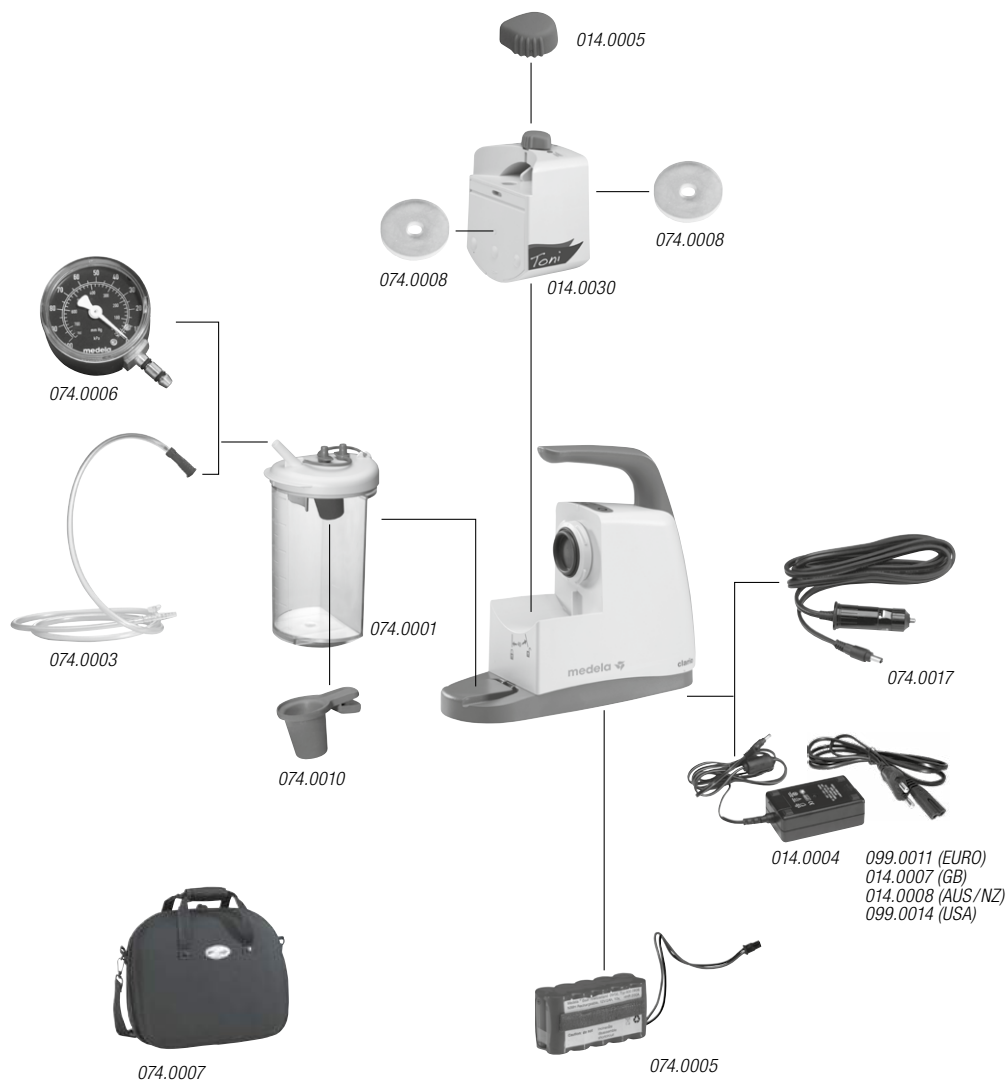

18 Legenda accessori



Suggerimento relativo alla sicurezza

Se l'aspiratore è utilizzato insieme a parti applicate non di produzione Medela, tali parti devono:

- presentare il marchio CE e (ove necessario) la registrazione locale;
- consentire il collegamento agli accessori Medela in sicurezza senza effetti sul funzionamento dell'aspiratore.

Nota: se parti non di produzione Medela sono collegate a parti Medela, l'utente si assume la responsabilità dell'intero sistema.

REF

014.0030	Camera di sicurezza
014.0005	Regolatore del vuoto
074.0008	Dischi della valvola (10 pz.)
074.0001	Set di contenitori
074.0010	Valvola di troppo pieno (10 pz.)
074.0003	Tubicino monouso con fingertip
074.0005	Batteria ricaricabile
014.0004	Adattatore di alimentazione
099.0011	Cavo di alimentazione (EURO)
099.0014	Cavo di alimentazione (USA)
014.0007	Cavo di alimentazione (GB)
074.0007	Borsa per il trasporto
074.0017	Cavo di collegamento auto per 12 VCC
074.0006	Manometro per vuoto

19 Segni e simboli



Questo simbolo indica la conformità ai requisiti fondamentali della Direttiva del Consiglio 93/42/CEE del 14 giugno 1993 relativa ai dispositivi medici.



Questo simbolo indica la classe dell'aspiratore.



Questo simbolo indica un dispositivo di classe II.



Questo simbolo indica che il dispositivo non deve essere usato dopo la fine del mese e dell'anno indicati.



Questo simbolo indica la conformità ai requisiti di sicurezza supplementari di USA e Canada per le apparecchiature elettromedicali.



Questo simbolo indica la protezione contro gli effetti nocivi dovuti all'ingresso di oggetti estranei solidi e contro gli effetti nocivi dovuti all'ingresso di acqua.



Questo simbolo indica un dispositivo monouso. Non riutilizzare il dispositivo.



Questo simbolo indica il codice nel catalogo del produttore.



Questo simbolo indica le specifiche legali dell'aspiratore.



Questo simbolo indica un componente applicato di tipo BF.



Questo simbolo indica il numero di serie del produttore.



Questo simbolo indica di seguire le istruzioni per l'uso.



Questo simbolo indica un dispositivo NON IDONEO ALLA RISONANZA MAGNETICA.



Questo simbolo indica il codice di lotto del produttore.



Questo simbolo indica di consultare le istruzioni per l'uso.



Questo simbolo indica che possono verificarsi interferenze nelle vicinanze del dispositivo contrassegnato con il simbolo stesso.



Questo simbolo indica che il dispositivo è sterilizzato utilizzando ossido di etilene.



Questo simbolo indica un messaggio di ATTENZIONE o di AVVERTENZA associato al dispositivo.



Questo simbolo indica il produttore.



Questo simbolo indica i limiti di temperatura per funzionamento, trasporto e conservazione.



Questo simbolo indica un suggerimento relativo alla sicurezza.



Questo simbolo indica la data di produzione (quattro cifre per l'anno e due cifre per il mese).



Questo simbolo indica i limiti di umidità per funzionamento, trasporto e conservazione.



Questo simbolo indica i limiti di pressione atmosferica per funzionamento, trasporto e conservazione.



Questo simbolo indica di non utilizzare il dispositivo se la confezione è danneggiata.



Questo simbolo indica il numero n di elementi per cui il contenuto è sufficiente.



Questo simbolo indica di non smaltire il dispositivo nei rifiuti urbani indifferenziati (solo per UE).



Questo simbolo indica che il materiale è oggetto di un processo di recupero/riciclaggio.



Questo simbolo indica una confezione in cartone.



Questo simbolo indica che il dispositivo non deve essere esposto alla luce solare.



Questo simbolo indica che il dispositivo è fragile e deve essere maneggiato con attenzione.



Questo simbolo indica di mantenere il dispositivo asciutto.



Questo simbolo indica il livello massimo di vuoto dell'aspiratore.



Questo simbolo indica i livelli di portata dell'aspiratore.



Questo simbolo indica le specifiche elettriche dell'aspiratore.



Questo simbolo indica la corrente alternata.



Questo simbolo indica la corrente continua.



Questo simbolo indica il peso dell'aspiratore.



Questo simbolo indica le dimensioni (A x L x P) dell'aspiratore.



Questo simbolo indica un dispositivo soggetto a prescrizione medica. **ATTENZIONE:** la legge federale statunitense limita la vendita di questo dispositivo ai medici o su loro prescrizione (soltanto per gli USA).

pcs Questo simbolo indica il numero di pezzi.

20 Dati tecnici



vuoto minimo, - 70 mmHg / - 9 kPa (+/- 20 mmHg / +/- 2,6 kPa)
vuoto medio, - 115 mmHg / - 15 kPa (+/- 30 mmHg / +/- 4 kPa)
vuoto massimo, - 600 mmHg / - 80 kPa (- 90 mmHg / - 12 kPa)

Calcolato a 0 m, pressione atmosferica: 1013 hPa
Nota bene: i livelli di vuoto possono variare in funzione della località (altitudine sul livello del mare, pressione atmosferica e temperatura).



Portata bassa: 15 l/min. (+/- 10%)



2,0 kg / 4,4 lbs
Senza contenitore



100-240 V, 50-60 Hz
12 V, 3,4 A, NiMH
Adattatore di alimentazione
UE48-120340SPA1



ISO 13485
CEE 93/42 Classe IIa



A x L x P
223x255x95 mm

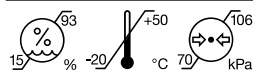

Trasporto/conservazione



Trasporto/conservazione
Batteria ricaricabile

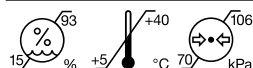

Funzionamento



IP21

21 Documentazione tecnica



AVVERTENZA

Non utilizzare accessori diversi da quelli specificati o venduti dal produttore come parti di ricambio per i componenti interni; ciò potrebbe causare l'aumento delle emissioni o la riduzione dell'immunità dell'aspiratore Clario Toni.

Le apparecchiature chirurgiche ad alta frequenza, reti radio o apparecchiature simili possono influire sul funzionamento del dispositivo e non devono essere utilizzate in combinazione con Clario Toni.

EMC

Clario Toni è stato sottoposto a test di compatibilità elettromagnetica conformemente ai requisiti dello standard IEC 60601-1-2:2007 e IEC 60601-1-2:2014 4a Edizione secondo le clausole 7 e 8.9. Clario Toni è un dispositivo medico che richiede speciali misure di sicurezza e deve essere installato e messo in servizio in conformità con le informazioni di compatibilità elettromagnetica allegate.

Vedere inoltre pagg. 326–329.

Inhoudsopgave

Hartelijk gefeliciteerd	132
1 Waarschuwingen en veiligheidsinstructies	133
Veiligheidsinstructies	135
2 Stroomvoorziening en werking op accu	136
Accu bijna leeg	136
Accu leeg.....	136
3 Beschrijving	137
Inleiding	137
Beoogd gebruik / indicaties.....	137
Contra-indicaties	137
Beoogde gebruiker.....	137
Verwachte patiëntenpopulatie	137
Belangrijke opmerking.....	137
4 Overzicht.....	138
Definitie van vacuüm.....	138
Uitvoeringen van de pomp	138
Hoofdonderdelen van de pomp.....	138
Positie van het membraan.....	139
Afsluitkleppen in de veiligheidskamer.....	139
Bedieningselementen en accustatus.....	139
5 Installatie.....	140
Controle basislevering	140
6 Voorbereidingen voor gebruik.....	141
Controles voor het gebruik	141
Het reservoir in elkaar zetten.....	141
De veiligheidskamer in elkaar zetten	142
Het reservoir aan de pomp bevestigen	142
7 Gebruikshandleiding.....	143
Sluit de Clario Toni op de netstroom aan	143
Functiecontrole met water	144
Alternatief: functiecontrole met de optionele vacuümmeter	145
Vacuümniveau wijzigen.....	146
Uitzetten na gebruik	146
8 Het reservoir legen.....	147
9 De afsluitkleppen vervangen.....	148

10 De accu vervangen	149
11 Accu-informatie en testen	150
Pompduur.....	150
Laadtijd (tot 100% geladen).....	150
Accustatus.....	150
De oplaadbare accu testen	150
12 Accu kalibreren	151
De NiMH accu kalibreren.....	151
Opslag van de accu.....	151
13 Storingen opheffen	152
Motor loopt niet	152
De pomp maakt teveel geluid.....	152
Ontoereikend vacuüm	152
Levensduur accu onvoldoende	152
Ledlampje brandt niet.....	152
Ledlampje brandt	152
Ledlampje knippert langzaam	152
Ledlampje knippert snel	152
14 Garantie en service	153
Garantie.....	153
Service.....	153
15 Afvalverwijdering	153
16 Richtlijnen voor het reinigen	154
Algemene opmerkingen	154
Door Medela aanbevolen oppervlaktereinigingsmiddelen voor de pompbehuizing	154
Water	154
Machines voor reiniging / desinfectie	154
Producten voor eenmalig gebruik.....	154
17 Overzicht accessoires	156
18 Legenda accessoires	157
19 Pictogrammen en symbolen	158
20 Technische specificaties	160
21 Technische documentatie	161
Technische documentatie/EMC	326



Hartelijk gefeliciteerd

Door te kiezen voor de Clario Toni hebt u de beschikking over een kwalitatief hoogwaardige zuigpomp die uitsluitend op voorschrift van een arts aan uw behoeften aangepast kan worden. Dit product is gemakkelijk te gebruiken en schoon te maken en biedt optimale bescherming tegen overlopen. Het membraansysteem werkt met een elektrische motor. U kunt de zuigkracht met de 3 vacuüminstellingen op het gewenste niveau instellen. Zoals alle vacuümpompen van Medela, biedt ook deze pomp een betrouwbaar en eenvoudig in te stellen vacuüm. Daarnaast biedt de pomp veel gebruikersgemak, is hij eenvoudig te reinigen en voorzien van extra veiligheidsfuncties. Neem contact met ons op – wij adviseren u graag.

1 Waarschuwingen en veiligheidsinstructies



WAARSCHUWINGEN

Verwijst naar een potentieel gevaarlijke situatie, die zonder passende tegenmaatregelen tot ernstige verwondingen of levensgevaar kan leiden.



ATTENTIE

Verwijst naar een potentieel gevaarlijke situatie, die zonder tegenmaatregelen tot lichte of matige verwondingen kan leiden.



Veiligheidstip

Verwijst naar nuttige informatie over veilig gebruik van het apparaat.

De Clario Toni is uitsluitend goedgekeurd voor de in deze gebruiksaanwijzing beschreven toepassingen. Medela kan het veilig functioneren van het systeem slechts garanderen wanneer de Clario Toni wordt gebruikt in combinatie met originele Medela-accessoires. Zie hoofdstuk 17/18.

Lees deze gebruiksinstructies en waarschuwingen voordat u het apparaat in gebruik neemt en volg ze strikt op. Bewaar deze gebruiksaanwijzing bij het apparaat zodat u deze later kunt raadplegen.

Let op, deze gebruiksaanwijzing is een algemene handleiding voor het gebruik van dit product. Medische aangelegenheden moeten door een arts worden behandeld. Medela acht zich slechts verantwoordelijk voor gevolgen op het vlak van de BASISVEILIGHEID, betrouwbaarheid en de prestaties van de Clario Toni mits het apparaat conform deze gebruiksaanwijzing wordt bediend.

LET OP: Volgens de federale wetgeving in de VS is de verkoop van dit apparaat, of de opdracht daartoe, voorbehouden aan een arts.

Onder voorbehoud van wijzigingen.



WAARSCHUWINGEN

- Uitsluitend voor gebruik door medisch getraind personeel, dat adequaat is opgeleid inzake afzuigprocedures en het gebruik van aspiratietoestellen.
- Voor patiënten bij wie uitvallen van het apparaat tot een kritieke situatie kan leiden (bv. patiënten met acute ademnood of veel slijm), moet altijd een reserveapparaat beschikbaar zijn.
- Het apparaat mag niet worden gebruikt voor het opzuigen van explosieve, licht ontvlambare of corrosieve vloeistoffen.
- De verbindingsslang die met het apparaat wordt meegeleverd mag nooit in direct contact komen met het afzuiggebied. Altijd een steriele vacuümkatheter gebruiken (infectiegevaar).
- Alvorens het apparaat te reinigen altijd eerst de stekker uit het stopcontact trekken.
- Het aanbrengen van aanpassingen aan deze apparatuur is niet toegestaan.
- Dit apparaat niet aansluiten op een passieve drainageslang.
- Lees deze gebruiksaanwijzing door en informeer uzelf over de risico's en contra-indicaties voordat u de Clario Toni gebruikt. Het niet doorlezen of niet opvolgen van alle instructies in deze gebruiksaanwijzing voordat u het apparaat in gebruik neemt, kan leiden tot ernstig letsel of overlijden van de patiënt.
- Gebruik Clario Toni niet in een MRI-omgeving (Magnetic Resonance Imaging).
- De voeding van het apparaat kan beschadigd raken door elektrostatische ontlading (ESD) aan de DC-poort van 15 kV.



ATTENTIE

- Onjuist gebruik kan bij de patiënt pijn en letsel veroorzaken.
- Gebruik nooit steriele accessoires waarvan de steriele verpakking beschadigd is.
- Draadloze communicatieapparatuur zoals draadloze apparaten van een thuisnetwerk, mobiele telefoons, draadloze telefoons en bijbehorende basisstations en walkietalkies kunnen de werking van de Clario Toni beïnvloeden en dienen ten minste op 30 cm afstand te worden gehouden.
- Draagbare en mobiele RF-communicatieapparatuur kan medische apparatuur beïnvloeden.



Veiligheidstip

- Wat betreft de veiligheidstesten wordt aangenomen dat het apparaat gedurende de levensduur conform de onderhoudshandleiding wordt onderhouden en gerepareerd. De Clario Toni is een apparaat van veiligheidsklasse II (EN IEC 60601-1, A1, A2:1995). Derhalve zijn de veiligheidstesten beperkt tot een visuele inspectie van de behuizing en het elektriciteitsnoer. Deze test moet voor elk gebruik worden uitgevoerd.
- De lekstroom naar patiënten testen: raadpleeg de onderhoudshandleiding voor nadere informatie.
- De bescherming van de Clario Toni tegen de gevolgen van een ontlading van een defibrillator is afhankelijk van het gebruik van de juiste kabels.
- Alleen door de stekker uit het stopcontact te trekken, is het apparaat gegarandeerd losgekoppeld van de stroomvoorziening.
- Voordat u het apparaat aansluit, dient u na te gaan of de aansluitwaarde die op het typeplaatje vermeld staat, overeenkomt met de lokale netspanning.

Veiligheidsinstructies

- De Medela Clario Toni is een medisch apparaat, waarvoor speciale veiligheidsmaatregelen betreffende EMC vereist zijn. De apparatuur moet worden geïnstalleerd en in gebruik worden genomen conform de bijgevoegde EMC-voorschriften.
- In elk van de volgende gevallen mag het apparaat niet in bedrijf genomen worden en moet het door de technische dienst gerepareerd worden:
 - als het elektriciteitssnoer of de stekker beschadigd is;
 - als het apparaat niet perfect werkt;
 - als het apparaat beschadigd is;
 - als het apparaat duidelijk zichtbare veiligheidsgebreken vertoont.
- Houd het elektriciteitssnoer uit de buurt van warmtebronnen.
- De stekker en de aan/uit-schakelaar mogen niet met vocht in aanraking komen.
- Trek nooit de stekker uit het stopcontact door aan het elektriciteitssnoer te trekken!
- Ingeschakeld apparaat nooit zonder toezicht laten.
- Tijdens het gebruik moet de pomp rechtop staan.
- Hang het elektriciteitssnoer nooit om uw nek.
- Het apparaat nooit gebruiken bij een hoge temperatuur in de ruimte, tijdens het baden of douchen, als u zeer moe bent of in een explosiegevaarlijke omgeving.
- Dompel het apparaat nooit onder in water of in andere vloeistoffen.
- Let er bij het gebruik van wegwerp- en steriele producten op dat deze niet voor hergebruik geschikt zijn. Hergebruik kan leiden tot verlies van mechanische, chemische en/of biologische eigenschappen. Hergebruik kan kruisbesmetting veroorzaken.
- Neem contact op met uw lokale Medela-vertegenwoordiger voor hulp bij het gebruik van de producten.
- Draag handschoenen voor alle verrichtingen.

Bewaar deze gebruiksaanwijzing voor latere raadpleging.

2 Stroomvoorziening en werking op accu

De Clario Toni is een vacuümpomp die op netstroom en op accu werkt. Voordat u het apparaat aansluit, dient u na te gaan of de aansluitwaarde die op het typeplaatje vermeld staat, overeenkomt met de lokale netspanning. Bij gebruik in overeenstemming met deze handleiding bedraagt de accutijd van het Clario Toni AC / DC-model maximaal 50 minuten voordat opladen nodig is. Als de Clario Toni AC / DC niet in gebruik is, moet de accu om de 2–3 maanden gekalibreerd worden.

Accu bijna leeg

Tijdens de werking op accu geeft een langzaam knipperen van het ledlampje aan dat de accu bijna leeg is. De Clario Toni blijft nog korte tijd (~ 10 minuten) functioneren, maar de accu moet zo spoedig mogelijk worden opgeladen.

Accu leeg

Zodra de accu leeg is, komt de pomp tot stilstand. De pomp kan niet meer naar behoren functioneren. De accu moet worden opgeladen of vervangen.

3 Beschrijving

Inleiding

De Clario Toni is een hoogwaardige vacuümpomp. Hij werkt op het beproefde membraansysteem. De ideale combinatie van gebruiks- en schoonmaakgemak en veiligheidsfuncties garandeert een optimale werking. Gebruik het apparaat volgens de instructies van uw arts en nadat u instructies van geschoolde medische specialisten hebt gekregen.

Beoogd gebruik / indicaties

De Clario Toni-vacuümpompen zijn bedoeld om secreties, lichaamsvloeistoffen en vreemde voorwerpen uit de luchtwegen van de patiënt of het beademingsapparaat in het nasale, faryngale en tracheale gebied bij pediatrische en volwassen patiënten af te zuigen en te verwijderen. Deze vacuümpomp is geschikt voor gebruik thuis, in het ziekenhuis, in de auto of buiten.

Indicaties

De Clario Toni-vacuümpomp wordt voorgeschreven om de luchtwegen uit te zuigen, hetzij door de neus, de mond of een tracheotomieslang.

Contra-indicaties

Het apparaat is niet geschikt voor langdurig continu gebruik.

Beoogde gebruiker

De Clario Toni mag alleen worden gebruikt door goed geïnstrueerde gebruikers. Deze personen mogen niet hardhorend of doof zijn en moeten voldoende gezichtsvermogen hebben. De instructie moet minstens eenmaal per jaar worden herhaald.

Verwachte patiëntenpopulatie

De Clario Toni is alleen bedoeld voor gebruik bij patiënten die voldoen aan de therapeutische indicaties.

Belangrijke opmerking

Het volgen van de juiste chirurgische procedures en technieken is de verantwoordelijkheid van de arts. De arts dient de juistheid van de behandeling te beoordelen op basis van zijn/haar eigen kennis en ervaring.

4 Overzicht

Definitie van vacuüm

Voor medische aspiratieapparatuur wordt het vacuüm gewoonlijk weergegeven als het verschil (in absolute cijfers) tussen de absolute druk en de atmosferische druk of als negatieve waarde in kilopascal (kPa). In dit document verwijst de waarde van -10 kPa bijvoorbeeld altijd naar een negatief drukbereik in kPa ten opzichte van de atmosferische omgevingsdruk (conform EN ISO 10079:1999).

Uitvoeringen van de pomp



Clario Toni AC/DC

Hoofdonderdelen van de pomp



Positie van het membraan



Afsluitkleppen in de veiligheidskamer

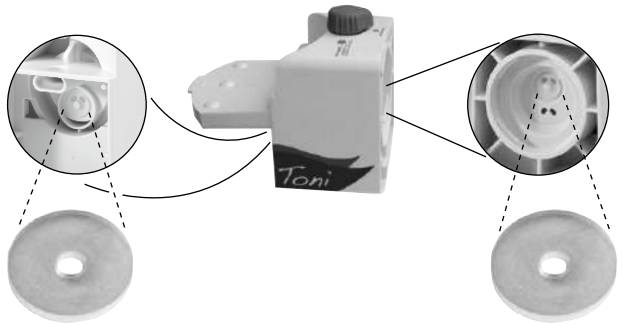

Bedieningselementen en accustatus



Vacuümregelaar

Aan/uit-schakelaar

Ledlamp oplaadbare accu

brandt niet

De accu is volledig opgeladen

brandt

- De accu wordt opgeladen
- Stekker van de pomp is in het stopcontact gestoken

knippert langzaam

Accu is bijna leeg

knippert snel

Accu is defect

5 Installatie

Controle basislevering

Controleer of het geleverde pakket van de Clario Toni compleet en in goede toestand is.



Clario Toni-versies

REF Clario Toni AC/DC 014.00XX
Clario Toni Deluxe 014.00XX



Wegwerp vacuümslang met vingertop-regeling, steriel

REF 074.0003



Spanningsadapter

REF 014.0004

Elektriciteitsnoer

099.0011 (Europa)

014.0007 (VK)

014.0008 (AUS/NZ)

099.0014 (VS)



Gebruiksaanwijzing

REF 200.8400



WAARSCHUWINGEN

De verbindingsslang die met het apparaat wordt meegeleverd, mag nooit in direct contact komen met het afzuiggebied. Altijd een steriele vacuümkatheter gebruiken (infectiegevaar).

6 Voorbereidingen voor gebruik



WAARSCHUWINGEN

Uitsluitend voor gebruik door medisch getraind personeel dat adequaat is opgeleid inzake afzuigprocedures en het gebruik van aspiratietoestellen. Draag handschoenen voor alle verrichtingen.



ATTENTIE

- De Clario Toni moet tijdens het gebruik steeds rechtop blijven.
- Voor het gebruik controleren of de verpakking van steriele accessoires niet beschadigd is.
- Niet-steriele en herbruikbare accessoires reinigen, desinfecteren en/of steriliseren conform de Medela-reinigingshandleiding (productcode 200.2391).

6.1 Controles voor het gebruik

- Controleer het Clario Toni-systeem voor gebruik op beschadiging van het elektriciteits snoer of de stekker, op zichtbare schade of veiligheidsdefecten en op het correct functioneren van het apparaat.
- Controleer het geleverde pakket met de Clario Toni op volledigheid en beschadiging.
- Zorg ervoor dat de accu gekalibreerd is in overeenstemming met hoofdstuk 12.
- Controleer alle accessoires voor het gebruik:
 - Reservoir en deksel controleren op scheuren, broze plekken of beschadigingen. Indien nodig vervangen.
 - Slangen controleren op scheuren, broze plekken en of de aansluitstukken goed vastzitten. Indien nodig vervangen.

6.2 Het reservoir in elkaar zetten



1.1 Bevestig de vlotter in het reservoir.



2.1 Bevestig het deksel op het reservoir. Let daarbij op de markeringen aan de voorkant van het reservoir en het deksel.

6.3 De veiligheidskamer in elkaar zetten

1.

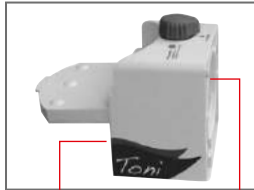

1.1 Open het deksel van de veiligheidskamer.

2.

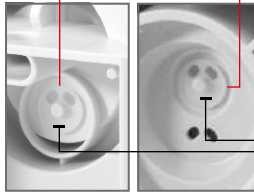

2.1 Zorg ervoor dat beide afsluitkleppen (silicone schijven) aan de veiligheidskamer worden bevestigd. Zie hoofdstuk 4.

3.



3.1 Zorg ervoor dat het deksel van de veiligheidskamer goed gesloten is.

4.

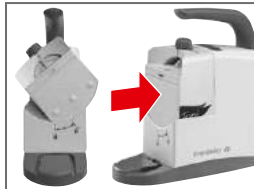

4.1 Pak de veiligheidskamer op, kantel hem 45° naar links en plaats hem in de motoreenheid.

4.2 Draai de veiligheidskamer rechtop totdat u een klik hoort.

6.4 Het reservoir aan de pomp bevestigen

1.



1.1 Bevestig het reservoir aan de pomp. Druk krachtig aan.

2.



2.1 Bevestig de wegwerpslang met vingertopregeling aan de afzuigpoort.

7 Gebruikshandleiding



ATTENTIE

De Clario Toni moet zodanig worden geplaatst dat deze eenvoudig van de netstroom kan worden losgekoppeld. Kalibreer de accu voor het eerste gebruik.



WAARSCHUWINGEN

Uitsluitend voor gebruik door medisch getraind personeel dat adequaat is opgeleid inzake afzuigprocedures en het gebruik van aspiratietoestellen. Draag handschoenen voor alle verrichtingen.

7.1 Sluit de Clario Toni op de netstroom aan

1. Controleer de pomp voor gebruik volgens de instructies in hoofdstuk 6.1.

2. **Alle modellen: als de pomp is aangesloten op een vaste wand-contactdoos.**

Steek de stekker van het elektriciteitsnoer in een vaste wandcontactdoos.

of

Als de pomp werkt op een 12 V DC stroombron:

Sluit de optionele 12 V DC-verbindingkabel aan op de pomp en op de 12 V DC stroombron.

of

Als de pomp werkt op de accu:

Er is geen verbinding met een stroombron nodig. Zorg ervoor dat de accu gedurende vijf uur opgeladen is.



7.2 Functiecontrole met water

1.

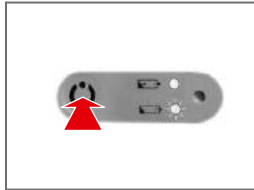

1.1 Druk de aan/uit-schakelaar in om de pomp aan te zetten.

2.

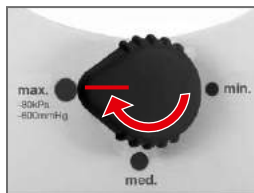

2.1 Zet de vacuümregelaar op positie "max.".

3.

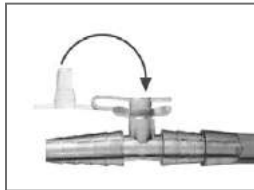

3.1 Bevestig de slang met vingertopregeling.
Zie hoofdstuk 6.4, stap 2.1.
3.2 Sluit de vingertoppoort aan.

4.

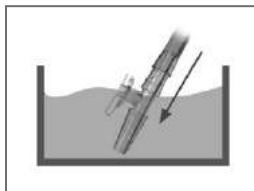

4.1 Plaats vingertop in water en controleer of er zuigwerking is.

5. Als er zuigwerking is, ga dan verder met stap 6. Zo niet, raadpleeg hoofdstuk 13.

6. Gebruik de katheter en stel vacuüm in zoals door de arts voorgeschreven.

7.3 Alternatief: functiecontrole met de optionele vacuümmeter



1.1 Bevestig de optionele manometer aan de zuigpoort.

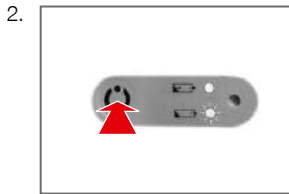

2.1 Druk de aan/uit-schakelaar in om de pomp aan te zetten.

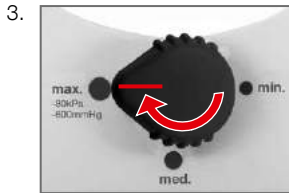

3.1 Zet de vacuümregelaar op positie "max.".

Hoogte boven zeeniveau:	Max. vacuüm:
+ 2000 m	- 63 kPa - 471 mmHg
+ 1000 m	- 71 kPa - 532 mmHg
+ 500 m	- 76 kPa - 566 mmHg
0 m	- 80 kPa - 600 mmHg

(Tolerantie: - 15%)



4.1 Vergelijk het vacuüm met de waarden in de tabel links.

5. Als de vacuüminstelling correct is, ga dan verder met stap 6. Zo niet, raadpleeg hoofdstuk 13.

6. Bevestig de slang met vingertopregeling.

7. Gebruik de katheter en stel vacuüm in zoals door de arts voorgeschreven.



WAARSCHUWINGEN

Uitsluitend voor gebruik door medisch getraind personeel dat adequaat is opgeleid inzake afzuigprocedures en het gebruik van aspiratietoestellen. Draag handschoenen voor alle verrichtingen.

7.4 Vacuümniveau wijzigen

1.

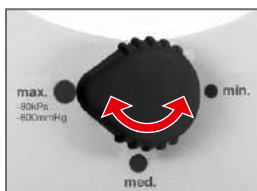

1.1 Zet de vacuümregelaar op de gewenste positie.

7.5 Uitzetten na gebruik

1.

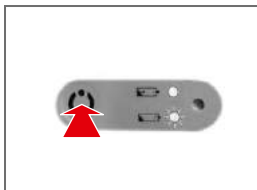

1.1 Bedien de aan/uitschakelaar om de pomp uit te schakelen.

2. **Als de pomp is aangesloten op een vaste wandcontactdoos:**

Haal de stekker uit het stopcontact om de pomp los te koppelen van de netstroom.

of

Als de pomp is aangesloten op een 12 V DC stroombron:

Haal de 12 V DC-stekker uit de 12 V DC-stroombron.



3. Reinig en desinfecteer de Clario Toni. Zie hoofdstuk 16.

8 Het reservoir legen

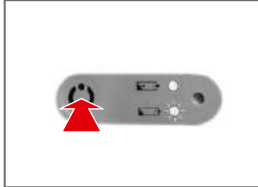

Veiligheidstip

Het reservoir behoort dagelijks te worden geleegd, of uiterlijk als het vloeistofniveau 550 ml bereikt en de vlotter stopt met inzuigen in het reservoir.

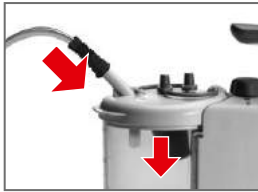
1.  1.1 Bedien de aan/uit-schakelaar om de pomp uit te schakelen.
2.  2.1 Ontkoppel de wegwerp vingertopslang van de afzuigpoort.
2.2 Verwijder het reservoir van de pomp.
3.  3.1 Bij verplaatsingen het reservoir altijd afsluiten met de pluggen.
4. Bij het legen van het reservoir en het afvoeren van vingertopslangen de lokale en interne voorschriften in acht nemen.
5.  5.1 Plaats een schoon reservoir.
5.2 Bevestig een nieuwe wegwerp vingertopslang aan de afzuigpoort.
6. Zet de pomp aan en stel het vacuüm in zoals door de arts voorgeschreven.

9 De afsluitkleppen vervangen

1.



1.1 Verwijder het reservoir.

2.

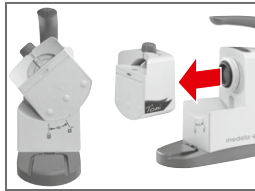

2.1 Kantel de veiligheidskamer 45° naar links.

2.2 Verwijder de veiligheidskamer door hem van de pomp af te trekken.

3.

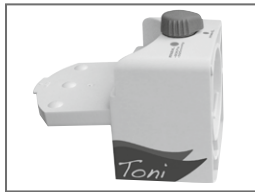

3.1 Open de veiligheidskamer.

4.

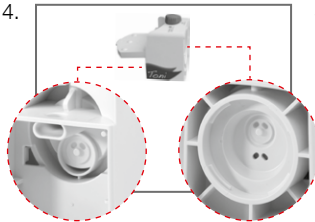

4.1 Vervang de defecte afsluitkleppen. Zorg ervoor dat de nieuwe afsluitkleppen correct worden bevestigd.

5. Bevestig de veiligheidskamer aan de pomp zoals beschreven in hoofdstuk 6.3.

10 De accu vervangen



WAARSCHUWINGEN

Alvorens de accu te vervangen eerst de Clario Toni uitschakelen en de stekker van de Clario Toni uit de wandcontactdoos trekken.



Alvorens deze handeling te verrichten eerst de stekker uit het stopcontact trekken.

1.

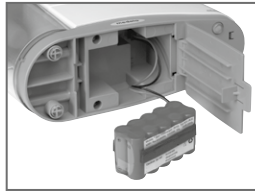

1.1 Open de klep van het accucompartiment aan de onderkant van de Clario Toni.

2.

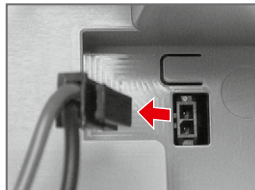

2.1 Maak de accukabel los door de plug uit de aansluiting te trekken.

3. Verwijder de oude accu.

4. Plaats de nieuwe accu.

5.

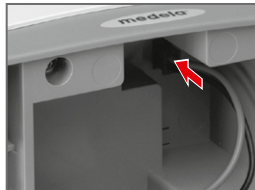

5.1 Sluit de accukabel aan door de plug in de aansluiting te steken.

6. Sluit de klep van het batterijcompartiment. Zorg ervoor dat de klep correct gesloten is en dat de accukabel niet klem of bekneld zit.

7. Kalibreer en test de accu (zie de hoofdstukken 11/12).

11 Accu-informatie en testen



ATTENTIE

Laad de accu alleen als het lampje voor ,opladen' langzaam knippert.

Pompduur

Als de accu volledig is geladen, bedraagt de gebruikstijd bij maximum vacuüm circa > 50 minuten.

Laadtijd (tot 100% geladen)

Circa 5 uur

Accustatus

brandt niet

De accu is volledig opgeladen

brandt

- De accu wordt opgeladen
- Stekker van de pomp is in het stopcontact gestoken

knippert langzaam

Accu is bijna leeg

knippert snel

Accu is defect

De oplaadbare accu testen

1. Zorg ervoor dat de accu volledig is geladen.

2. Haal de stekker van het apparaat uit het stopcontact.

3.

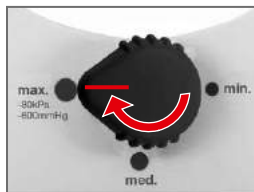

3.1 Zet de vacuümregelaar op positie "max.".

4.

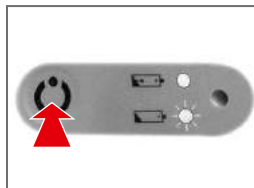

4.1 Zet de Clario Toni aan. De pomp gaat aan.

5. Neem op na hoeveel tijd de werking van de pomp stopt. De accu is in orde als de pomp > 50 minuten aan kan staan.

Als de pomp < 50 minuten aan kan staan, herhaal de test of kalibreer de accu (zie de volgende pagina).

12 Accu kalibreren



ATTENTIE

Voor het eerste gebruik en na opslagtijd > 2 maanden de accu kalibreren. Als het kalibreren niet geslaagd is, de accu vervangen.

De NiMH accu kalibreren

1. Zorg ervoor dat de accu volledig is geladen.
2. Haal de stekker van het apparaat uit het stopcontact.

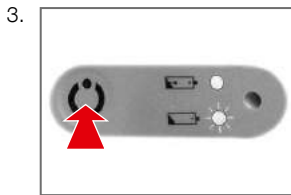

- 3.1 Zet de Clario Toni aan.
De pomp gaat aan.

4. Laat de pomp aan staan tot de accu leeg is en de pomp tot stilstand komt.
5. Steek de stekker van de Clario Toni in het stopcontact. De accu wordt opgeladen.
6. Wacht tot het laadlampje dooft.
7. Herhaal stap 1 tot 6. Nu is de Clario Toni AC / DC gereed voor gebruik.

Opslag van de accu

Om de zelfontlading tot een minimum te beperken, moet u de Clario Toni en de verwijderde oplaadbare vervangingsaccu's bij een temperatuur beneden 25 °C (77 °F) bewaren. De kalibratie-procedure om de 2–3 maanden herhalen.

13 Storingen opheffen

Motor loopt niet

Controleer of:

- de Clario Toni is ingeschakeld.
- de netspanning correct is en of de stekker op de juiste wijze in de wandcontactdoos is gestoken.
- de interne accu geladen is.

De pomp maakt teveel geluid

Controleer de positie en afdichting van de afsluitkleppen in de veiligheidskamer.

Ontoereikend vacuüm

Controleer of:

- de vacuümregelaar correct is ingesteld.
- de slangen niet beschadigd of gescheurd zijn. Indien nodig vervangen.
- alle verbindingen stevig vastzitten.
- het reservoir / deksel geen barsten, brokkelige delen, verkleuringen vertonen. Indien nodig vervangen.
- de afsluitkleppen in de veiligheidskamer correct worden afgedicht.
- het membraan schoon is en geen scheuren vertoont.

Levensduur accu onvoldoende

Accu kalibreren. Zie hoofdstuk 12.

Ledlampje brandt niet

De accu is volledig geladen.

Ledlampje brandt

- De accu wordt opgeladen.
- De stekker van de pomp is in het stopcontact gestoken.

Ledlampje knippert langzaam

De accu is bijna leeg. Het accuvermogen is toereikend om circa 10 minuten te pompen.

Ledlampje knippert snel

De accu is defect. Voor het vervangen van de defecte accu zie hoofdstuk 10.

14 Garantie en service

Garantie

Vanaf de datum van aankoop geeft Medela AG 2 jaar garantie op materiaal- en fabricagefouten van het product (voor de accu bedraagt de garantie 6 maanden).

Defect materiaal wordt gedurende deze periode gratis vervangen, mits de schade niet het gevolg is van verkeerd gebruik of onjuiste toepassing. De garantie geldt niet voor aan gebruiksslijtage onderhevige onderdelen. Om naleving van de garantievoorwaarden en een optimale werking van Medela-producten te waarborgen, adviseren wij alleen originele accessoires van Medela voor onze apparaten te gebruiken.

Medela AG is in geen geval aansprakelijk voor claims die buiten het bereik van de garantievoorwaarden vallen, zoals gevolgschade enz. Het recht op vervanging van defecte onderdelen door Medela komt te vervallen indien er door ongeautoriseerde personen werkzaamheden aan de pomp zijn uitgevoerd. De garantie is alleen geldig als het apparaat bij een servicecentrum van Medela wordt aangeboden.

Service

Reparatiewerkzaamheden mogen alleen door geautoriseerd Medela-personeel worden verricht. De servicehandleiding van Medela is op verzoek verkrijgbaar.

15 Afvalverwijdering

De Clario Toni bevat onderdelen van metaal en kunststof en moet worden afgevoerd conform de Europese richtlijnen 2011/65/EG en 2012/19/EG. Daarnaast moet ook aan de lokale voorschriften worden voldaan. Bij de AC / DC-versies moeten de elektronische componenten en de accu afzonderlijk in overeenstemming met de lokale voorschriften verwijderd worden. Zorg ervoor dat u de Clario Toni en de bijbehorende accessoires conform de lokale afvalvoorschriften afvoert.



Gebruikersinformatie voor het afvoeren van elektrische en elektronische apparatuur

Dit symbool betekent dat de elektrische en elektronische apparatuur niet met het normale huishoudelijke afval mag worden afgevoerd. Door het apparaat op de juiste wijze af te voeren, voorkomt u mogelijke schade aan het milieu of gezondheidsrisico's. Voor meer informatie over het afvoeren van de apparatuur neemt u contact op met de fabrikant, de lokale zorgverstrekker of uw gezondheidszorginstelling. Dit symbool geldt alleen binnen de Europese Unie. Neem de nationale wetten en voorschriften voor het afvoeren van elektrische en elektronische apparatuur in acht.

16 Richtlijnen voor het reinigen



WAARSCHUWINGEN

Na elk gebruik dienen onderdelen die in contact zijn geweest met de afgezogen secreties te worden gereinigd, gedesinfecteerd of afgevoerd **conform de tabel op de volgende pagina**.



Alvorens het apparaat te reinigen de stekker van het apparaat uit het stopcontact halen.

Algemene opmerkingen

- Hieronder volgen algemene aanbevelingen die, naargelang de specifieke richtlijnen, reinigingspraktijken en -voorschriften van het ziekenhuis, kunnen worden aangepast.
- Gedetailleerde informatie conform de Medela-reinigingsinstructies (productcode nr. 200.2391).
- Draag bij het reinigen / desinfecteren beschermende handschoenen.
- Vloeistoffen zoals bloed en secreties en de onderdelen die ermee besmet zijn, afvoeren overeenkomstig de voorschriften van het ziekenhuis.

Door Medela aanbevolen oppervlaktereinigingsmiddelen voor de pompbehuizing

- **CaviWipes**, Metrex Research, www.sybrondental.com
- **mikrozyd® AF wipes**, Schülke&Mayr GmbH, www.schuelke.com

Water

Gebruik bij het reinigen water met de hoogst mogelijke zuiverheid. Hard water kan grote problemen veroorzaken doordat afzettingen op medische producten mogelijk onvoldoende ontsmet worden. Gebruik gedeïoniseerd water om dit probleem te voorkomen. Het uiteindelijke spoelwater is vrij van bacteriën en endotoxinen.

Machines voor reiniging / desinfectie

Kunnen worden gebruikt om onderdelen uit de tabel op de volgende pagina te desinfecteren. Door te spoelen met heet water (maximumtemperatuur 100 °C) kan een gemiddeld tot hoog niveau van desinfectie worden bereikt. Elk onderdeel van de betreffende delen moet toegankelijk zijn, om een efficiënte reiniging te kunnen garanderen. Wij bevelen aan om reinigings-/desinfectieapparatuur te gebruiken die is goedgekeurd door het Robert Koch Institute en die voldoet aan de eisen van ISO 15883. De aanbevolen temperatuur voor niet-kritische medische apparatuur (die alleen met onaangestaste huid in aanraking komt) is 90 °C gedurende 1 minuut. Deze tijd wordt verhoogd tot 5 minuten voor alle medische apparatuur die als kritiek wordt beschouwd.



Producten voor eenmalig gebruik

Dit zijn producten voor eenmalig gebruik die niet geschikt zijn voor herverwerking. Herverwerking kan ten koste gaan van de mechanische, chemische en/of biologische eigenschappen. Hergebruik kan kruisbesmetting veroorzaken.

Reservoir, veiligheidskamer	Pompbehuizing Elektriciteitsnoer	
x	x	1. Demontage Haal alle onderdelen los voordat u ze reinigt, desinfecteert en steriliseert.
x		2. Reservoir en veiligheidskamer reinigen Reinig de onderdelen in heet water (60–70 °C) met een afwasmiddel met een pH-waarde tussen 6,0 en 8,0, om schade aan de instrumenten en overloopsystemen te voorkomen. Door een afwasmiddel te gebruiken dat enzymen bevat, kunt u organische materie zoals bloed gemakkelijker verwijderen. Afwasmiddelen conform het door de fabrikant aanbevolen concentratieniveau gebruiken. Er zijn alkalische reinigingsmiddelen die veilig zijn voor de herverwerking van medische apparatuur. De fabrikanten van dergelijke reinigingsmiddelen moeten informatie verstrekken over specifieke materialen die kunnen worden beschadigd door de oppervlakreactieve stoffen in het reinigingsmiddel. Week alle onderdelen gedurende 1–5 minuten grondig met warm water met een zeepoplossing of wasmiddel dat enzymen bevat. 1. Verwijder zichtbaar vuil met een hulpmiddel – schoonmaakborstels, zoals buisragers en niet-schurende schoonmaakdoekjes. De gebruikte borstels en buisragers moeten goed aansluiten, maar toch voldoende bewegingsvrijheid binnen het te reinigen gebied bieden. Grondig spoelen met schoon water. Laten drogen. 2. Controleer de instrumenten op zichtbaar vuil en herhaal de stappen indien nodig.
	x	3. Pompbehuizing en elektriciteitsnoer reinigen Afnemen met bovengenoemd reinigingsmiddel. Gebruik een schone doek om af te drogen.
x		4. Desinfecteren Week de onderdelen gedurende 30 minuten bij kamertemperatuur in een desinfectie-/reinigingsoplossing (A). Na afloop van de werkingstijd spoelt u het residu van de individuele onderdelen en spoelt u de slangen uit. Spoel gedurende ten minste 2 minuten met de reinigingsoplossing (B). (A) vloeibare aldehydevrije desinfectieoplossing met reinigende werking, te gebruiken als voorweekmiddel, bactericide, fungicide, virusdodend middel met beperkte werking. Geschikt voor roestvrij staal, niet-ijzerhoudende metalen en kunststoffen waaronder silicone, licht alkalisch. Bijv. 2% neodisher® Septo MEDsolution. (B) vloeibare, pH-neutrale, enzymatische reinigingsoplossing voor handmatige of machinale behandeling van instrumenten. Bijzonder geschikt voor roestvrij staal, niet-ijzerhoudende metalen en kunststoffen waaronder silicone, of gebruik een machine voor reiniging / desinfectie, of maak gebruik van een vaatwasmachine.
x		5. Het bewaren van onderdelen Na het desinfecteren de delen op een schone en droge doek bewaren.



17 Overzicht accessoires



WAARSCHUWINGEN

De werking van de Clario Toni is geverifieerd in combinatie met de volgende accessoires. Voor een juist en veilig gebruik de Clario Toni alleen met deze accessoires gebruiken. Nadere informatie vindt u op het instructieblad bij het desbetreffende accessoire.

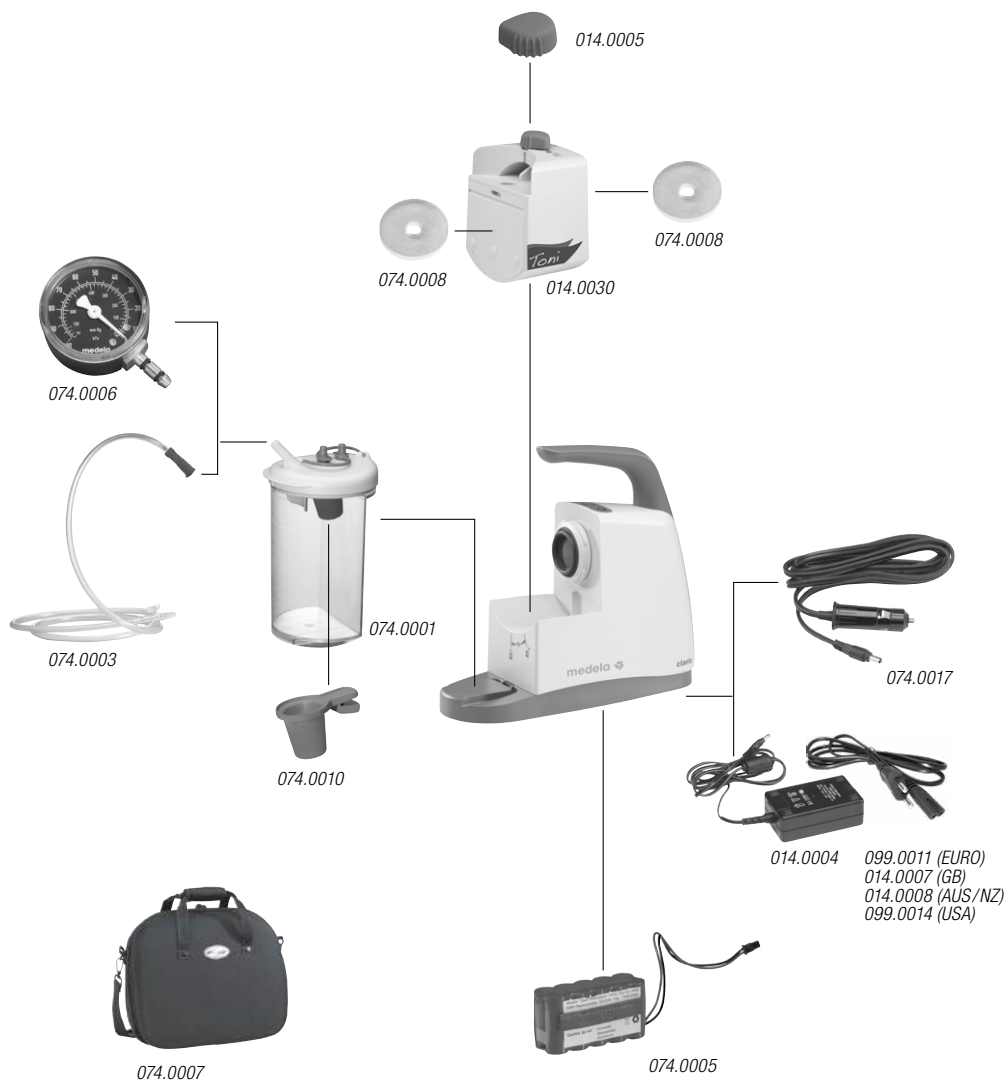

18 Legenda accessoires



Veiligheidstip

Indien er bij de pomp niet-originele accessoires of onderdelen worden gebruikt, dienen deze:

- voorzien te zijn van een CE-markering en (indien noodzakelijk) een lokaal certificaat;
- veilig op de Medela-accessoires te kunnen worden aangesloten, zonder dat de werking van de pomp wordt gehinderd.

Let op: combineert u Medela-onderdelen met onderdelen van derden, dan wordt u verantwoordelijk voor het gehele systeem.

REF

014.0030	Veiligheidskamer
014.0005	Vacuümregelaar
074.0008	Afsluitkleppen (10 stuks)
074.0001	Reservoirset
074.0010	Vlotter (10 stuks)
074.0003	Wegwerp vacuümslang met vingertopregeling, steriel
074.0005	Oplaadbare accu
014.0004	Spanningsadapter
099.0011	Elektriciteitssnoer (Europa)
099.0014	Elektriciteitssnoer (VS)
014.0007	Elektriciteitssnoer (VK)
074.0007	Draagtas
074.0017	Auto-aansluitkabel voor 12 V DC
074.0006	Vacuümmeter



19 Pictogrammen en symbolen



Dit symbool geeft aan dat het hulpmiddel voldoet aan de essentiële voorschriften van Richtlijn 93/42/EEG van de Raad van 14 juni 1993 inzake medische hulpmiddelen.



Dit symbool geeft de klasse van de pomp aan.



Dit symbool geeft een hulpmiddel van classificatie II aan.

IP21 Dit symbool wijst op bescherming tegen de schadelijke gevolgen van het binnendringen van vaste vreemde voorwerpen en van water.



Dit symbool geeft aan dat het hulpmiddel niet mag worden gebruikt na afloop van het getoonde jaar en maand.



Dit symbool geeft aan dat het hulpmiddel voor eenmalig gebruik is bedoeld. Het hulpmiddel niet hergebruiken.



Dit symbool wijst op het naleven van aanvullende veiligheidsvoorschriften voor medische elektrische apparatuur in de VS en Canada.



Dit symbool geeft het catalogusnummer van de fabrikant aan.



Dit symbool duidt op een toegepast onderdeel type BF.



Dit symbool geeft het serienummer van de fabrikant weer.



Dit symbool geeft de wettelijke specificaties van de pomp aan.



Dit symbool geeft aan dat de magnetische resonantie onveilig is.



Dit symbool geeft de barcode van de fabrikant aan.



Dit symbool geeft aan dat de gebruiksinstructies gevolgd moeten worden.



Dit symbool geeft aan dat er storing kan ontstaan in de omgeving van apparatuur die van dit symbool is voorzien.



Dit symbool geeft aan dat het apparaat is gesteriliseerd met ethyleenoxide.



Dit symbool geeft aan dat de gebruiksinstructies geraadpleegd moeten worden.



Dit symbool geeft de fabrikant aan.



Dit symbool geeft de temperatuurbepending aan bij gebruik, transport en opslag.



Dit symbool wijst op ATTENTIE of WAARSCHUWING m.b.t. het apparaat.



Dit symbool geeft de productiedatum aan (vier cijfers voor het jaar en twee cijfers voor de maand).



Dit symbool geeft de vochtigheidsbeperking aan bij gebruik, transport en opslag.



Dit symbool geeft een veiligheidstip aan.



Dit symbool geeft de luchtdrukbeperkingen aan bij bediening, transport en opslag.



Dit symbool wijst erop dat het apparaat niet gebruikt mag worden als de verpakking van het apparaat beschadigd is.



Dit symbool duidt op het aantal items waarvoor de inhoud voldoende is.



Dit symbool geeft aan dat het apparaat niet samen met ongesorteerd gemeentelijk afval dient te worden afgevoerd (geldt alleen in de EU).



Dit symbool wijst erop dat het materiaal deel uitmaakt van een hergebruik- / recyclingproces.



Dit symbool wijst op een kartonnen verpakking.



Dit symbool geeft aan dat het apparaat uit het zonlicht moet worden gehouden.



Dit symbool wijst erop dat het hulpmiddel breekbaar is en zorgvuldig moet worden behandeld.



Dit symbool geeft aan dat het apparaat niet nat mag worden



Dit symbool geeft het maximale vacuümniveau van de pomp aan.



Dit symbool geeft de flowniveaus van de pomp aan.



Dit symbool geeft de elektrische specificaties van de pomp aan.



Dit symbool betekent stroomwisseling.



Dit symbool betekent elektrische stroom met constante stroomrichting.



Dit symbool geeft het gewicht van de pomp aan.



Dit symbool geeft de afmetingen (l x b x h) van de pomp aan.

R_{only}

Dit symbool geeft aan dat het apparaat op medisch voorschrift gebruikt mag worden. LET OP: Volgens de federale wetgeving in de VS is de verkoop van dit apparaat, of de opdracht daartoe, voorbehouden aan een arts (uitsluitend voor de VS).

pcs

Dit symbool geeft het aantal stuks aan.

Z

20 Technische specificaties



min. vacuüm, – 70 mmHg / – 9 kPa (+/- 20 mmHg / +/- 2,6 kPa)
med. vacuüm, – 115 mmHg / – 15 kPa (+/- 30 mmHg / +/- 4 kPa)
max. vacuüm, – 600 mmHg / – 80 kPa (– 90 mmHg / – 12 kPa)

Gemeten op 0 m, atmosferische druk: 1.013hPa
Let op: vacuümniveaus kunnen afhankelijk van de locatie variëren (meter boven zeeniveau, atmosferische druk en temperatuur).



lage stroomsnelheid: 15 l/min. (+/- 10%)



2,0 kg / 4,4 lbs
Zonder reservoir



100–240 V, 50–60 Hz
12 V, 3,4 A, NiMH
Spanningsadapter
UE48-120340SPA1



ISO 13485
93/42/EEG Klasse IIa



l x b x h
223x255x95 mm

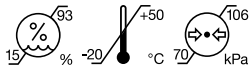

Transport-/opslagvoorwaarden



Transport/opslag
Oplaadbare accu

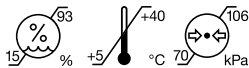

Bedrijfsvoorwaarden



IP21

21 Technische documentatie



WAARSCHUWINGEN

Gebruik alleen door de fabrikant gespecificeerde accessoires en gebruik alleen door de fabrikant geleverde onderdelen ter vervanging van interne componenten. Het niet opvolgen van deze aanwijzing kan verhoogde emissies veroorzaken of de immuniteit van de Clario Toni-pomp aantasten.

HF-chirurgische (hoge frequentie) uitrusting, radionetwerken enz. kunnen de werking van het apparaat beïnvloeden en mogen niet samen met de Clario Toni worden gebruikt.

EMC

De Clario Toni is EMC-getest conform de eisen van IEC 60601-1-2:2007 en IEC 60601-1-2:2014 4e editie in overeenstemming met de bepalingen 7 en 8.9. De Clario Toni is een medisch apparaat waarvoor bijzondere veiligheidsmaatregelen gelden betreffende de elektromagnetische compatibiliteit (EMC). Daarom moet de apparatuur worden geïnstalleerd en in gebruik worden genomen in overeenstemming met de bijgevoegde EMC-voorschriften.

Zie ook pagina's 326–329.



Innehållsförteckning

Gratulerar	164
1 Varningar och säkerhetsanvisningar	165
Säkerhetsanvisningar	167
2 Strömförsörjning och batteridrift	168
Låg batterispänning	168
Tomt batteri	168
3 Beskrivning	169
Inledning	169
Avsedd användning/indikationer	169
Kontraindikationer	169
Avsedd användare	169
Avsedd patientgrupp	169
Viktig anmärkning	169
4 Översikt	170
Definition av vakuum	170
Pumpversioner	170
Pumpens viktigaste delar	170
Membranets placering	171
Backventiler i säkerhetskammaren	171
Reglage och batteristatus	171
5 Installation	172
Kontroll av leverans	172
6 Förberedelse för användning	173
Kontroller före användning	173
Montering av behållaren	173
Montering av säkerhetskammaren	174
Anslutning av behållaren till pumpen	174
7 Driftsanvisningar	175
Anslutning av Clario Toni till elnätet	175
Funktionskontroll med vatten	176
Alternativt: funktionskontroll med manometern (tillbehör)	177
Justering av vakuumnivån	178
Urdrifttagning efter användning	178
8 Tömma behållaren	179
9 Byte av backventiler	180

10	Byte av uppladdningsbart batteri	181
11	Batteridata och test	182
	Pumptid.....	182
	Laddningstid (tills 100 % laddat).....	182
	Batteristatus.....	182
	Test av uppladdningsbart batteri.....	182
12	Batterikalibrering	183
	Kalibrering av uppladdningsbart NiMH-batteri.....	183
	Förvaring av uppladdningsbart batteri.....	183
13	Felsökning	184
	Motorn går inte.....	184
	Pumpen bullrar.....	184
	Otillräckligt vakuum.....	184
	Driftstiden för batteriet är otillräcklig.....	184
	Lysdioden lyser inte.....	184
	Lysdioden lyser.....	184
	Lysdioden blinkar sakta.....	184
	Lysdioden blinkar snabbt.....	184
14	Garanti och service	185
	Garanti.....	185
	Service.....	185
15	Avfallshantering	185
16	Riktlinjer för rengöring	186
	Allmänna anmärkningar.....	186
	Yt rengöringsmedel för pumphuset som Medela rekommenderar.....	186
	Vatten.....	186
	Rengörings-/desinfektionsmaskiner.....	186
	Engångsprodukter.....	186
17	Översikt över tillbehör	188
18	Lista över tillbehör	189
19	Skyltar och symboler	190
20	Tekniska specifikationer	192
21	Teknisk dokumentation	193
	Teknisk dokumentation/EMC.....	326

Gratulerar

Clario Toni är en högkvalitativ sugpump som kan anpassas till dina behov, och som ska användas enbart på läkares föreskrift. Produkten är enkel att använda, lätt att rengöra och erbjuder ett optimalt skydd mot överströmning. Apparatus membransystem har en elmotor. Tre vakuuminställningar gör det möjligt att reglera sugstyrkan till önskad nivå. Precis som alla Medelas sugpumpar ger den här pumpen enkel och tillförlitlig sugning. Den enkla användningen och rengöringen samt säkerhetsfunktionerna är ytterligare fördelar. Kontakta oss – vi hjälper dig gärna med råd.

1 Varningar och säkerhetsanvisningar



VARNINGAR

Anger en potentiellt farlig situation som om den inte avvärjs kan resultera i dödsfall eller allvarliga skador.



FÖRSIKTIGHET

Anger en potentiellt farlig situation som om den inte avvärjs kan resultera i mindre eller lindriga skador.



Säkerhetstips

Anger värdefull information om säker användning av produkten.

Clario Toni är uteslutande godkänd för sådan användning som beskrivs i dessa instruktioner. Medela kan enbart garantera att systemet fungerar säkert när Clario Toni används i kombination med Medelas originaltillbehör. Se kapitel 17/18.

Läs igenom och iaktta dessa varningar och säkerhetsanvisningar före användning. Denna bruksanvisning ska sparas tillsammans med apparaten för senare bruk.

Notera att denna bruksanvisning endast är en allmän vägledning för användning av produkten. Medicinska frågor ska alltid hanteras av läkare. Medela ansvarar endast för påverkan på Clario Tonis grundläggande säkerhet, tillförlitlighet och prestanda om den används i enlighet med bruksanvisningen.

FÖRSIKTIGHET: Enligt federala lagar i USA får apparaten endast säljas av eller på uppdrag av medicinsk personal.

Med reservation för ändringar.



VARNINGAR

- Får endast användas av medicinskt utbildad personal som fått fullgod utbildning i hur sugen ska användas.
- För patienter, hos vilka ett avbrott i systemet kan leda till en kritisk situation (t.ex. patienter med akut andnöd eller stark slembildning), måste alltid en reservapparat finnas tillgänglig.
- Apparaten får inte användas för att suga explosiva, lättantändliga eller korrosiva vätskor.
- Anslutningsslangen som levereras med apparaten får aldrig komma i direkt kontakt med sugområdet. En steril sugkateter måste alltid användas (infektionsrisk).
- Dra ut kontakten ur vägguttaget före rengöring av apparaten.
- Modifiering av apparaten är inte tillåtet.
- Koppla inte denna utrustning till en slang för passivt dränage.
- Följ indikationerna för användning och beakta riskfaktorer och kontraindikationer före användning av Clario Toni. Patienten kan skadas allvarligt eller avlida om samtliga instruktioner i denna bruksanvisning inte läses eller följs.
- Använd ej Clario Toni i MR-miljö (magnetresonans).
- Nätdaptern kan skadas på grund av händelser relaterade till elektrostatisk urladdning vid DC-porten på 15 kV.



FÖRSIKTIGHET

- Felaktig användning kan orsaka smärtor och skador hos patienten.
- Använd inte sterila tillbehör om den sterila förpackningen är skadad.
- Utrustning för trådlös kommunikation, såsom enheter för trådlösa hemnätverk, mobiltelefoner, sladdlösa telefoner och deras basenheter samt walkie-talkies, kan påverka Clario Toni och ska därför vara placerade minst 30 cm från utrustningen.
- Bärbar och mobil RF-kommunikationsutrustning kan påverka medicinska produkter.



Säkerhetstips

- För säkerhetstester antas att apparaten underhålls och repareras under hela sin livslängd i enlighet med serviceanvisningarna. Eftersom Clario Toni har säkerhetsklass II (EN IEC 60601-1, A1, A2:1995), är säkerhetstesterna begränsade till visuell översyn av hus och elkabel. Detta test måste utföras före varje användning.
- Test av patientläckström: Se servicehandboken för mer information.
- Clario Toni skyddas mot effekterna av en urladdning hos en hjärtstartare om korrekta kablar används.
- Apparaten är endast helt frånkopplad från elnätet när stickkontakten har dragits ut ur vägguttaget.
- Kontrollera att den lokala nätspänningen överensstämmer med den spänning som anges på typskylten innan apparaten ansluts.

Säkerhetsanvisningar

- Medela Clario Toni är en medicinteknisk apparat, vilket kräver särskilda säkerhetsåtgärder beträffande EMC (elektromagnetisk kompatibilitet). Den ska installeras och tas i drift enligt bifogad EMC-information.
- I vart och ett av följande fall får apparaten inte tas i bruk och ska repareras av serviceavdelning:
 - om elkabeln eller kontakten är skadad
 - om apparaten inte fungerar korrekt
 - om apparaten är skadad
 - om apparaten har uppenbara säkerhetsdefekter.
- Se till att elkabeln inte kommer i kontakt med varma ytor.
- Stickkontakten och strömbrytaren får inte komma i kontakt med fukt.
- Dra aldrig ut stickkontakten ur väggkontakten genom att dra i elkabeln!
- Lämna aldrig apparaten utan tillsyn då den är påslagen.
- Under drift ska pumpen stå upprätt.
- Dra aldrig elkabeln runt halsen.
- Ta aldrig apparaten i drift vid hög rumstemperatur, när du badar eller duschar, när du är väldigt trött eller befinner dig i område med explosionsrisk.
- Ställ aldrig apparaten i vatten eller i andra vätskor.
- Observera att sterila engångsprodukter inte får återanvändas.
Återanvändning kan orsaka mekaniska, kemiska och/eller biologiska skador.
Återanvändning kan orsaka korskontaminering.
- Kontakta din lokala Medela-representant för hjälp och rådgivning kring användning av utrustningen.
- Bär alltid handskar då du hanterar utrustningen.

Denna bruksanvisning ska sparas för senare användning.

2 Strömförsörjning och batteridrift

Clario Toni är en sugpump med strömförsörjning och batteridrift. Kontrollera att den lokala nätspänningen överensstämmer med den spänning som anges på typskylten innan apparaten ansluts. Om den används enligt bruksanvisningen har Clario Toni AC/DC-versionen en max. drifttid med batteri på 50 minuter innan den måste laddas på nytt. Om Clario Toni AC/DC-versionen inte används, måste batteriet kalibreras var 60:e–90:e dag.

Låg batterispänning

Vid batteridrift blinkar lysdioden sakta när det uppladdningsbara batteriet börjar bli urladdat. Clario Toni fungerar ytterligare en kort tid (ca 10 minuter) men batteriet måste laddas upp så snart som möjligt.

Tomt batteri

När det uppladdningsbara batteriet är tomt, stannar pumpen. Pumpen fungerar inte längre korrekt. Det uppladdningsbara batteriet måste laddas upp eller bytas ut.

3 Beskrivning

Inledning

Clario Toni är en högkvalitativ sugpump. Den har ett beprövat membransystem. Den kombinerar enkel hantering och rengöring med säkerhetsfunktioner för att garantera optimal drift. Får endast användas i enlighet med din läkares anvisningar och efter det att du fått instruktioner av medicinsk fackpersonal.

Avsedd användning

Sugpumpen Clario Toni är avsedd för att suga upp och avlägsna sekret, kroppsvätskor och främmande föremål från luftvägar eller system för andningshjälp i näsa, svalg och luftstrupe på barn och vuxna patienter. Sugpumpen lämpar sig för användning i hemmet, på sjukhus, i bilen eller utomhus.

Indidationer

Sugpumpen Clario Toni är avsedd för att frigöra luftvägarna antingen via näsan, munnen eller trakeotomin.

Kontraindikationer

Apparaten är inte avsedd för längre sugperioder.

Avsedd användare

Clario Toni får endast användas av korrekt instruerad personal. Personalen måste ha normal hörsel och syn. Instruktionerna ska repeteras minst en gång om året.

Avsedd patientgrupp

Clario Toni får endast användas på patienter som uppvisar de tillstånd som beskrivs i avsnittet om avsedd användning.

Viktig anmärkning

Läkaren och annan behörig personal ansvarar för att korrekta medicinska rutiner och metoder följs. Varje läkare måste utvärdera lämpligheten i behandlingen utifrån sin egen kunskap och erfarenhet.

4 Översikt

Definition av vakuum

I samband med användning av medicinsk sugutrustning, anges vakuum normalt som skillnaden (i absoluta tal) mellan absolut tryck och atmosfäriskt tryck eller som negativa värden i kilopascal (kPa). I detta dokument avser uppgiften -10 kPa exempelvis alltid ett tryckområde i kPa under det atmosfäriska omgivningstrycket (i enlighet med SS-EN ISO 10079-1999).

Pumpversioner



Clario Toni AC/DC

Pumpens viktigaste delar



Membranets placering



Backventiler i säkerhetskammaren

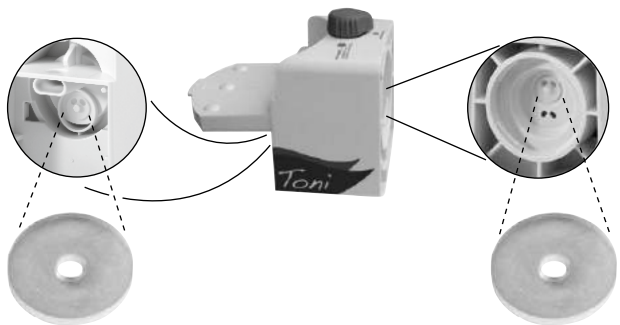

SV

Reglage och batteristatus



Vakuumregulator

Strömbrytare

Lysdiod för uppladdningsbart batteri

släckt Batteriet fulladdat

tänd – Batteriet laddas
– Pumpen är ansluten

blinkar långsamt Batteriet är snart tomt

blinkar snabbt Batteriet är defekt

5 Installation

Kontroll av leverans

Kontrollera att Clario Tonis förpackning är komplett och i gott skick.



Clario Toni-versioner

REF	Clario Toni AC/DC	014.00XX
	Clario Toni Deluxe	014.00XX



Engångsfingertoppsslang

REF 074.0003



Nätadapter

REF 014.0004

Elkabel

099.0011 (EU)

014.0007 (UK)

014.0008 (AUS/NZ)

099.0014 (USA)



Bruksanvisning

REF 200.8400



VARNINGAR

Anslutningsslangen som levereras med apparaten får aldrig komma i direkt kontakt med sugområdet. En steril sugkateter måste alltid användas (infektionsrisk).

6 Förberedelse för användning



VARNINGAR

Får endast användas av medicinskt utbildad personal som fått fullgod utbildning i hur sugen ska användas. Bär alltid handskar då du hanterar utrustningen.



FÖRSIKTIGHET

- Clario Toni måste stå upprätt under drift.
- Kontrollera att förpackningen för sterila tillbehör är hel före användning.
- Icke-sterila och återanvändbara tillbehör måste rengöras, desinfekteras och/eller steriliseras i enlighet med Medelas riktlinjer för rengöring (artikelnummer 200.2391).

6.1 Kontroller före användning

- Kontrollera före användning om Clario Toni-systemet har skador på elkabeln eller stickkontakten, uppenbara skador eller säkerhetsdefekter, samt att apparaten fungerar korrekt.
- Kontrollera att förpackningen för Clario Toni är komplett och i gott skick.
- Kontrollera att det uppladdningsbara batteriet är kalibrerat enligt kapitel 12.
- Kontrollera alla tillbehör före användning:
 - Sprickor, defekter och bräckliga ställen på sugbehållare och lock. Byt ut om nödvändigt.
 - Sprickor och bräckliga ytor på slangar och att anslutningarna sitter stadigt fast. Byt ut om nödvändigt.

6.2 Montering av behållaren



1.1 Fäst flottören på behållaren.



2.1 Fäst locket på behållaren. Kontrollera markeringarna på framsidan av behållaren och locket.

6.3 Montering av säkeretskammaren

1.

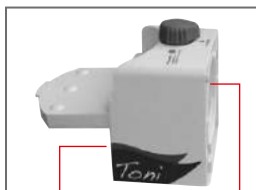

1.1 Öppna locket på säkeretskammaren.

2.

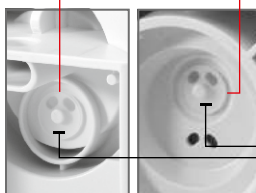

2.1 Kontrollera att båda ventilerna (silikonskivor) är monterade i säkeretskammaren. Se kapitel 4.

3.



3.1 Kontrollera att locket på säkeretskammaren är korrekt stängt.

4.



4.1 Vrid säkeretskammaren 45° åt vänster för att montera den på motorenheten.

4.2 Vrid säkeretskammaren till upprätt position tills du hör ett klick.

6.4 Anslutning av behållaren till pumpen

1.



1.1 Anslut behållaren till pumpen. Tryck hårt.

2.



2.1 Anslut engångsfinger-toppsslangen till suguttaget.

7 Driftsanvisningar



FÖRSIKTIGHET

Clario Toni ska installeras så att det är enkelt att koppla ifrån den från elnätet. Kalibrera det uppladdningsbara batteriet före första användningen.



VARNINGAR

Får endast användas av medicinskt utbildad personal som fått fullgod utbildning i hur sugen ska användas. Bär alltid handskar då du hanterar utrustningen.

7.1 Anslutning av Clario Toni till elnätet

1. Kontrollera pumpen före användning enligt instruktionerna i kapitel 6.1.

2. **Alla versioner: Om pumpen är ansluten till ett vägguttag:**

Anslut stickkontakten på elkabeln till ett vägguttag.

eller

Om pumpen drivs med 12 V DC:

Anslut anslutningskabeln för 12 V DC (tillbehör) till pumpen och till spänningskällan för 12 V DC.

eller

Om pumpen drivs med det uppladdningsbara batteriet:

Ingen anslutning till spänningskällan behövs. Kontrollera att batteriet har laddats i fem timmar.

7.2 Funktionskontroll med vatten

1.

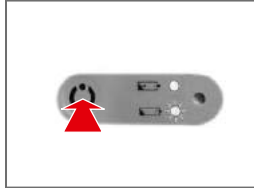

1.1 Tryck på strömbrytaren för att starta pumpen.

2.

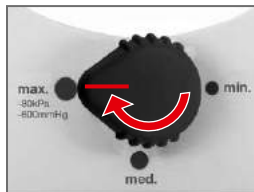

2.1 Ställ in vakuumpregulatorn på läget "max.".

3.

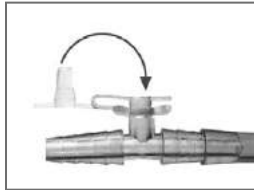

3.1 Anslut fingertoppsslangen.
Se kapitel 6.4, steg 2.1.
3.2 Förslut fingertoppsuttaget.

4.

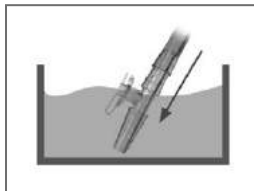

4.1 Sätt ner spetsen i vatten och kontrollera suget.

5. Fortsätt med steg 6 om det fungerar. Om inte, se kapitel 13.

6. Använd den kateter- och vakuuminställning som föreskrivits av läkaren.

7.3 Alternativt: funktionskontroll med manometern (tillbehör)



1.1 Anslut manometern till suguttaget.

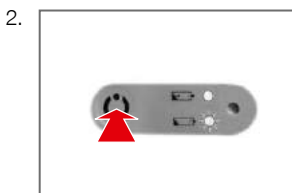

2.1 Tryck på strömbrytaren för att starta pumpen.

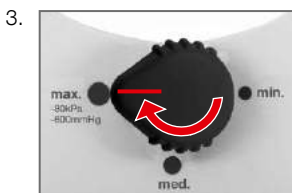

3.1 Ställ in vakuumregulatorn på läget "max.".

Höjd över havet:	Max. vakuum:
+ 2000 m	- 63 kPa - 471 mmHg
+ 1000 m	- 71 kPa - 532 mmHg
+ 500 m	- 76 kPa - 566 mmHg
0 m	- 80 kPa - 600 mmHg

(Tolerans: - 15%)



4.1 Jämfört vakuumet med värdena i tabellen till vänster.

5. Fortsätt med steg 6 om vakuumet är korrekt. Om inte, se kapitel 13.

6. Anslut fingertoppsslangen.

7. Använd den kateter- och vakuuminställning som föreskrivits av läkaren.



VARNINGAR

Får endast användas av medicinskt utbildad personal som fått fullgod utbildning i hur sugen ska användas. Bär alltid handskar då du hanterar utrustningen.

7.4 Justering av vakuumnivån

1.

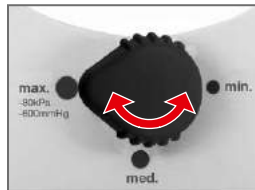

1.1 Ställ in vakuumregulatorn i erforderligt läge.

7.5 Urdrifftagning efter användning

1.

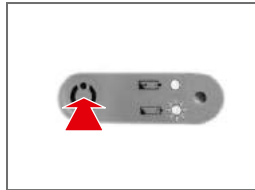

1.1 Tryck på strömbrytaren för att stänga av pumpen.

2. Om pumpen är ansluten till ett vägguttag:

Dra ut stickkontakten ur vägguttaget.

eller

Om pumpen är ansluten till en spänningsförsörjning med 12 V DC:

Lossa kontakten från spänningsförsörjningen med 12 V DC.





3. Rengör och desinfektera Clario Toni. Se kapitel 16.

8 Tömma behållaren



Säkerhetstips

Behållaren ska tömmas dagligen eller senast när vätskenivån når 550 ml och flottören stoppar sugningen till behållaren.

- 1. Tryck på strömbrytaren för att stänga av pumpen.
- 2.1 Lossa engångsfingertoppsslangen från suguttaget.
2.2 Ta bort behållaren från pumpen.
- 3.1 Förslut alltid behållaren med pluggarna vid transport.
4. Töm behållaren och kassera fingertoppsslangen enligt lokala och interna direktiv.
- 5.1 Montera en ren behållare.
5.2 Anslut den nya engångsfingertoppsslangen till suguttaget.
6. Starta pumpen och ställ in vakuuemet enligt läkarens föreskrifter.

9 Byte av backventiler

1.



1.1 Ta bort behållaren.

2.

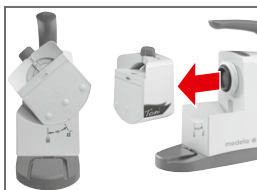

2.1 Vrid säkerhetskammaren 45° till vänster.

2.2 Ta bort säkerhetskammaren genom att dra av den från pumpen.

3.



3.1 Öppna säkerhetskammaren.

4.

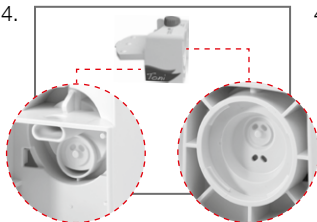

4.1 Byt ut defekta backventiler. Kontrollera att de nya backventilerna sitter korrekt.

5. Montera säkerhetskammaren på pumpen enligt beskrivningen i kapitel 6.3.

10 Byte av uppladdningsbart batteri



VARNINGAR

Stäng av Clario Toni och dra ut Clario Tonis stickkontakt från vägguttaget innan det uppladdningsbara batteriet ska bytas ut.

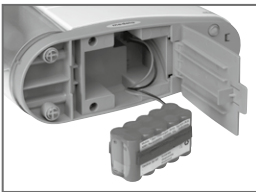
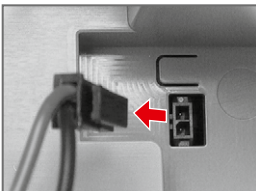
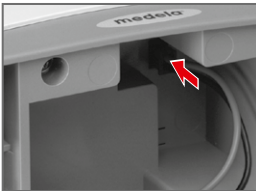

Dra ut stickkontakten ur vägguttaget före byte av det uppladdningsbara batteriet.

- 1. Öppna locket för batteriutrymmet på undersidan av Clario Toni.
- 2. Lossa batterikabeln genom att dra ut kontakten.
3. Ta ut det gamla uppladdningsbara batteriet.
4. Sätt in ett nytt uppladdningsbart batteri.
- 5.1 Anslut batterikabeln på nytt genom att ansluta kontakten.
6. Stäng locket för batteriutrymmet. Kontrollera att locket är korrekt stängt och att batterikabeln inte är klämd.
7. Kalibrera och testa det uppladdningsbara batteriet (se kapitel 11/12).

11 Batteridata och test



FÖRSIKTIGHET

Ladda det uppladdningsbara batteriet endast om laddningslampan blinkar sakta.

Pumptid

Om batteriet är fulladdat, är driftstiden vid max. vakuum ca > 50 minuter.

Laddningstid (tills 100 % laddat)

Ca 5h

Batteristatus

släckt

Batteriet fulladdat

tänd

- Batteriet laddas
- Pumpen är ansluten

blinkar långsamt

Batteriet är snart tomt

blinkar snabbt

Batteriet är defekt

Test av uppladdningsbart batteri

1. Kontrollera att det uppladdningsbara batteriet är fulladdat.
2. Dra ut stickkontakten ur vägguttaget.

3.

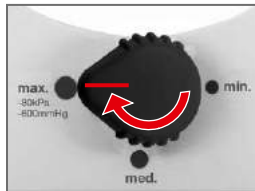

3.1 Ställ in vakuumregulatorn på läget "max.".

4.

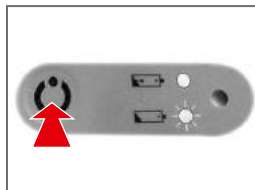

4.1 Starta Clario Toni. Pumpen startar.

5. Mät tiden tills pumpen stannar. Batteriet fungerar om driftstiden är > 50 minuter.

Gör om testet eller kalibrera batteriet (se nästa sida) om driftstiden är < 50 minuter.

12 Batterikalibrering



FÖRSIKTIGHET

Kalibrera det uppladdningsbara batteriet före första användningen och efter att det inte har använts på > 2 månader. Byt ut batteriet om kalibreringen inte fungerar.

Kalibrering av uppladdningsbart NiMH-batteri

1. Kontrollera att det uppladdningsbara batteriet är fulladdat.
2. Dra ut stickkontakten ur vägguttaget.

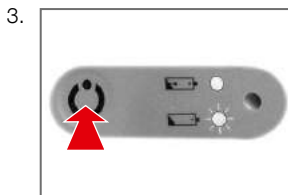

3.1 Starta Clario Toni.
Pumpen startar.

4. Låt pumpen gå tills det uppladdningsbara batteriet är tomt och pumpen stannar.
5. Anslut Clario Toni till ett vägguttag.
Det uppladdningsbara batteriet laddas.
6. Vänta tills laddningslampan slocknar.
7. Upprepa steg 1 till 6. Clario Toni AC/DC är då klar att användas.

Förvaring av uppladdningsbart batteri

För att hålla självurladdningen på ett minimum bör Clario Toni och de urtagna reservbatterierna lagras vid temperaturer under 25 °C (77 °F). Upprepa kalibreringen med 60–90 dagars mellanrum.

13 Felsökning

Motorn går inte

Kontrollera följande:

- Clario Toni är på.
- elnätets spänning är korrekt och stickkontakten är korrekt ansluten till vägguttaget.
- det interna batteriet laddas.

Pumpen bullrar

Kontrollera positionen och tätningen för backventilerna i säkerhetskammaren.

Otillräckligt vakuum

Kontrollera följande:

- vakuumregulatorn är korrekt inställd.
- slangarna är inte defekta. Byt ut om nödvändigt.
- alla slangkopplingar sitter ordentligt.
- sugbehållaren/-locket har inte sprickor, bräckliga ytor eller missfärgningar. Byt ut om nödvändigt.
- tätningen för backventilerna i säkerhetskammaren är tät.
- membranet är rent och har inga sprickor.

Driftstiden för batteriet är otillräcklig

Kalibrera det uppladdningsbara batteriet. Se kapitel 12.

Lysdioden lyser inte

Det uppladdningsbara batteriet är fulladdat.

Lysdioden lyser

- Det uppladdningsbara batteriet laddas.
- Pumpen är ansluten.

Lysdioden blinkar sakta

Det uppladdningsbara batteriet är nästan urladdat. Batteriet räcker för ca 10 minuters drift.

Lysdioden blinkar snabbt

Det uppladdningsbara batteriet är defekt. För byte av defekt batteri, se kapitel 10.

14 Garanti och service

Garanti

Medela AG garanterar att apparaten är fri från defekter i material och konstruktion under 2 år (6 månader för det uppladdningsbara batteriet) från leveransdatum. Defekt material ersätts utan kostnad under den här perioden om de inte har uppkommit på grund av felaktig användning. Garantin omfattar inte delar som är utsatta för slitage. För att garantireglerna ska uppfyllas samt för att få ut allt av Medelas produkter rekommenderar vi att endast Medelas tillbehör används med våra apparater.

Medela AG ansvarar aldrig för anspråk som går utöver den beskrivna garantins omfattning inklusive ansvar för sekundära skador, etc. Rätten att byta defekta delar godkänns inte av Medela om arbete på pumpen har utförts av icke-auktoriserade personer. Apparaten ska returneras till Medelas servicecenter vid garantiärenden.

Service

Servicearbete får enbart utföras av personal auktoriserad av Medela. Medelas servicehandbok tillhandahålls om så önskas.

SV

15 Avfallshantering

I Clario Toni ingår metaller och plaster som ska avfallshanteras i enlighet med de europeiska direktiven 2011/65/EG och 2012/19/EG. Dessutom måste även lokala riktlinjer iakttas. På AC/DC-versionen ska de elektroniska komponenterna samt det uppladdningsbara batteriet avfallshanteras i enlighet med lokala föreskrifter. Kontrollera att Clario Toni och dess tillbehör avfallshanteras i enlighet med lokala riktlinjer för avfallshantering.



Användarinformation för avfallshantering av elektrisk och elektronisk utrustning

Symbolen innebär att elektrisk och elektronisk utrustning inte får slängas med vanligt hushållsavfall. Korrekt avfallshantering av apparaten skyddar och förhindrar eventuella skador på miljön och människor. Kontakta tillverkaren eller din lokala sjukvård för mer information. Symbolen är endast giltig i EU. Följ relevanta statliga lagar och bestämmelser i ditt land för avfallshantering av elektrisk och elektronisk utrustning.

16 Riktlinjer för rengöring



VARNINGAR

Efter varje användning ska de delar som varit i kontakt med utsuget sekret rengöras, desinfekteras, steriliseras eller kasseras i **enlighet med tabellen på nästa sida**.



Dra ut stickkontakten ur vägguttaget före rengöring av apparaten.

Allmänna anmärkningar

- Detta är endast allmänna rekommendationer som kan ändras individuellt, i enlighet med sjukhusets specifika direktiv och rengöringspolicy.
- Ytterligare information finns i Medelas rengöringsinstruktioner (produktkod 200.2391).
- Använd skyddshandskar för rengöring/disinfektion.
- Kassera vätskor som blod och sekret och delar som är kontaminerade av dessa i enlighet med sjukhusets interna riktlinjer.

Yt rengöringsmedel för pumphuset som Medela rekommenderar

- **CaviWipes**, Metrex Research, www.sybrondental.com
- **mikrozyd® AF wipes**, Schülke&Mayr GmbH, www.schuelke.com

Vatten

Använd endast rent vatten av högsta kvalitet för rengöring. Vattnets hårdhet är en viktig faktor eftersom avlagringar på medicinska produkter förhindrar en effektiv dekontaminering. Använd avjoniserat vatten för att förebygga detta problem. Sköljvatten ska vara fritt från bakterier och endotoxiner.

Rengörings-/desinfektionsmaskiner

Kan användas för att desinfektera delar angivna i tabellen på nästa sida. Varmvattensköljning (max. temperatur 100 °C) ger en medelhög till hög nivå av desinfektion. Det måste gå att nå varje enskild del för att rengöringen ska bli tillräcklig. Vi rekommenderar en rengörings-/desinfektionsmaskin som är godkänd av Robert Koch-institutet och uppfyller SS-EN ISO 15883.

Rekommenderad temperatur för icke-kritisk medicinsk utrustning (d.v.s. den som endast kommer i kontakt med oskadad hud) är 90 °C under 1 minut. Tiden ska ökas till 5 minuter för all medicinsk utrustning som anses vara kritisk.



Engångsprodukter

Detta är engångsprodukter som inte ska återanvändas. Regenerering kan orsaka mekaniska, kemiska och/eller biologiska skador. Återanvändning kan orsaka korskontaminering.

Behållare, säkerhetskammare	Pumphus Elkabel	
x	x	1. Demontering Lossa alla separata delar före rengöring, desinfektion och sterilisering.
x		2. Rengöring av behållare och säkerhetskammare Rengör delarna i varmt vatten (60–70 °C) med ett rengöringsmedel med ett pH på mellan 6,0 och 8,0 för att undvika skador på instrument och behållare. Enzymatiskt rengöringsmedel tar bort organiskt material som t.ex. blod. Rengöringsmedel ska användas i enlighet med tillverkarens rekommenderade koncentrationer. Vissa alkaliska rengöringsmedel har en sammansättning som gör dem lämpliga för rengöring av medicinsk utrustning. Tillverkare av dessa rengöringsmedel ska tillhandahålla information om specifika material som kan skadas av rengöringsmedlen. Blötlägg alla delar noga i varm tvållösning eller enzymatiskt rengöringsmedel under 1–5 minuter. 1. Ta bort synlig smuts med ett rengöringsverktyg – vanliga rengöringsborstar som piprensare eller trasor som inte åstadkommer repor. Borstar och piprensare ska passa exakt och samtidigt gå åt förflytta enkelt i det område som ska rengöras. Skölj noga med rent vatten. Låt torka 2. Kontrollera om det finns synlig smuts på instrumenten och upprepa stegen ovan vid behov.
	x	3. Rengöring av pumphus och nätkabel Torka med rengöringsmedlen ovan. Torka torrt med en ren trasa.
x		4. Desinfektera Blötlägg i rumstemperatur under 30 minuter i en desinfektions-/rengöringslösning (A). Skölj med vatten efter reaktionstiden för att ta bort lösningsrester från enstaka delar och slangen. Skölj under minst 2 minuter med rengöringslösning (B). (A) Desinfektionslösning utan aldehyd med rengöringseffekt för blötläggning och baktericid, fungicid samt begränsad virucid effekt med god materialkompatibilitet med rostfritt stål, icke-järnmaterial och plast inkl. silikon, något alkalisk. t.ex. 2 % neodisher® Septo MEDsolution. (B) Vätska, pH-neutral, enzymatisk rengöringslösning för rengöring av instrument med maskin eller för hand med mycket god materialkompatibilitet med rostfritt stål, icke-järnmaterial och plast inkl. silikon. eller använd rengörings-/desinfektionsmaskin. eller använd diskmaskin.
x		5. Förvaring av delar Förvara delarna på en ren och torr trasa efter desinficering.

17 Översikt över tillbehör



VARNINGAR

Clario Toni är godkänd i kombination med tillbehören nedan. Använd endast Clario Toni tillsammans med dessa tillbehör för korrekt och säker användning. Mer information finns på de enskilda tillbehörens instruktionsblad.

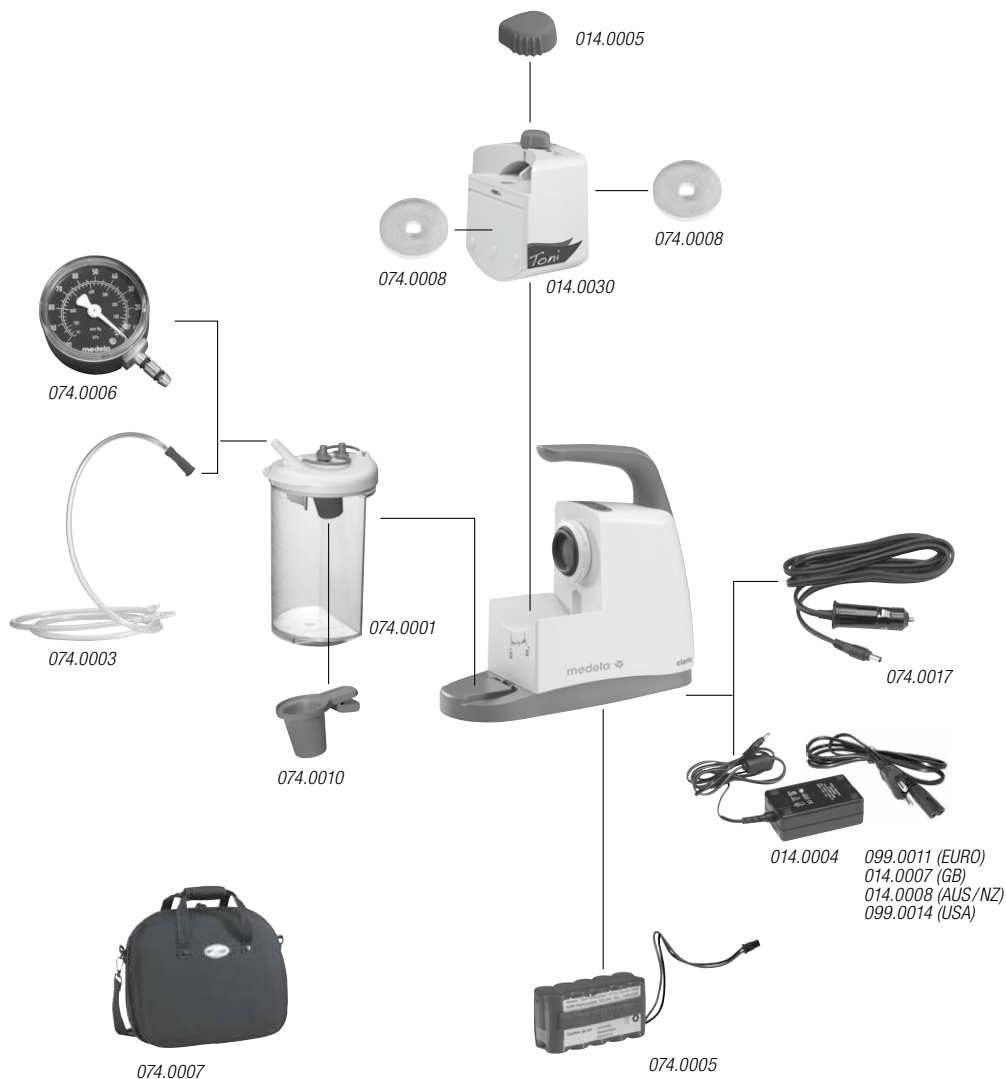

18 Lista över tillbehör



Säkerhetstips

Om pumpen används tillsammans med delar från andra tillverkare än Medela ska de uppfylla följande:

- vara CE-märkta och (om nödvändigt) lokalt registrerade
- kunna anslutas säkert till Medelas tillbehör utan att påverka pumpens prestanda.

Obs! Om du kombinerar delar från Medela med delar från andra tillverkare ansvarar du för hela systemet.

REF

- 014.0030 Säkerhetskammare
- 014.0005 Vakuumregulator
- 074.0008 Backventiler (10 st.)
- 074.0001 Behållarset
- 074.0010 Flottör (10 st.)
- 074.0003 Engångsfingertoppsslang
- 074.0005 Uppladdningsbart batteri
- 014.0004 Nätadapter
- 099.0011 Elkabel (EU)
- 099.0014 Elkabel (USA)
- 014.0007 Elkabel (GB)
- 074.0007 Bärväska
- 074.0017 Bilanslutningskabel för 12 V DC
- 074.0006 Manometer

19 Skyltar och symboler



0123
Symbolen anger att apparaten uppfyller de grundläggande kraven i Rådets direktiv 93/42/EEG av den 14 juni 1993 om medicinsk utrustning.



Symbolen anger pumpklass.



Symbolen anger en klass II-apparat.

IP21

Symbolen anger skydd mot skadliga följder på grund av inträngande föremål samt mot skadliga följder på grund av inträngande vatten.



Symbolen anger att apparaten inte får användas efter angivet år och angiven månad.



Symbolen anger en engångsapparat. Återanvänd inte produkten.

REF

Symbolen anger tillverkarens katalognummer.

SN

Symbolen anger tillverkarens serienummer.

LOT

Symbolen anger tillverkarens batchnummer.

STERILEEO

Symbolen anger att apparaten är steriliserad med etylenoxid.



Symbolen anger att apparaten uppfyller US-amerikanska och kanadensiska säkerhetsbestämmelser för medicinsk utrustning.



Symbolen anger att delen är säkerhetsklassad som typ BF.



Symbolen anger MR UNSAFE (olämplig i magnetresonansmiljöer).



Symbolen anger att störningar kan inträffa i närheten av utrustning märkt med denna symbol.



Symbolen anger temperaturbegränsningarna för drift, transport och förvaring.



Symbolen anger lufttuthetsbegränsningar för drift, transport och förvaring.



Symbolen anger pumpens juridiska specifikationer.



Symbolen anger att bruksanvisningen ska följas.



Symbolen anger att bruksanvisningen ska följas.



Symbolen anger FÖRSIKTIGHET eller VARNING som är förknippad med enheten.



Symbolen anger tillverkaren.



Symbolen anger tillverkningsdatum (fyra siffror för året och två siffror för månaden).



Symbolen anger ett säkerhetstips.



Symbolen anger de atmosfäriska tryckbegränsningarna för drift, transport och förvaring.



Symbolen anger att apparaten ska hållas torr.



Symbolen anger att apparaten inte ska användas om förpackningen är skadad.



Symbolen anger pumpens maximala vakuumnivå.



Symbolen anger pumpens flödesnivå.



Symbolen anger antal n som innehållet räcker till.



Symbolen anger pumpens elektriska specifikationer.



Symbolen anger att apparaten inte får avfallshanteras som hushållsavfall (gäller endast EU).



Symbolen anger växelström.



Symbolen anger likström.



Symbolen anger att materialet är en del av en återvinningsprocess.



Symbolen anger pumpens vikt.



Symbolen anger en kartongförpackning.



Symbolen anger pumpens mått (H x B x D).



Symbolen anger att apparaten inte ska utsättas för solljus.



Symbolen anger en receptbelagd apparat. FÖRSIKTIGHET: Enligt federala lagar i USA får apparaten endast säljas av eller på uppdrag av medicinsk personal (gäller endast USA).



Symbolen anger att apparaten ska hanteras varsamt.

pcs Symbolen anger antalet enheter.

20 Tekniska specifikationer



Min. vakuüm, - 70 mmHg / - 9 kPa (+/- 20 mmHg / +/- 2.6 kPa)
Med. vakuüm, - 115 mmHg / - 15 kPa (+/- 30 mmHg / +/- 4 kPa)
Max. vakuüm, - 600 mmHg / - 80 kPa (- 90 mmHg / - 12 kPa)

Beräknat vid 0 m, atmosfäriskt tryck: 1 013 hPa
Observera: Vakuümnivåerna kan variera beroende på plats (meter över havet, atmosfäriskt tryck och temperatur).



Lågt flöde: 15l/min. (+/- 10%)



2,0 kg / 4,4 lbs
Utan behållare



100-240 V, 50-60 Hz
12 V, 3,4 A, NiMH
Nätadapter
UE48-120340SPA1



ISO 13485
93/42 EEC klass IIa



HxBxD
223x255x95 mm

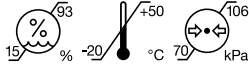

Transport/förvaringsförhållanden



Transport/förvaring
Uppladdningsbart batteri

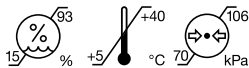

Driftsförhållanden



IP21

21 Teknisk dokumentation



VARNINGAR

Använd inte andra tillbehör än de som anges här eller säljs av tillverkaren som reservdelar för inre delar. Det kan leda till ökad utströmning eller försämrad immunitet hos Clario Toni.

Högfrekvent kirurgisk utrustning, radionätverk och liknande kan påverka apparatens funktion och får inte användas i kombination med Clario Toni.

EMC

Clario Toni är EMC-testad i enlighet med kraven i IEC 60601-1-2:2007 och IEC 60601-1-2:2014, fjärde upplagan enligt artikel 7 och 8.9. Clario Toni är en medicinteknisk produkt, vilket kräver särskilda säkerhetsåtgärder beträffande EMC (elektromagnetisk kompatibilitet), och produkten måste installeras och användas i enlighet med bifogade EMC-uppgifter.

Se även sidorna 326–329.

Sisällysluettelo

Onnitellut	196
1 Varoitukset ja turvaohjeet	197
Turvaohjeet	199
2 Virtalähde ja akkukäyttö	200
Akun virta vähissä.....	200
Akku tyhjä.....	200
3 Kuvaus	201
Johdanto	201
Käyttötarkoitus/indikaatiot	201
Vasta-aiheet.....	201
Aiottu käyttäjä.....	201
Aiottu potilasryhmä.....	201
Tärkeä huomautus.....	201
Käyttöikä.....	201
4 Yleiskatsaus	202
Tyhjiön määrittely.....	202
Pumpun versiot.....	202
Pumpun tärkeimmät osat	202
Kalvon sijainti	203
Venttiililaatat turvakammiossa	203
5 Asennus	204
Tarkista alkuperäinen toimitus	204
6 Käytön valmistelu	205
Tarkistettavaa ennen käyttöä	205
Säiliön asennus.....	205
Turvakammion asennus.....	206
Säiliön kiinnittäminen pumppuun	206
7 Käyttöohjeet	207
Kytke Clario Toni verkkovirtaan.....	207
Toiminnan tarkistaminen vedellä.....	208
Vaihtoehto: toimintojen tarkistus lisävarusteena saatavalla mittarilla	209
Tyhjiötason muuttaminen.....	210
Käytöstä poistaminen käytön jälkeen	210
8 Säiliön tyhjentäminen	211
9 Venttiililaattojen vaihtaminen	212

10 Akun vaihtaminen	213
11 Akun tiedot ja testaus	214
Pumppauksen kesto.....	214
Latausaika (100-prosenttisesti ladattu).....	214
Akun tila.....	214
Akun testaaminen.....	214
12 Akun kalibrointi	215
NiMH-akun kalibrointi.....	215
Akun säilytys.....	215
13 Vianetsintä	216
Moottori ei käynnissä.....	216
Pumppu on liian äänekäs.....	216
Riittämätön imuteho.....	216
Käyntiaika akulla riittämätön.....	216
LED-valo ei pala.....	216
LED palaa.....	216
LED vilkkuu hitaasti.....	216
LED vilkkuu nopeasti.....	216
14 Takuu ja huolto	217
Takuu.....	217
Huolto.....	217
15 Hävittäminen	217
16 Puhdistusohjeet	218
Yleisiä huomautuksia.....	218
Medelan suosittelemat pintapuhdistusaineet pumpun kotelolle.....	218
Vesi.....	218
Puhdistus-/desinfiointilaitteet.....	218
Kertakäyttötuotteet.....	218
17 Yleiskuva lisävarusteista	220
18 Lisävarusteiden kuvateksti	221
19 Merkit ja symbolit	222
20 Tekninen erittely	224
21 Tekninen dokumentaatio	225
Tekninen dokumentaatio/EMC.....	326

Onnittelut

Valitsemalla Clario Tonin olet hankkinut korkealuokkaisen imupumpun, jota tulee käyttää tarpeidesi mukaan ainoastaan lääkärin määräyksestä. Tässä tuotteessa on ainutlaatuinen kolmikertainen hygieeninen rakenne ja paras mahdollinen ylivuotosuoja. Se toimii kalvojärjestelmällä, jossa on sähkömoottori. Kolmea tyhjiöasetusta käyttäen voidaan imuvoima säätää tarvittavalle tasolle. Kaikkien Medela-imupumppujen tavoin tämäkin pumppu takaa luotettavan ja helpon imun. Lisäetuina voidaan pitää helppoa käyttöä ja puhdistusta sekä turvaominaisuuksia. Ota meihin yhteyttä - Annamme mielellämme lisätietoja.

1 Varoitukset ja turvaohjeet



VAROITUKSET

Ilmoittavat mahdollisesta vaaratilanteesta, joka voi johtaa kuolemaan tai vakavaan loukkaantumiseen, ellei sitä vältetä.



HUOMAUTUKSET

Ilmoittavat mahdollisesta vaaratilanteesta, joka voi johtaa lievään tai kohtuulliseen loukkaantumiseen, ellei sitä vältetä.



Turvallisuusvinkki

Viittaa hyödylliseen tietoon laitteen turvallisesta käytöstä.

Clario Toni on hyväksytty käyttöön vain näitä ohjeita noudattaen. Medela voi taata Clario Toni-järjestelmän turvallisuuden vain, kun sitä käytetään alkuperäisten Medela-varusteiden kanssa. Katso kappaleita 17 ja 18.

**Lue nämä varoitukset ja turvaohjeet ennen laitteen käyttöä ja noudata niitä.
Nämä käyttöohjeet on säilytettävä laitteen yhteydessä myöhempää käyttöä varten.**

Huomaa, että nämä käyttöohjeet muodostavat yleisen oppaan tuotteen käyttöön. Lääketieteellisissä asioissa tulee kääntyä lääkärin puoleen.

Medela katsoo olevansa vastuussa Clario Toni-järjestelmän vaikutuksista PERUSTURVALLISUUTEEN, luotettavuudesta ja suorituskyvystä vain, jos sitä käytetään käyttöohjeiden mukaisesti.

HUOMIO: U.S. Liittovaltion lain mukaan tätä laitetta saa myydä vain lääkäri tai lääkärin määräyksestä.

Pidätämme oikeuden muutoksiin.



VAROITUKSET

- Tätä järjestelmää saa käyttää vain lääketieteellisesti koulutettu henkilökunta, joka on saanut riittävän koulutuksen imutoimenpiteisiin ja aspiraattorin käyttöön.
- Niille potilaille, joille laitteen epäkuuntoon joutuminen saattaa aiheuttaa kriittisen tilanteen syntymisen (esim. akuutista hengitysvaikeuksista kärsivät potilaat tai potilaat joilla on voimakas limanmuodostus), on varattava varalaite.
- Laitetta ei saa käyttää räjähtävien, helposti syttyvien tai syövyttävien nesteiden imemiseen.
- Laitteen mukana toimitetut kytkentäletkut eivät saa joutua suoraan kosketukseen imualueen kanssa. Käytä aina steriiliä imukatetria (infektoriski).
- Irrota pistoke kiinteästä pistorasiasta ennen laitteen puhdistamista.
- Tähän laitteeseen ei saa tehdä muutoksia.
- Älä yhdistä passiiviseen huuhteluputkeen.
- Tutustu käyttötarkoituksiin sekä ota huomioon riskitekijät ja vasta-aiheet ennen Clario Toni-järjestelmän käyttöä. Jos tämän käyttöohjeen sisältämiä ohjeita ei lueta ja noudateta ennen käyttöä, seurauksena voi olla potilaan vakava tai kuolemaan johtava loukkaantuminen.
- Älä käytä Clario Tonia magneettikuvausympäristössä (MRI).
- Virtalähde voi vahingoittua, jos 15 kV:n tasavirtaportissa tapahtuu staattisia purkauksia.



HUOMAUTUKSET

- Väärä käyttö saattaa aiheuttaa potilaalle kipua ja vammoja.
- Älä käytä steriilejä lisävarusteita, jos steriili pakkaus on vaurioitunut.
- Langattomat viestintälaitteet, kuten langattomat kotiverkot, matkapuhelimet, langattomat puhelimet tukiasemineen ja radiopuhelimet, voivat vaikuttaa Clario Toniin, ja ne on pidettävä vähintään 30 cm:n päässä laitteesta.
- Siirrettävät ja kannettavat radiotaajuslaitteet (matkapuhelimet) voivat vaikuttaa lääkinnällisiin laitteisiin.



Turvallisuusvinkki

- Turvallisuustesteissä edellytetään, että järjestelmää huolletaan ja korjataan koko käyttöajan huolto-ohjeiden mukaisesti. Suojaluokan II (EN IEC 60601-1, A1, A2:1995) laitteena Clario Toni-järjestelmän turvallisuustestit rajoittuvat kotelon ja sähköjohdon mahdollisten vaurioiden silmämääräiseen tarkistukseen. Nämä tarkistukset on suoritettava ennen jokaista käyttöä.
- Potilaan vuotovirran testaus: katso tarkempia ohjeita huolto-oppaasta.
- Clario Toni-järjestelmän suojaus sydämen defibrillaattorin vaikutuksilta riippuu oikeiden kaapelien käytöstä.
- Laite on kytketty irti verkkovirrasta vasta, kun virtapistoke on irrotettu kiinteästä pistorasiasta.
- Tarkista ennen laitteen kytkemistä sähköverkkoon, että virransyötön jännite on sama kuin tyyppikilvessä ilmoitettu.

Turvaohjeet

- Medela Clario Toni on lääketieteellinen laite, joka vaatii erityisiä turvallisuustoimenpiteitä sähkömagneettisen yhteensopivuuden osalta. Laite on asennettava ja otettava käyttöön siihen kiinnitettyjen EMC-tietojen mukaan.
- Kaikissa seuraavaksi luetelluissa tapauksissa laitetta ei saa ottaa käyttöön, vaan se on annettava huollettavaksi:
 - jos virtajohto tai pistoke on vahingoittunut
 - jos laite ei toimi täydellisesti
 - jos laite on vahingoittunut
 - jos laitteessa on selviä turvallisuuteen vaikuttavia vikoja.
- Pidä virtajohto erossa kuumista pinoista.
- Verkkovirtapistoke ja ON/OFF-kytkin eivät saa joutua kosketuksiin kosteuden kanssa.
- Älä koskaan irrota verkkovirtapistoketta kiinteästä pistorasiasta vetämällä virtajohdosta!
- Älä jätä laitetta valvonnatta, kun se on kytketty päälle.
- Pumpun on oltava käytön aikana suorassa.
- Älä koskaan laita virtajohtoa kaulasi ympärille.
- Laitetta ei saa koskaan käyttää mikäli huonelämpötila on korkea, kylpemisen tai suihkun aikana, väsyneenä tai räjähdysvaaralle alttiissa ympäristössä.
- Laitetta ei saa upottaa veteen tai muuhun nesteeseen.
- Kun käytät steriilejä kertakäyttötuotteita, huomaa, että niitä ei ole tarkoitettu uudelleenkäyttöön. Uudelleenkäyttö saattaisi johtaa mekaanisten, kemiallisten ja/tai biologisten ominaisuuksien häviämiseen. Uudelleenkäyttö voisi aiheuttaa ristikontaminaatiota.
- Ota yhteyttä Medelan asiakaspalvelun edustajaan, jos tarvitset apua tuotteen toimintaan liittyvissä asioissa.
- Käytä kaikissa oloissa käsiaineitä.

Nämä ohjeet on säilytettävä myöhempää käyttöä varten.

2 Virtalähde ja akkukäyttö

Clario Toni on verkkovirta- ja akkukäyttöinen imupumppu. Tarkista ennen laitteen kytkemistä sähköverkkoon, että virransyötön jännite on sama kuin tyyppikilvessä ilmoitettu.

Tämän käyttöoppaan mukaisesti käytettynä Clario Toni AC/DC -mallin maksimikäyttöaika akulla on 50 minuuttia, ennen kuin laite on ladattava uudelleen. Jos Clario Toni AC/DC -mallia ei käytetä, akku on kalibroitava 60–90 vuorokauden välein.

Akun virta vähissä

Akkukäytön aikana LED-merkkivalon hidas vilkkuminen tarkoittaa, että akku on pian tyhjä.

Clario Toni toimii vielä lyhyen ajan (noin 10 minuuttia), mutta akku on ladattava mahdollisimman pian.

Akku tyhjä

Kun akku on tyhjä, pumppu pysähtyy. Pumppu ei enää toimi kunnolla. Akku on ladattava tai vaihdettava.

3 Kuvaus

Johdanto

Clario Toni on korkealuokkainen imupumppu. Se saa virtansa hyväksi havaitusta kalvojärjestelmästä. Siinä yhdistyvät ihanteellisesti helppo käsittely ja puhdistus sekä turvatoiminnot, jotka takaavat optimaalisen toiminnan. Käytä laitetta ainoastaan lääkärin ohjeiden mukaisesti. Noudata myös hoitohenkilökunnalta saamiasi ohjeita.

Käyttötarkoitus

Clario Toni -imulaitteet on tarkoitettu eritteiden, kehon nesteiden ja vieraitten esineiden imemiseen ja poistamiseen potilaan hengitysteistä tai hengityksen tukijärjestelmästä lapsi- ja aikuispotilaiden nenän, kurkunpään ja henkitorven alueelta. Tämä imulaite soveltuu käytettäväksi kotona, sairaalassa, autossa sekä ulkona.

Käyttöaiheet

Clario Toni -imulaite on tarkoitettu hengitysteiden tyhjentämiseen joko nenän, suun tai intubaatioputken kautta.

Vasta-aiheet

Laitte ei sovellu pitkäaikaiseen imemiseen.

Aiottu käyttäjä

Clario Toni-järjestelmää saavat käyttää vain asianmukaisen opastuksen saaneet käyttäjät. Nämä henkilöt eivät saa olla heikkokuuloisia tai kuuroja, ja heillä on oltava riittävä näkökyky. Opastus on uusittava vähintään kerran vuodessa.

Aiottu potilasryhmä

Clario Toni on tarkoitettu käyttöön potilaiden hoidossa vain käyttötarkoituksuvauksen mukaisissa olosuhteissa.

Tärkeä huomautus

Oikeiden leikkaustoimenpiteiden ja tekniikoiden noudattaminen on lääkärin vastuulla. Kunkin lääkärin on arvioitava hoidon oikeellisuus oman tietämyksensä ja kokemuksensa perusteella.

4 Yleiskatsaus

Tyhjiön määrittely

Lääkinnällisen imulaitteen käytössä alipaine annetaan yleensä (absoluuttisina arvoina) absoluuttisen paineen ja ilmanpaineen erotuksena tai negatiivisina arvoina kilopascaleissa (kPa). Tässä dokumentissa esimerkiksi merkintä -10 kPa tarkoittaa aina painealuetta kPa-arvona, joka on pienempi kuin ympäröivä ilmanpaine (standardin EN ISO 10079:1999 mukaan).

Pumpun versiot



Clario Toni AC/DC

Pumpun tärkeimmät osat



Kalvon sijainti



Venttiililaatat turvakammiossa

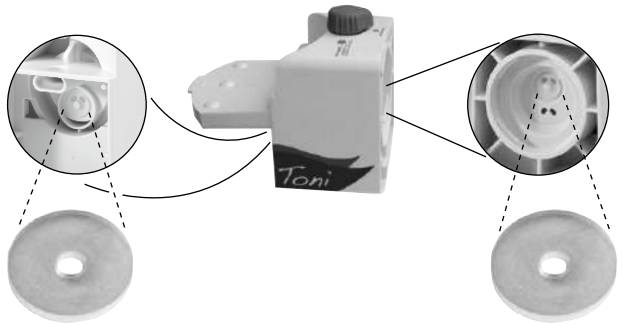

Käyttölaitteet ja akun tila



Imunsäädin

On/off-painike

Akun LED

ei pala Akku on täynnä
palaa – Akkua ladataan
– Pumppu on kytketty

vilkkuu hitaasti Akku on pian tyhjä
vilkkuu nopeasti Akku on viallinen

5 Asennus

Tarkista alkuperäinen toimitus

Tarkista Clario Toni-toimituspakkauksen täydellisyys ja yleinen kunto.



Clario Toni-versiot

REF Clario Toni AC/DC 014.00XX
Clario Toni Deluxe 014.00XX



Kertakäyttöinen sormenpäätetku

REF 074.0003



Verkkovirtaliitin

REF 014.0004

Virtajohto

099.0011 (Euro)
014.0007 (UK)
014.0008 (AUS/NZ)
099.0014 (USA)



Käyttöohjeet

REF 200.8400



VAROITUKSET

Laitteen mukana toimitetut kytkentäletkut eivät saa joutua suoraan kosketukseen imualueen kanssa. Käytä aina steriiliä imukatetria (infektioriski).

6 Käytön valmistelu



VAROITUKSET

Tätä järjestelmää saa käyttää vain lääketieteellisesti koulutettu henkilökunta, joka on saanut riittävän koulutuksen imutoimenpiteisiin ja aspiraattorin käyttöön. Käytä kaikissa oloissa käsineitä.



HUOMAUTUKSET

- Clario Toni-järjestelmän on oltava käytön aikana pystysuorassa.
- Steriilien lisävarusteiden pakkausten eheys on tarkistettava ennen käyttöä.
- Ei-steriilit ja uudelleenkäytettävät lisävarusteet on puhdistettava, desinfioitava ja/tai steriloitava Medelan puhdistusoppaan mukaisesti (tuotekoodi 200.2391).

6.1 Tarkistettavaa ennen käyttöä

- Tarkista Clario Toni-järjestelmä ennen käyttöä virtajohdon tai pistokkeen vaurioitumisen, ilmeisen laitevaurion tai turvallisuusvikojen varalta, ja varmista, että laite toimii asianmukaisesti.
- Tarkista Clario Toni-toimituspakkauksen täydellisyys ja yleinen kunto.
- Varmista, että akku on kalibroitu kappaleen 12 ohjeiden mukaan.
- Tarkista ennen käyttöä kaikki lisävarusteet:
 - Säiliö ja kansi halkeamien sekä hauraiden ja viallisten kohtien varalta. Vaihda tarvittaessa.
 - Letkut halkeamien ja hauraiden kohtien varalta sekä se, että liittimet ovat tukevasti kiinni. Vaihda tarvittaessa.

6.2 Säiliön asennus





1.1 Kiinnitä uimuri säiliöön.

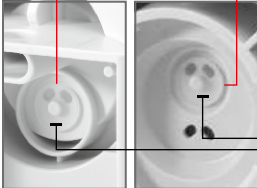

2.1 Kiinnitä kansi säiliöön. Huomioi merkinnät säiliön etuosassa ja kannessa.

6.3 Turvakammion asennus

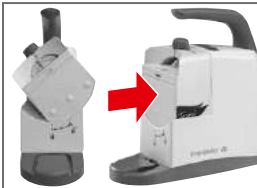
1.  1.1 Avaa turvakammion kansi.
2.  2.1 Varmista, että molemmat venttiilit (silikonilevyt) on kiinnitetty turvakammioon. Katso kappaletta 4.
3.  3.1 Varmista, että turvakammion kansi on suljettu kunnolla.
4.  4.1 Pidä kiinni turvakammioista ja kallista sitä 45° vasemmalle, jotta voit kiinnittää sen moottoriyksikköön.
4.2 Käännä turvakammio pystyyn, niin että kuulet napsahduksen.

6.4 Säiliön kiinnittäminen pumppuun

1.  1.1 Kiinnitä säiliö pumppuun. Paina lujasti.
2.  2.1 Kiinnitä kertakäyttöinen sormenpääletku imuaukkoon.

7 Käyttöohjeet



HUOMAUTUKSET

Clario Toni on asennettava siten, että verkkovirrasta erottaminen onnistuu helposti. Kalibroi akku ennen ensimmäistä käyttökertaa.



VAROITUKSET

Tätä järjestelmää saa käyttää vain lääketieteellisesti koulutettu henkilökunta, joka on saanut riittävän koulutuksen imutoimenpiteisiin ja aspiraattorin käyttöön. Käytä kaikissa oloissa käsineitä.

7.1 Kytke Clario Toni verkkovirtaan

1. Tarkista pumppu ennen käyttöä kappaleen 6.1 ohjeiden mukaan.

2. **Kaikki mallit: jos pumppu on kytketty kiinteään pistorasiaan:**

Kytke virtajohdon pistoke kiinteään pistorasiaan.

tai

Jos pumppua käytetään 12 V:n tasavirtalähteellä:

Kytke lisävarusteena hankittava 12 V:n tasavirtaliitäntäjohto pumppuun ja 12 V:n tasavirtalähteeseen.

tai

Jos pumppua käytetään akulla:

Liitäntää virtalähteeseen ei tarvita. Varmista, että akkua on ladattu viiden tunnin ajan.

7.2 Toiminnan tarkistaminen vedellä

1.

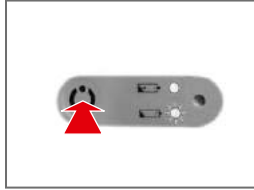

1.1 Käynnistä pumppu painamalla on/off-painiketta.

2.

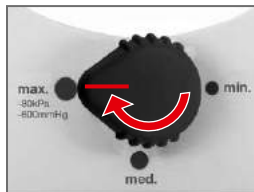

2.1 Käännä imunsäädin „max“-asentoon.

3.

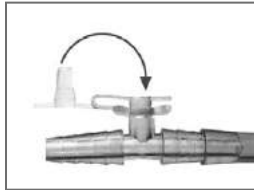

3.1 Kiinnitä sormenpääletku. Katso kappale 6.4, vaihe 2.1.
3.2 Kytke sormenpääportti.

4.

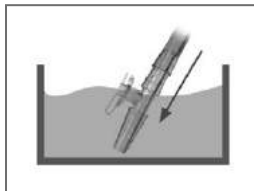

4.1 Aseta letku veteen ja tarkasta imuteho.

5. Jos imua on, jatka vaiheesta 6. Ellei, katso kappaletta 13.

6. Käytä lääkärin määräämää katetria ja imuasetusta.

7.3 Vaihtoehto: toimintojen tarkistus lisävarusteena saatavalla mittarilla

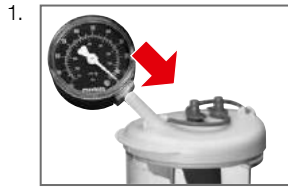

1.1 Kiinnitä imuaukkoon lisävarusteena hankittava tyhjiömittari.

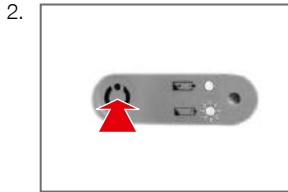

2.1 Käynnistä pumppu painamalla on/off-painiketta.

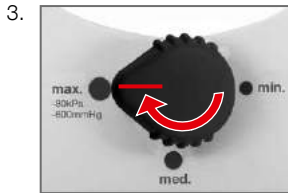

3.1 Aseta imunsäädin „max“-asentoon.



4.1 Vertaa imutehoa vasemmalla olevan taulukon arvoihin.

Korkeus merenpinnasta:	Maksimi-imuteho:
+ 2000 m	- 63 kPa - 471 mmHg
+ 1000 m	- 71 kPa - 532 mmHg
+ 500 m	- 76 kPa - 566 mmHg
0 m	- 80 kPa - 600 mmHg

(Toleranssi: - 15 %)

5. Jos imuteho on ok, jatka vaiheesta 6. Ellei, katso kappaletta 13.

6. Kiinnitä sormenpääletku.

7. Käytä lääkärin määräämää katetria ja imuasetusta.



VAROITUKSET

Tätä järjestelmää saa käyttää vain lääketieteellisesti koulutettu henkilökunta, joka on saanut riittävän koulutuksen imutoimenpiteisiin ja aspiraattorin käyttöön. Käytä kaikissa oloissa käsineitä.

7.4 Tyhjiötason muuttaminen

1.

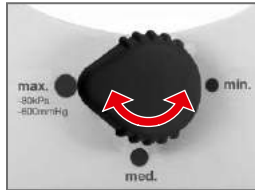

1.1 Aseta imunsäädin tarvittavaan asentoon.

7.5 Käytöstä poistaminen käytön jälkeen

1.

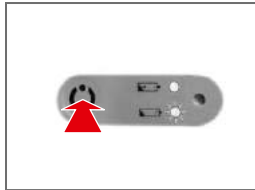

1.1 Sammuta pumppu painamalla on/off-painiketta.

2. Jos pumppu on kytketty kiinteään pistorasiaan:

Irrota verkkovirtapistoke kiinteästä pistorasiasta.

tai

Jos pumppu on kytketty 12 V:n tasavirtalähteeseen:

Irrota 12 V:n tasavirtapistoke 12 V:n tasavirtalähteestä.

3. Puhdista ja desinfioi Clario Toni. Katso kappaletta 16.

8 Säiliön tyhjentäminen



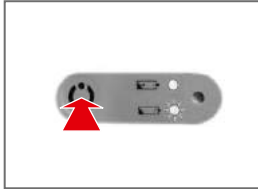

Turvallisuusvinkki

Säiliö tulee tyhjentää päivittäin tai viimeistään, kun nesteen taso saavuttaa 550 ml ja uimuri lopettaa imun säiliöön.

- 

1.1 Sammuta pumppu painamalla on/off-painiketta.
- 

2.1 Irrota kertakäyttöinen sormenpääletku imuaukosta.
2.2 Irrota säiliö pumpusta.
- 

3.1 Sulje säiliö aina tulpilla kuljetusta varten.
4. Tyhjennä säiliö ja hävitä sormenpääletku paikallisten ja sairaalan omien ohjeiden mukaisesti.
- 

5.1 Kiinnitä puhdas säiliö.
5.2 Kiinnitä imuaukkoon uusi kertakäyttöinen sormenpääletku.
6. Käynnistä pumppu ja aseta lääkärin määräämä imuteho.

9 Venttiililaattojen vaihtaminen

1.



1.1 Irrota säiliö.

2.

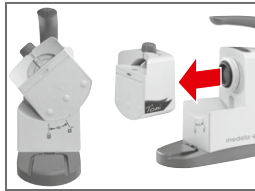

2.1 Käännä turvakammiota 45° vasemmalle.

2.2 Irrota turvakammio vetämällä se irti pumpusta.

3.



3.1 Avaa turvakammio.

4.

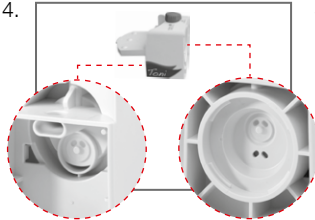

4.1 Vaihda vialliset venttiililaatat. Varmista, että uudet venttiililaatat kiinnitetään oikein.

5. Kiinnitä turvakammio pumppuun kappaleen 6.3 ohjeiden mukaisesti.

10 Akun vaihtaminen



VAROITUKSET

Ennen kuin vaihdat akun, kytke Clario Toni pois päältä ja irrota Clario Tonin verkkovirtapistoke kiinteästä pistorasiasta.



Irrota ennen tätä verkkovirtapistoke kiinteästä pistorasiasta.

1.

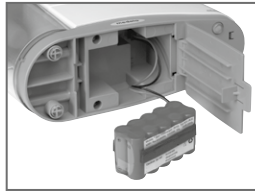

1.1 Avaa Clario Tonin pohjassa olevan akkulokeron kansi.

2.

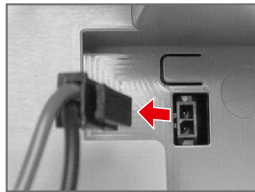

2.1 Irrota akun johto vetämällä pistoke irti.

3. Irrota vanha akku.

4. Aseta uusi akku tilalle.

5.

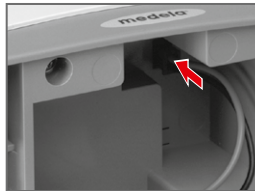

5.1 Kiinnitä akun johto uudelleen kytkemällä pistoke pistorasiaan.

6. Sulje akkulokeron kansi. Varmista, että kansi on suljettu tiiviisti eikä akun johto ole puristuksissa tai litistettynä.

7. Kalibrooi ja testaa akku (katso kappaleita 11 ja 12).

11 Akun tiedot ja testaus



HUOMAUTUKSET

Lataa akku vain, kun latausmerkkivalo vilkkuu hitaasti.

Pumppauksen kesto

Jos akku on ladattu täyteen, käyttöaika maksimi-imuteholla on noin > 50 minuuttia.

Latausaika (100-prosenttisesti ladattu)

Noin 5 tuntia

Akun tila

ei pala	Akku on täynnä
palaa	– Akkua ladataan – Pumppu on kytketty
vilkkuu hitaasti	Akku on pian tyhjä
vilkkuu nopeasti	Akku on viallinen

Akun testaaminen

1. Varmista, että akku on täynnä.
2. Irrota verkkovirtapistoke kiinteästä pistorasiasta.

3.  3.1 Aseta imunsäädin „max“-asentoon.

4.  4.1 Käynnistä Clario Toni. Pumppu käynnistyy.

5. Mittaa aika siihen asti, kun pumppu pysähtyy. Akku on kunnossa, kun käyntiaika on > 50 minuuttia.

Jos käyntiaika on < 50 minuuttia, toista testi tai kalibroi akku (ks. seuraava sivu).

12 Akun kalibrointi



HUOMAUTUKSET

Kalibroi akku ennen ensimmäistä käyttökertaa ja kun varastointiaika > 2 kuukautta. Vaihda akku, jos kalibrointi ei onnistu.

NiMH-akun kalibrointi

1. Varmista, että akku on täynnä.

2. Irrota verkkovirtapistoke kiinteästä pistorasiasta.

3.

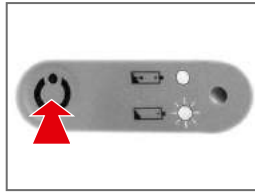

3.1 Käynnistä Clario Toni.
Pumppu käynnistyy.

4. Anna pumpun käydä, kunnes akku on tyhjä ja pumppu pysähtyy.

5. Kytke Clario Toni kiinteään pistorasiaan.
Akkua ladataan.

6. Odota, kunnes latauksen merkkivalo sammuu.

7. Toista vaiheet 1–6. Clario Toni AC/DC on silloin käyttövalmis.

Akun säilytys

Minimoi akun tyhjeneminen itsestään säilyttämällä Clario Tonia ja poistettuja ladattavia vara-akkuja alle 25 °C:n lämpötilassa. Toista kalibrointi 60–90 vuorokauden välein.

13 Vianetsintä

Moottori ei käynnissä

Tarkista:

- onko Clario Toni kytketty päälle.
- että verkkovirta on oikea ja verkkovirtapistoke kytketty oikein kiinteään pistorasiaan.
- että sisäinen akku on latautunut.

Pumppu on liian äänekäs

Tarkista turvakammion sisällä olevien venttiililaattojen paikat ja tiiviys.

Riittämätön imuteho

Tarkista:

- että imunsäädin on säädetty oikein.
- etteivät letkut ole viallisia tai rikki. Vaihda tarvittaessa.
- että kaikki pistokeliitännät ovat tiiviitä.
- ettei imusäiliössä/kannessa ole halkeamia, hauraita kohtia tai värjäytymiä. Vaihda tarvittaessa.
- että turvakammion sisällä olevat venttiililaatat ovat tiiviitä.
- että kalvo on puhdas eikä siinä ole repeämiä.

Käyntiaika akulla riittämätön

Kalibroi akku. Katso kappaletta 12.

LED-valo ei pala

Akku on täynnä.

LED palaa

- Akkua ladataan.
- Pumppu on kytketty.

LED vilkkuu hitaasti

Akku on kohta tyhjä. Akun virta riittää noin 10 minuuttia kestävään pumppaukseen.

LED vilkkuu nopeasti

Akku on viallinen. Katso ohjeet viallisen akun vaihtamiseen kappaleesta 10.

14 Takuu ja huolto

Takuu

Medela AG myöntää laitteelle takuun materiaali- ja valmistusvirheiden varalta 2 vuoden ajaksi (akulle 6 kuukauden ajaksi) toimituspäivästä lukien. Vialliset materiaalit vaihdetaan tänä aikana veloituksetta, ellei vika ole seurausta virheellisestä käytöstä tai väärinkäytöstä. Tämä ei koske normaalisti kuluvia osia. Tämän takuun mukaisuuden ja Medela-tuotteiden optimaalisen huollon varmistamiseksi suosittelemme Medela-lisävarusteiden käyttöä ainoastaan valmistamiemme laitteiden kanssa.

Medela AG ei missään tapauksessa vastaa vahingoista, jotka ylittävät takuun kuvatus laajuuden, mukaan lukien vastuu välillisistä vahingoista jne. Medela ei myönnä oikeutta viallisten osien vaihtoon, jos pumppuun on teetetty huolto- tai korjaustöitä henkilöillä, joilla ei ole siihen valtuuksia. Tämä takuu edellyttää laitteen palauttamista Medelan valtuuttamaan huoltoliikkeeseen.

Huolto

Vain Medelan valtuuttamat huoltoliikkeet saavat suorittaa huoltotoimenpiteitä. Medelan huoltokäsikirjan voi tilata Medelalta.

15 Hävittäminen

Clario Toni-järjestelmä koostuu metalli- ja muoviosista, ja sen hävittäminen on suoritettava Euroopan unionin direktiivien 2011/65/EY ja 2012/19/EY mukaisesti. Täydentäviä paikallisia ohjeita tulee noudattaa. AC/DC-versioiden elektroniikkakomponentit ja akku on hävitettävä erikseen paikallisten määräysten mukaisesti.

Hävitä Clario Toni ja sen lisävarusteet paikallisten jätehuolto-ohjeiden mukaisesti.



Ohjeet sähkö- ja elektroniikkalaitteiden hävittämistä varten

Tämä symboli tarkoittaa, että sähkö- ja elektroniikkalaitteita ei saa hävittää normaalina kotitalousjätteenä. Tämän laitteen oikealla hävittämisellä suojellaan ympäristöä tai ihmisten terveyttä ja estetään niille aiheutuvia vahinkoja. Lisätietoja hävittämisestä saat valmistajalta, paikallisesta jätehuolto-yhtiöstä tai terveydenhuoltopalvelujen tarjoajalta. Tämä symboli on voimassa vain Euroopan unionissa. Noudata maasi sähkö- ja elektroniikkalaitteiden hävittämistä koskevia kansallisia lakeja ja sääntöjä.

16 Puhdistusohjeet



VAROITUKSET

Jokaisen käytön jälkeen imettyjen eritteiden kanssa kosketuksissa olleet osat on puhdistettava, desinfioitava, steriloitava tai hävitettävä seuraavan sivun taulukon mukaisesti.



Irrota verkkovirtapistoke kiinteästä pistorasiasta ennen laitteen puhdistamista.

Yleisiä huomautuksia

- Nämä ovat vain yleisiä huomautuksia, joita voidaan muokata yksilöllisesti sairaalan erityisohjeiden, puhdistuskäytäntöjen ja toimintaohjeiden mukaisesti.
- Yksityiskohtaiset tiedot Medelan puhdistusohjeiden (tuotekoodi 200.2391) mukaan.
- Käytä puhdistuksessa/desinfiointissa suojakäsineitä.
- Hävitä nesteet, kuten veri ja eritteet, sekä niistä kontaminoituneet osat sairaalan sisäisten ohjeiden mukaisesti.

Medelan suosittelemat pintapuhdistusaineet pumpun kotelolle

- **CaviWipes**, Metrex Research, www.sybrondental.com
- **mikrozyd® AF wipes**, Schülke&Mayr GmbH, www.schuelke.com

Vesi

Käytä puhdistukseen ainoastaan puhtainta vettä. Veden kovuus on vakava ongelma, koska lääkinnällisiin tuotteisiin jäävät jäämät eivät välttämättä puhdistu kokonaan. Käytä deionoitua vettä tämän ongelman pienentämiseksi. Loppuhuuhteluvesi on bakteeritonta eikä sisällä endotoksiineja.

Puhdistus-/desinfiointilaitteet

Voidaan käyttää seuraavan sivun taulukon mukaisten osien desinfiointiin. Huuhtelu kuumalla vedellä (maksimilämpötila 100 °C) voi muodostaa keskitason tai korkean tason desinfiointin. Osien joka kohtaan on yllettävä tehokkaan puhdistuksen varmistamiseksi. Suosittelemme Robert Koch -insituutin hyväksymän ja standardin ISO 15883 mukaisen puhdistus-/desinfiointilaitteen käyttöä. Ei-kriittisille lääkinnällisille laitteille (eli ainoastaan vaurioitumattomaan ihoon koskettaville laitteille) suositeltava lämpötila on 90 °C 1 minuutin ajan. Aika pidennetään 5 minuuttiin kriittisiksi katsottujen lääkinnällisten laitteiden osalta.



Kertakäyttötuotteet

Nämä ovat kertakäyttötuotteita, joita ei ole tarkoitettu uudelleenkäsiteltäviksi. Uudelleen käsittely aiheuttaa mekaanisten, kemiallisten ja/tai biologisten ominaisuuksien häviämistä. Uudelleenkäyttö voisi aiheuttaa ristikontaminaatiota.

Säiliö, turvakammio	Pumpun kotelo Verkkovirtajohto	
x	x	1. Purkaminen Irrota kaikki yksittäiset osat ennen puhdistusta, desinfiointia ja sterilointia.
x		2. Puhdistussäiliö, turvakammio Puhdista osat kuumassa vedessä (60–70 °C), johon on lisätty pesuainetta, jonka pH-arvon on oltava 6,0–8,0, etteivät instrumentit ja suojalaitteet vaurioitu. Entsymaattiset puhdistusaineet auttavat orgaanisten aineiden, esim. veren poistamisessa. Puhdistusaineita tulee käyttää valmistajan suosittelemia pitoisuuksia noudattaen. Jotkin alkaliset puhdistusaineet on suunniteltu turvallisiksi lääkinällisten laitteiden uudelleen käsittelyssä. Näiden puhdistusaineiden valmistajien tulee ilmoittaa, mihin materiaaleihin puhdistusaineista voi aiheutua vaurioita. Upota kaikki osat huolellisesti lämpimään saippuaveteen tai entsyymattiseen puhdistusaineeseen 1–5 minuutin ajaksi. 1. Poista näkyvä lika puhdistustyökälulla – yleiskäyttöön tarkoitettulla puhdistusharjalla, kuten piipunpuhdistimella tai hankaamattomalla pölyliinalla. Harjojen ja piipunpuhdistimien tulee sopia aukkoon tiiviisti, mutta niitä on pystyttävä liukuttamaan helposti puhdistettavalla alueella. Huuhtelee huolellisesti puhtaalla vedellä. Anna kuivua. 2. Tarkista instrumentit näkyvän lian varalta ja toista nämä vaiheet tarvittaessa.
	x	3. Pumpukotelon, verkkojohdon puhdistaminen Pyyhi edellä mainitulla puhdistusaineella. Kuivaa puhtaalla liinalla.
x		4. Desinfiointi Upota huoneenlämpötilassa 30 minuutiksi desinfiointi-/puhdistusliuokseen (A). Kun reaktioaika on kulunut, huuhtelee liuosjäämät vedellä yksittäisistä osista ja huuhtelee letkut. Huuhtelee ainakin 2 minuutin ajan puhdistusliuoksella (B). (A) ohut aldehydivapaa puhdistava desinfiointiliuos käytettäväksi liotusaineena, bakteerien ja sienten sekä rajoitetusti virusten torjunta-aineena, hyvä materiaaliyhteensopivuus ruostumattoman teräksen, ei-rautamateriaalien ja erilaisten muovien, kuten silikonin kanssa, miedosti emäksinen, esim. 2 % neodisher® Septo MED -liuos. (B) ohut, pH-neutraali, entsyymattinen puhdistusneste instrumenttien käsittelyyn koneella tai käsin, erittäin hyvä materiaaliyhteensopivuus ruostumattoman teräksen, ei-rautamateriaalien ja muovien, kuten silikonien kanssa. tai käytä puhdistus-/desinfiointilaitetta. tai käytä astianpesukonetta.
x		5. Komponenttien säilytys Säilytä komponentit desinfiointin jälkeen puhtaana ja kuivana liinan päällä.

17 Yleiskuva lisävarusteista



VAROITUKSET

Clario Toni on hyväksytty yhdessä alla mainittujen lisävarusteiden kanssa. Laite toimii oikein ja turvallisesti vain näiden lisävarusteiden kanssa. Lisätietoja on kyseisen lisävarusteen ohjeissa.

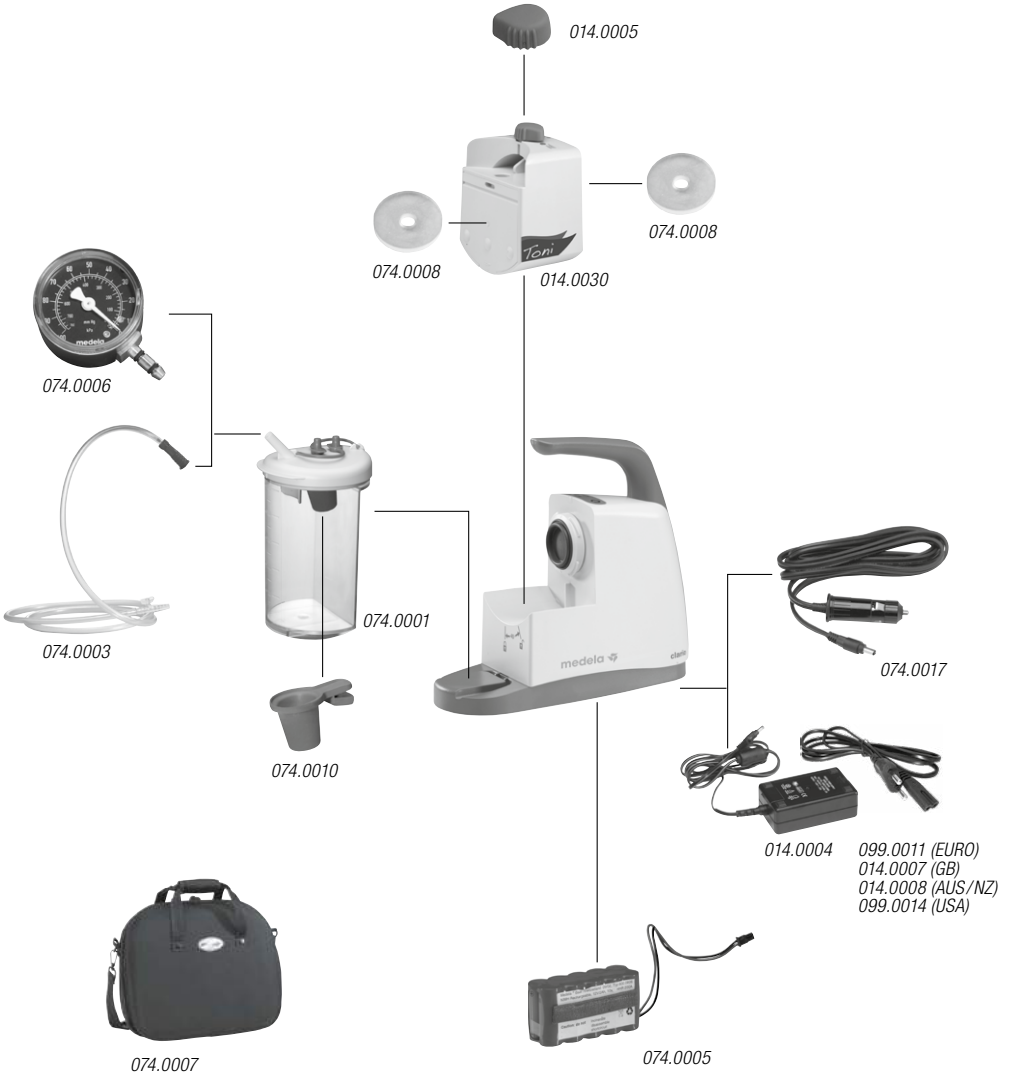

18 Lisävarusteiden kuvateksti



Turvallisuusvinkki

Jos pumppua käytetään muiden kuin Medelan valmistamien osien kanssa, niille asetetaan seuraavat vaatimukset:

- CE-merkintä ja (tarvittaessa) paikallinen rekisteröinti.
- turvallinen kiinnitys Medelan lisävarusteisiin pumpun suorituskykyyn vaikuttamatta.

Huomaa: Medelan ja muiden valmistajien osia yhdistäessäsi otat vastuun koko järjestelmästä.

REF

- 014.0030 Turvakammio
- 014.0005 Imunsäädin
- 074.0008 Venttiililaatat (10 kpl)
- 074.0001 Imupurkkisarja
- 074.0010 Uimuri (10 kpl)
- 074.0003 Kertakäyttöinen sormenpäätetku
- 074.0005 Uudelleenladattava akku
- 014.0004 Verkkovirtaliitin
- 099.0011 Virtajohto (EURO)
- 099.0014 Virtajohto (USA)
- 014.0007 Virtajohto (GB)
- 074.0007 Kantokassi
- 074.0017 12 V DC liitântäkaapeli autokäyttöä varten
- 074.0006 Tyhjiömittari

19 Merkit ja symbolit



Tämä symboli tarkoittaa lääkinällisistä laitteista 14. kesäkuuta 1993 annetun neuvoston direktiivin 93/42/ETY olennaisten vaatimusten mukaisuutta.



Tämä symboli tarkoittaa pumpun luokkaa.



Tämä symboli viittaa luokan II laitteeseen.

IP21

Tämä symboli viittaa suojaukseen vieraiden esineiden ja veden sisään pääsyn haittavaikutuksilta.



Tämä symboli tarkoittaa, että laitetta ei saa käyttää merkityn vuoden ja kuukauden lopun jälkeen.



Tämä symboli tarkoittaa kertakäyttöistä laitetta. Älä käytä laitetta uudelleen.



Tämä symboli viittaa Yhdysvaltojen lääkinällisiä sähkölaitteita koskevien turvallisuusvaatimusten noudattamiseen.



Tämä symboli tarkoittaa BF-tyyppistä osaa.

REF

Tämä symboli tarkoittaa valmistajan luettelon numeroa.

SN

Tämä symboli viittaa valmistajan sarjanumeroon.



Tämä symboli viittaa pumpun laillisiin spesifikaatioihin.



Tämä symboli tarkoittaa EI TURVALLINEN MAGNEETTIRESONANSSIN YHTEYDESSÄ.

LOT

Tämä symboli viittaa valmistajan eräkoodiin.



Tämä symboli viittaa käyttöohjeiden noudattamiseen.



Tämä symboli tarkoittaa, että tällä symbolilla merkityn laitteen lähistöllä voi ilmetä häiriöitä.

STERILEEO

Tämä symboli tarkoittaa, että laite on steriloitu eteenioksidin avulla.



Tämä symboli viittaa käyttöohjeiden noudattamiseen.



Tämä symboli tarkoittaa valmistajaa.



Tämä symboli tarkoittaa käytön, kuljetuksen ja säilytyksen aikaista lämpötilarajoitusta.



Tämä symboli viittaa laitteeseen liittyvään HUOMAUTUKSEEN tai VAROITUKSEEN.



Tämä symboli ilmoittaa valmistusajankohdan (vuosi neljällä ja kuukausi kahdella numerolla).



Tämä symboli viittaa käytön, kuljetuksen ja säilytyksen aikaiseen kosteusrajoitukseen.



Tämä symboli viittaa turvallisuusvinkkiin.



Tämä symboli tarkoittaa käytön, kuljetuksen ja säilytyksen aikaista ilmanpainerajoitusta.



Tämä symboli tarkoittaa, että laitetta ei saa käyttää, jos pakkaus on vaurioitunut.



Tämä symboli viittaa tuotteiden lukumäärään n, jolle sisältö riittää.



Tämä symboli tarkoittaa, ettei laitetta saa hävittää yhdessä lajittelemattoman yhdyskuntajätteen kanssa (koskee vain EU:ta).



Tämä symboli tarkoittaa, että materiaali on osa uudelleenkäyttö-/kierrätysprosessia.



Tämä symboli tarkoittaa pahvipakkausta.



Tämä symboli tarkoittaa, että laite on pidettävä poissa auringonpaisteesta.



Tämä symboli tarkoittaa, että herkästi rikkoutuvaa laitetta on käsiteltävä varovasti.



Tämä symboli tarkoittaa laitteen pitämistä kuivana.



Tämä symboli tarkoittaa pumpun maksimi-imutehotasoa.



Tämä symboli viittaa pumpun virtaustasoihin.



Tämä symboli viittaa pumpun sähkötietoihin.



Tämä symboli tarkoittaa vaihtovirtaa.



Tämä symboli tarkoittaa tasavirtaa.



Tämä symboli viittaa pumpun painoon.



Tämä symboli tarkoittaa pumpun mittoja (k x l x s).



Tämä symboli tarkoittaa lääkärin määräyksestä käytettävää laitetta. HUOMIO: U.S. Yhdysvaltain liittovaltion lain mukaan tätä laitetta saa myydä vain lääkäri tai lääkärin määräyksestä (koskee vain Yhdysvaltoja).



Tämä symboli tarkoittaa tuotteiden lukumäärää.

20 Tekninen erittely



min.imuteho, - 70 mmHg / - 9 kPa (+/- 20 mmHg / +/- 2.6 kPa)
keski-imuteho, - 115 mmHg / - 15 kPa (+/- 30 mmHg / +/- 4 kPa)
maks.imuteho, - 600 mmHg / - 80 kPa (- 90 mmHg / - 12 kPa)

Laskettu 0 metrin kohdalla, ilmanpaine: 1013 hPa
Huomaa: imuteho voi vaihdella sijainnin mukaan
(metrejä merenpinnan yläpuolella, ilmanpaine ja lämpötila).



pieni virtaus: 15l/min. (+/- 10%)



2,0 kg / 4,4 lbs
Ilman säiliötä



100-240 V, 50-60 Hz
12 V, 3,4 A, NiMH
Verkkovirtaliitin
UE48-120340SPA1



ISO 13485
93/42 ETY, luokka IIa



k x l x s
223x255x95 mm

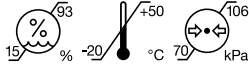

Kuljetus-/säilytysolosuhteet



Kuljetus/säilytys
Uudelleenladattava akku

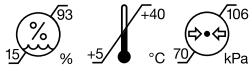

Käyttöolosuhteet



IP21

21 Tekninen dokumentaatio



VAROITUKSET

Älä käytä muita lisävarusteita kuin valmistajan määrittämiä tai myymiä sisäisten komponenttien varaosia, sillä se saattaa lisätä Clario Toni-pumpun päästöjä tai heikentää sen häiriödensietoa.

Kirurgiset korkeataajuuslaitteet, radioverkot tai vastaavat voivat vaikuttaa laitteen toimintaan, eikä niitä saa käyttää yhdessä Clario Tonin kanssa.

EMC

Clario Toni on EMC-testattu ja täyttää standardien IEC 60601-1-2:2007 ja IEC 60601-1-2:2014, 4. versio, vaatimukset kohtien 7 ja 8.9 mukaisesti. Clario Toni on lääketieteellinen laite, joka vaatii erityisiä turvallisuustoimenpiteitä, ja se on asennettava ja otettava käyttöön oheisten sähkömagneettista yhteensopivuutta koskevien ohjeiden mukaisesti.

Katso myös sivut 326–329.

Innhold

Gratulerer	228
1 Advarsler og sikkerhetsinstrukser	229
Sikkerhetsinstrukser	231
2 Strømforsyning og batteridrift	232
Lavt batterinivå	232
Utladet batteri	232
3 Beskrivelse	233
Innledning	233
Tiltent bruk / indikasjoner	233
Kontraindikasjoner	233
Tiltent bruker	233
Tiltent pasientgruppe	233
Viktig merknad	233
4 Oversikt	234
Definisjon av vakuum	234
Versjoner av pumpen	234
Pumpens hovedelementer	234
Membranens plassering	235
Ventilskiver i sikkerhetskammeret	235
Driftselementer og batteristatus	235
5 Installasjon	236
Kontroll av leveranse	236
6 Klargjøring for bruk	237
Kontroller før bruk	237
Montering av flasken	237
Montering av sikkerhetskammeret	238
Koble flasken til pumpen	238
7 Instruksjoner for bruk	239
Koble Clario Toni til strømmettet	239
Funksjonskontroll med vann	240
Alternativ: funksjonskontroll med vakuummåleren (tilleggsutstyr)	241
Endre vakuumnivå	242
Ta ut av drift etter bruk	242
8 Tømme flasken	243
9 Skifte ventilskivene	244

10 Skifte det oppladbare batteriet	245
11 Batteridata og -test	246
Pumpetid.....	246
Ladetid (100 % lading).....	246
Batteristatus.....	246
Teste det oppladbare batteriet.....	246
12 Kalibrere batteriet	247
Kalibrere det oppladbare NiMH-batteriet.....	247
Oppbevaring av det oppladbare batteriet.....	247
13 Feilsøking	248
Motoren går ikke.....	248
Mye støy fra pumpen.....	248
Utilstrekkelig vakuüm.....	248
Batteriets driftstid er for kort.....	248
Ingen LED-lampe tent.....	248
LED-indikator tent.....	248
LED-indikator blinker langsomt.....	248
LED-indikator blinker raskt.....	248
14 Garanti og service	249
Garanti.....	249
Service.....	249
15 Kassering	249
16 Retningslinjer for rengjøring	250
Generelle merknader.....	250
Medela-anbefalte overflatevaskemidler til rengjøring av pumpehuset.....	250
Vann.....	250
Vaske-/desinfeksjonsmaskiner.....	250
Engangsprodukter.....	250
17 Tilbehørsoversikt	252
18 Tilbehørsforklaring	253
19 Skilt og symboler	254
20 Tekniske spesifikasjoner	256
21 Teknisk dokumentasjon	257
Teknisk dokumentasjon/EMC.....	326

Gratulerer

Ved å velge Clario Toni har du anskaffet en sugepumpe av høy kvalitet, som kan tilpasses til dine behov kun etter anvisning av medisinsk personell. Dette produktet tilbyr deg enkel håndtering, enkel rengjøring og optimal sikkerhet mot overløp. Det fungerer ved hjelp av et membransystem med en elektrisk motor. Sugekraften kan innstilles til ønsket nivå med de tre vakuuminstillingene. Som alle sugepumper fra Medela, gir denne pumpen pålitelig og enkel suging. Den er lett å håndtere og rengjøre, og har gode sikkerhetsfunksjoner. Kontakt oss – vi hjelper deg gjerne.

1 Advarsler og sikkerhetsinstruksjer



ADVARSLER

Indikerer en potensielt farlig situasjon, som kan føre til død eller alvorlig personskade hvis den ikke unngås.



FORSIKTIG

Indikerer en potensielt farlig situasjon, som kan føre til mindre eller moderate personskader hvis den ikke unngås.



Sikkerhetstips

Indikerer nyttig informasjon om sikker bruk av apparatet.

Clario Toni er kun godkjent for bruk som beskrevet i denne bruksanvisningen. Medela garanterer ikke trygg drift av systemet dersom Clario Toni ikke brukes i kombinasjon med Medela-tilbehør. Se kapittel 17/18.

Vennligst les og ta hensyn til disse advarslene og sikkerhetsinstruksene før bruk. Denne bruksanvisningen skal oppbevares sammen med apparatet for senere bruk.

Vær oppmerksom på at denne bruksanvisningen er en generell veiledning til bruk av produktet. Medisinske spørsmål skal alltid avgjøres av lege. Medela er bare ansvarlig for Clario Toni-apparatets virkning når det gjelder GRUNNLEGGENDE SIKKERHET, pålitelighet og ytelse hvis det brukes i samsvar med denne bruksanvisningen.

FORSIKTIG: USA Føderale lover begrenser salg og bruk av dette apparatet til eller etter ordre fra lege.

Betingelsene kan bli endret.



ADVARSLER

- Skal bare brukes av medisinsk personell som har fått tilstrekkelig opplæring i oppsugingsprosedyrer og bruk av aspiratorer.
- For pasienter der utfall av apparatet kan føre til en kritisk situasjon (f.eks. pasienter med akutte pustevansker eller sterk slimdannelse) må et reserveapparat alltid stå klart.
- Apparatet må ikke brukes til oppsuging av eksplosjonsfarlige, lettantennelige eller etsende væsker.
- Tilkoblingsslangen som leveres med apparatet, må ikke komme i direkte kontakt med oppsugingsområdet. Det må alltid brukes sterilt sugekateter (fare for infeksjon).
- Trekk støpselet ut av stikkkontakten før apparatet rengjøres.
- Det er ikke tillatt å foreta endringer på dette utstyret.
- Dette apparatet må ikke kobles til en passiv dreneringsslange.
- Se indikasjoner for bruk og ta hensyn til risikofaktorer og kontraindikasjoner før bruk av Clario Toni. Hvis ikke alle instruksjoner i denne bruksanvisningen er lest og fulgt for bruk, kan det føre til alvorlig eller dødelig skade på pasienten.
- Clario Toni må ikke brukes i MRI-miljøer (Magnetic Resonance Imaging).
- Strømforsyningen kan bli skadet når det oppstår elektriske utladninger (ESD) i likestrømsporten på 15 kV.



FORSIKTIG

- Feil bruk kan forårsake smerter og skader hos pasienten.
- Bruk ikke sterilt tilbehør hvis den sterile emballasjen er skadet.
- Trådløst kommunikasjonsutstyr som trådløse hjemmenettverk, mobiltelefoner, trådløse telefoner og deres basestasjoner samt walki-talkie kan påvirke Clario Toni og bør holdes minst 30 cm unna utstyret.
- Bærbart og mobilt RF-kommunikasjonsutstyr kan påvirke medisinske apparater.



Sikkerhetstips

- Det forutsettes for sikkerhetstester at apparatet vedlikeholdes og repareres gjennom hele levetiden i samsvar med serviceinstruksjonene. Siden Clario Toni er et apparat i sikkerhetsklasse II (EN IEC 60601-1, A1, A2:1995), er sikkerhetstestene begrenset til visuell kontroll av kabinettet og strømledningen. Denne testen må gjennomføres for hver bruk.
- Teste pasientlekkasjestrøm: Se servicehåndboken for detaljer.
- Beskyttelse av Clario Toni mot utladningsvirkningen av en hjertedefibrillator avhenger av at det brukes egnede kabler.
- Dra støpselet ut av stikkkontakten for å være sikker på at apparatet er koblet fra strømmettet.
- Før du kobler apparatet til strømmettet, må du kontrollere at spenningen i det lokale strømmettet er den samme som den som er oppgitt på spesifikasjonsplaten.

Sikkerhetsinstrukser

- Medela Clario Toni er et medisinteknisk apparat som er betinget av spesielle sikkerhetstiltak i forhold til EMK. Det må installeres og settes i drift i samsvar med den vedlagte EMK-informasjonen.
- I følgende tilfeller skal apparatet ikke tas i bruk, og det skal repareres av kundeservice:
 - hvis strømledningen eller støpselet er ødelagt
 - hvis apparatet ikke fungerer normalt
 - hvis apparatet er ødelagt
 - hvis apparatet har tydelige sikkerhetsfeil.
- Hold strømkabelen unna varme overflater.
- Støpselet og på/av-bryteren må ikke komme i kontakt med fuktighet.
- Ikke dra støpselet ut av kontakten til strømmettet ved å dra i strømkabelen!
- La ikke apparatet være uten tilsyn når det er slått på.
- Under bruk må pumpen stå oppreist (vertikalt).
- Legg aldri strømledningen rundt halsen.
- Bruk ikke apparatet ved høy romtemperatur, ved bading eller dusjing, når du er svært trett eller i eksplosjonsfarlige omgivelser.
- Sett aldri apparatet i vann eller andre væsker.
- Ved bruk av sterile produkter for engangsbruk må det legges merke til at produktene ikke er ment for etterbehandling. Etterbehandling kan føre til at produktene mister sine mekaniske, kjemiske og/eller biologiske egenskaper. Gjenbruk kan føre til krysskontaminering.
- Kontakt den lokale Medela-representanten for hjelp til produktoperasjoner.
- Ta alltid på hansker ved bruk.

Disse instruksene skal beholdes for senere henvisning.

2 Strømforsyning og batteridrift

Clario Toni er en sugepumpe som drives av strøm fra strømmettet eller fra batterier. Før du kobler apparatet til strømmettet, må du kontrollere at spenningen i det lokale strømmettet er den samme som den som er oppgitt på spesifikasjonsplaten. Ved bruk som beskrevet i denne bruksanvisningen har Clario Toni AC/DC-modellen en maksimal batteritid på 50 minutter før den må lades. Hvis Clario Toni AC/DC-modellen ikke er i bruk, må batteriet kalibreres hver 60.–90. dag.

Lavt batterinivå

Under batteridrift indikerer en langsomt blinkende LED-lampe at det oppladbare batteriet snart er utladet. Clario Toni fortsetter å fungere en kort stund (~10 minutter), men batteriet må lades så snart som mulig.

Utladet batteri

Pumpen stopper når det oppladbare batteriet er utladet. Pumpen fungerer ikke lenger som den skal. Det oppladbare batteriet må lades eller skiftes.

3 Beskrivelse

Innledning

Clario Toni er en sugepumpe av høy kvalitet. Den drives av et velprøvd membransystem. Den kombinerer enkel håndtering og rengjøring med sikkerhetsfunksjoner for å sikre optimal drift. Skal kun brukes i samsvar med instruksjon fra lege, eller etter instruksjon fra annen autorisert medisinsk spesialist.

Tiltenkt bruk

Clario Toni sugepumper er indisert til aspirasjon og fjerning av utsondringer, kroppsvæsker og fremmedlegemer fra luftveiene eller pustestøttesystemet i nese-, svelg- og luftrørsområdene hos pediatriske og voksne pasienter. Denne sugepumpen kan brukes hjemme eller på sykehus, i bil eller utendørs.

Indikasjoner

Clario Toni sugepumpe er indisert for å suge luftveiene enten gjennom nesen, munnen eller en trakeostomikanyle.

Kontraindikasjoner

Instrumentet skal ikke brukes ved langvarig oppsuging.

Tiltenkt bruker

Clario Toni skal bare brukes av personer som har fått egnet opplæring. Disse personene må ikke ha nedsatt hørsel og må ha tilstrekkelig godt syn. Opplæringen må gjenoppriskes minst én gang i året.

Tiltenkt pasientgruppe

Clario Toni er kun ment for bruk på pasienter som har de tilstandene som er beskrevet i indikasjoner for bruk.

Viktig merknad

Det er legens ansvar at hensiktsmessige kirurgiske prosedyrer og teknikker følges. Hver lege må vurdere hvor egnet behandlingen vil være, basert på egen kunnskap og erfaring.

4 Oversikt

Definisjon av vakuum

Ved bruk av medisinsk aspirasjonsutstyr blir vakuum vanligvis angitt som differansen (i absolutte tall) mellom absolutt trykk og atmosfærisk trykk, eller som negative verdier i kilopascal (kPa).

I dette dokumentet vil for eksempel verdien -10 kPa alltid referere til et trykk angitt i kPa under atmosfærisk lufttrykk (i henhold til EN ISO 10079:1999).

Versjoner av pumpen



Clario Toni AC/DC

Pumpens hovedelementer

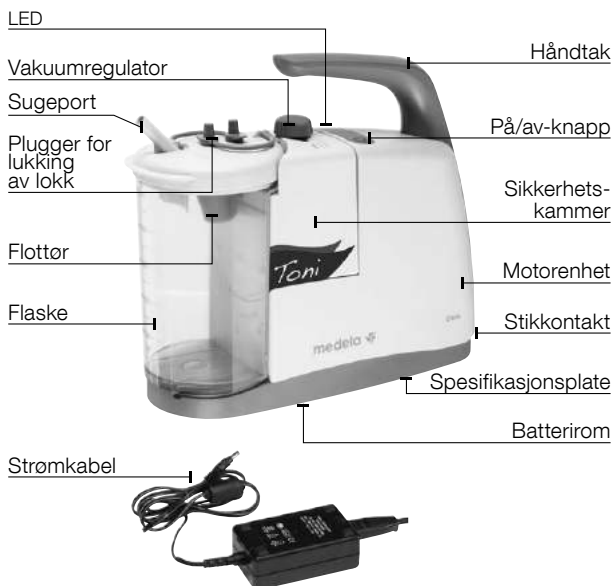

Membranens plassering



Ventilsiver i sikkerhetskammeret

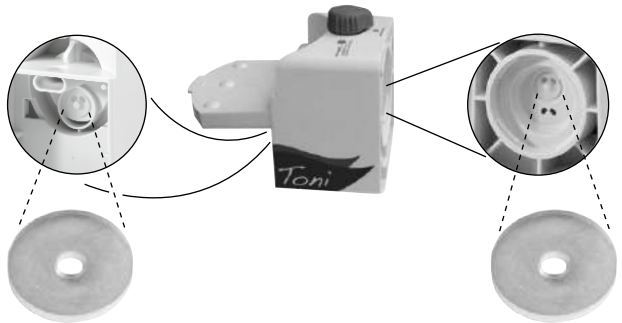

Driftselementer og batteristatus



Vakuumregulator

På/av-knapp

LED-indikator, oppladbart
batteri

ikke tent Batteriet er fullt ladet

- tent**
- Batteriet lades
 - Pumpen er tilkoblet strømnettet

blinker langsomt Batteriet er snart tomt

blinker hurtig Batteriet er defekt

5 Installasjon

Kontroll av leveranse

Kontroller at den leverte pakken med Clario Toni er komplett og i god stand.



Clario Toni-versjoner

REF	Clario Toni AC/DC	014.00XX
	Clario Toni Deluxe	014.00XX



Fingertuppslange for engangsbruk

REF 074.0003



Strømadapter

REF 014.0004

Strømkabel

099.0011 (Euro)

014.0007 (UK)

014.0008 (AUS/NZ)

099.0014 (USA)



Bruksanvisning

REF 200.8400



ADVARSLER

Tilkoblingsslangen som leveres med apparatet, må ikke komme i direkte kontakt med oppsugingsområdet. Et sterilt sugekateter må alltid brukes (infeksjonsrisiko).

6 Klargjøring for bruk



ADVARSLER

Skal bare brukes av medisinsk personell som har fått tilstrekkelig opplæring i oppsugingsprosedyrer og bruk av aspiratorer. Ta alltid på hansker ved bruk.



FORSIKTIG

- Clario Toni skal stå oppreist når den er i bruk.
- Kontroller at emballasjen på sterilt tilbehør er intakt før bruk.
- Ikke-sterilt og flegangs tilbehør skal rengjøres, desinfiseres og/eller steriliseres i henhold til Medelas rengjøringsveiledning (produktkode 200.2391).

6.1 Kontroller før bruk

- Før bruk kontrolleres Clario Toni-systemet for skade på strømkabelen eller støpselet, synlig skade på apparatet eller sikkerhetsfeil, samt at apparatet fungerer som det skal.
- Kontroller at pakken med Clario Toni er komplett og i god stand.
- Sørg for at det oppladbare batteriet kalibreres som beskrevet i kapittel 12.
- Kontroller alt tilbehør før bruk:
 - Flaske og lokk for sprekker, skjørhet og svake punkter. Skift om nødvendig.
 - Slanger for sprekker, skjøre områder og at koblingene sitter som de skal. Skift om nødvendig.

6.2 Montering av flasken

1.





1.1 Monter flottoren på flasken.

2.



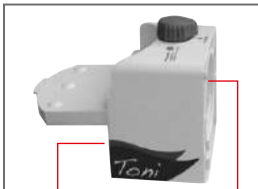
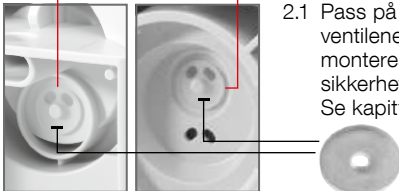

2.1 Fest lokket på flasken. Følg merkingen på forsiden av flasken og lokket.

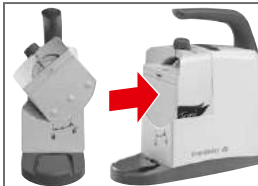
6.3 Montering av sikkerhetskammeret

1.  1.1 Åpne lokket til sikkerhetskammeret.
2.  2.1 Pass på at begge ventilene (silikonskivene) monteres på sikkerhetskammeret. Se kapittel 4.
3.  3.1 Kontroller at lokket til sikkerhetskammeret er godt lukket.
4.  4.1 Hold sikkerhetskammeret og vipp 45° til venstre for å montere det på motorenheten.
4.2 Drei sikkerhetskammeret til loddrett stilling til du hører et klikk.

6.4 Koble flasken til pumpen

1.  1.1 Fest flasken til pumpen. Trykk bestemt.
2.  2.1 Fest fingertuppslangen for engangsbruk til sugeporten.

7 Instruksjoner for bruk



FORSIKTIG

Clario Toni settes opp slik at den enkelt kan kobles fra strømmettet. Kalibrer det oppladbare batteriet før første gangs bruk.



ADVARSLER

Skal bare brukes av medisinsk personell som har fått tilstrekkelig opplæring i oppsugingsprosedyrer og bruk av aspiratorer. Ta alltid på hansker ved bruk.

7.1 Koble Clario Toni til strømmettet

1. Kontroller pumpen før bruk, ifølg instruksjonen i kapittel 6.1.

2. **Alle modeller: Hvis pumpen er koblet til en fast stikkontakt:**

Sett støpselet på strømledningen i en fastmontert stikkontakt.

eller

Hvis pumpen drives via en 12 VDC strømkilde:

Koble den valgfrie 12 VDC-ledningen til pumpen og til 12 VDC-strømkilden.

eller

Hvis pumpen brukes med det oppladbare batteriet:

Tilkobling til strømkilde kreves ikke. Pass på at batteriet er ladet i fem timer.

7.2 Funksjonskontroll med vann

1.

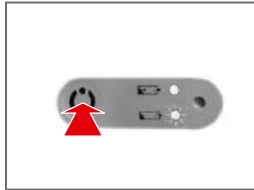

1.1 Trykk på på/av-bryteren for å slå på pumpen.

2.

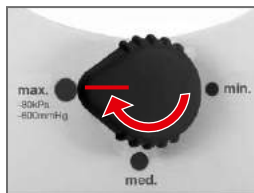

2.1 Sett vakuumregulatoren i stillingen «max.».

3.

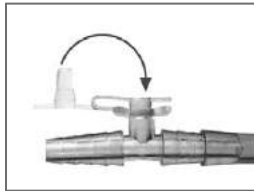

3.1 Fest fingertuppslangen. Se kapittel 6.4, trinn 2.1.
3.2 Plugg igjen fingertuppåpningen.

4.

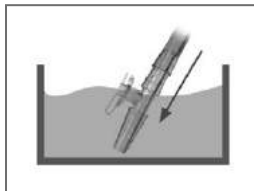

4.1 Stikk slangetuppen i vann og kontroller at det suges.

5. Hvis det er suging, fortsetter du med trinn 6. Hvis ikke, se kapittel 13.

6. Bruk kateter og vakuuminstilling som foreskrevet av en lege.

7.3 Alternativ: funksjonskontroll med vakuummåleren (tilleggsutstyr)



1.1 Fest den valgfrie vakuummåleren til sugeporten.

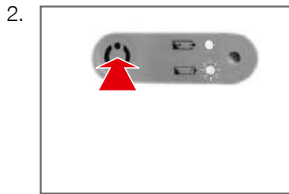

2.1 Trykk på på/av-bryteren for å slå på pumpen.

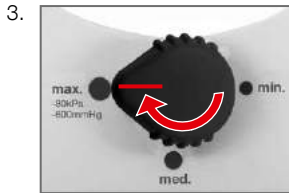

3.1 Sett vakuumregulatoren i stillingen «max.».



4.1 Sammenlign vakuummålingen med verdiene i tabellen til venstre.

Høyde over havet:	Maks. vakuuum:
+ 2000 m	- 63 kPa - 471 mmHg
+ 1000 m	- 71 kPa - 532 mmHg
+ 500 m	- 76 kPa - 566 mmHg
0 m	- 80 kPa - 600 mmHg

(Toleranse: - 15%)

5. Hvis vakuumverdien er i orden, fortsetter du med trinn 6. Hvis ikke, se kapittel 13.

6. Fest fingertuppslangen.

7. Bruk kateter og vakuuminnstillinger som foreskrevet av en lege.



ADVARSLER

Skal bare brukes av medisinsk personell som har fått tilstrekkelig opplæring i oppsugingsprosedyrer og bruk av aspiratorer. Ta alltid på hansker ved bruk.

7.4 Endre vakuumnivå

1.

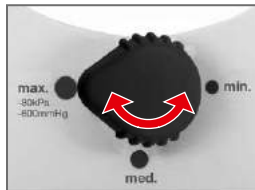

1.1 Still vakuumregulatoren i ønsket stilling.

7.5 Ta ut av drift etter bruk

1.

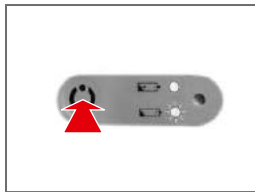

1.1 Trykk på på/av-bryteren for å slå av pumpen.

2. Hvis pumpen er koblet til en fast stikkontakt:

Trekk støpselet ut av stikkontakten.

eller

Hvis pumpen er koblet til en 12 VDC-strømkilde:

Koble 12 VDC-pluggen fra 12 VDC-strømkilden.



3. Rengjør og desinfiser Clario Toni. Se kapittel 16.

8 Tømme flasken



Sikkerhetstips

Flasken tømmes daglig eller senest når væsknivået når 550 ml slik at flottøren stopper innsugingen i flasken.

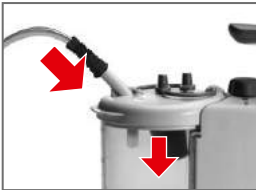
1.  1.1 Trykk på på/av-bryteren for å slå av pumpen.
2.  2.1 Koble fingertuppslangen for engangsbruk fra sugeporten.
2.2 Fjern flasken fra pumpen.
3.  3.1 Flasken må alltid lukkes med pluggene for transport.
4. Tøm flasken og kast fingertuppslangen i henhold til lokale retningslinjer og interne forskrifter.
5.  5.1 Monter en ren flaske.
5.2 Monter en ny fingertuppslange for engangsbruk på sugeporten.
6. Slå på pumpen og still inn vakuumnivået som foreskrevet av legen.

9 Skifte ventilskivene

1.



1.1 Fjern flasken.

2.

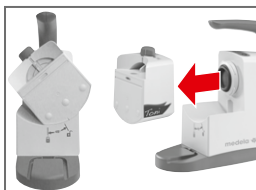

2.1 Drei sikkerhetskammeret 45° til venstre.

2.2 Fjern sikkerhetskammeret ved å trekke det av pumpen.

3.



3.1 Åpne sikkerhetskammeret.

4.

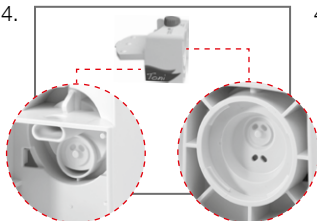

4.1 Skift defekte ventilskiver. Pass på at de nye ventilskivene monteres riktig.

5. Fest sikkerhetskammeret til pumpen som beskrevet i kapittel 6.3.

10 Skifte det oppladbare batteriet



ADVARSLER

Før det oppladbare batteriet skiftes, slår du av Clario Toni og trekker støpselet ut av den fastmonterte stikkontakten.



Trekk støpselet ut av den fastmonterte stikkontakten før dette gjøres.

1.

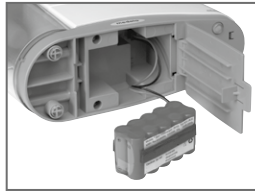

1.1 Åpne lokket til batterirommet på undersiden av Clario Toni.

2.

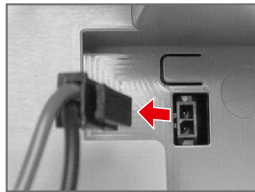

2.1 Koble fra batteriledningen ved å trekke i pluggen.

3. Fjern det gamle oppladbare batteriet.

4. Sett inn det nye oppladbare batteriet.

5.

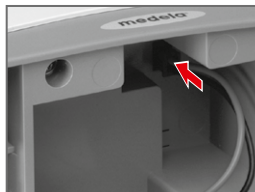

5.1 Monter batteriledningen igjen ved å sette inn pluggen.

6. Lukk lokket til batterirommet. Pass på at lokket lukkes skikkelig, og at batteriledningen ikke kommer i klem.

7. Kalibrer og test det oppladbare batteriet (se kapittel 11/12).

11 Batteridata og -test



FORSIKTIG

Det oppladbare batteriet skal bare lades når ladeindikatoren blinker langsomt.

Pumpetid

Hvis batteriet er helt oppladet, er driftstiden på maks. vakuuum ca. > 50 minutter.

Ladetid (100 % lading)

Ca. 5 timer

Batteristatus

ikke tent

Batteriet er fullt ladet

tent

- Batteriet lades
- Pumpen er tilkoblet strømmettet

blinker langsomt

Batteriet er snart tomt

blinker hurtig

Batteriet er defekt

Teste det

oppladbare batteriet

1. Pass på at det oppladbare batteriet er helt oppladet.
2. Trekk støpselet ut av stikkontakten.

3.

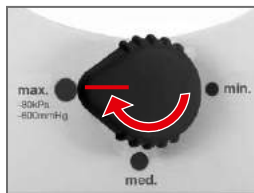

3.1 Sett vakuumregulatoren i stillingen «max.».

4.

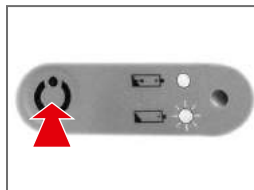

4.1 Slå på Clario Toni. Pumpen begynner å gå.

5. Ta tiden til pumpen stopper. Batteriet er i orden hvis driftstiden er > 50 minutter.

Hvis driftstiden er < 50 minutter, gjentar du testen eller kalibrerer batteriet (se neste side).

12 Kalibrere batteriet



FORSIKTIG

Kalibrer det oppladbare batteriet før første gangs bruk og etter lagring i > 2 måneder. Skift batteriet hvis kalibreringen ikke var tilfredsstillende.

Kalibrere det oppladbare NiMH-batteriet

1. Pass på at det oppladbare batteriet er helt oppladet.

2. Trekk støpselet ut av stikkontakten.

3.

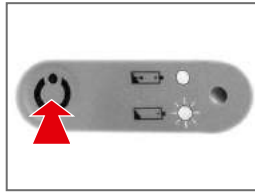

3.1 Slå på Clario Toni.
Pumpen begynner å gå.

4. La pumpen gå til det oppladbare batteriet er utladet og pumpen stopper.

5. Koble Clario Toni til en fast stikkontakt.
Det oppladbare batteriet lades.

6. Vent til ladeindikatoren slukkes.

7. Gjenta trinn 1 til 6. Clario Toni AC/DC er nå klar for bruk.

Oppbevaring av det oppladbare batteriet

For å holde selvutladingen på et minimum bør Clario Toni og de fjernede, oppladbare reservebatteriene oppbevares i temperaturer under 25 °C (77 °F). Gjenta kalibreringsprosessen etter 60–90 dager.

13 Feilsøking

Motoren går ikke

Kontroller følgende:

- Clario Toni er slått på.
- at spenningen i strømforsyningen er riktig, og at støpselet er satt riktig inn i stikkkontakten.
- at det interne batteriet er ladet.

Mye støy fra pumpen

Kontroller ventilskivenes plassering og tetning i sikkerhetskammeret.

Utilstrekkelig vakuüm

Kontroller følgende:

- at vakuümregulatoren er riktig innstilt.
- at slangene ikke er defekte eller ødelagte. Skift om nødvendig.
- at alle pluggtilkoblinger sitter som de skal.
- at innsugingsbeholderen/lokket ikke har sprekker, skjøre områder, misfarging. Skift om nødvendig.
- at ventilskivene i sikkerhetskammeret tetter som de skal.
- at membranen er ren og uten rifter.

Batteriets driftstid er for kort

Kalibrer det oppladbare batteriet. Se kapittel 12.

Ingen LED-lampe tent

Det oppladbare batteriet er helt oppladet.

LED-indikator tent

- Det oppladbare batteriet lades.
- Pumpen er tilkoblet strømmettet.

LED-indikator blinker langsomt

Det oppladbare batteriet er snart utladet. Batteriet har tilstrekkelig strøm til ca. 10 minutters pumping.

LED-indikator blinker raskt

Det oppladbare batteriet er defekt. Se kapittel 10 for utskifting av det defekte batteriet.

14 Garanti og service

Garanti

Medela AG garanterer apparatet mot feil i materialer og utførelse i 2 år fra leveringsdato (6 måneder for det oppladbare batteriet) fra leveringsdato. Defekte materialer erstattes kostnadsfritt i denne perioden, forutsatt at det ikke skyldes misbruk eller feil bruk.

Dette gjelder ikke deler som er utsatt for slitasje under bruk. For å sikre at garantivilkårene oppfylles og at Medela-produktene fungerer optimalt, anbefaler vi utelukkende bruk av tilbehør fra Medela til våre apparater.

Medela AG er ikke under noen omstendighet ansvarlig for krav utenfor garantiomfanget, inkludert indirekte skader osv. Retten til erstatning av defekte deler anerkjennes ikke av Medela hvis det er utført arbeid på pumpen av uautoriserte personer. Denne garantien forutsetter at apparatet returneres til et av Medelas servicesentre.

Service

Service skal bare utføres av personell som er autorisert av Medela. Medela servicehåndbok er tilgjengelig på forespørsel.

15 Kassering

Clario Toni er laget av ulike metaller og plast, og skal kastes i samsvar med EUs direktiver 2011/65/EF og 2012/19/EF. I tillegg skal de lokale forskriftene etterfølges.

For AC/DC-versjoner må de elektroniske komponentene og det oppladbare batteriet kasseres separat, i samsvar med lokale forskrifter.

Sørg for at Clario Toni og tilbehøret kasseres i samsvar med lokale retningslinjer for kassering.



Brukerinformasjon for kassering av elektrisk og elektronisk utstyr

Dette symbolet betyr at elektrisk og elektronisk utstyr ikke skal kastes som vanlig husholdningsavfall. Riktig kassering av dette apparatet beskytter mot og hindrer mulig skade på miljøet eller menneskers helse. Kontakt produsenten, lokale myndigheter eller helseinstitusjon for mer informasjon om kassering. Dette symbolet gjelder bare i EU. Følg gjeldende nasjonale lover og forskrifter i landet der elektrisk og elektronisk utstyr kasseres.

16 Retningslinjer for rengjøring



ADVARSLER

Etter hver gangs bruk skal delene som har vært i kontakt med aspirasjonssekretene rengjøres, desinfiseres, steriliseres eller kastes i henhold til tabellen på neste side.



Trekk støpselet ut av den fastmonterte stikkkontakten før apparatet rengjøres.

Generelle merknader

- Dette er bare generelle anbefalinger, som kan tilpasses individuelt basert på sykehusets spesifikke retningslinjer samt rengjøringsmetoder og prinsipper.
- Detaljert informasjon i samsvar med Medelas rengjøringsinstruksjoner (produktkode 200.2391).
- Bruk vernehansker ved rengjøring/desinfeksjon.
- Kast væsker som blod og sekreter, samt delene som har vært i kontakt med væskene, i henhold til sykehusets forskrifter.

Medela-anbefalte overflatevaskemidler til rengjøring av pumpehuset

- **CaviWipes**, Metrex Research, www.sybrondental.com
- **mikrozyd® AF wipes**, Schülke&Mayr GmbH, www.schuelke.com

Vann

Bruk bare rent vann til rengjøring. Det må tas hensyn til vannets hardhet da avleiringer på medisinske produkter muligens ikke vil bli ordentlig dekontaminert. Bruk avionisert vann for å redusere dette problemet. Det siste skyllevannet skal være bakteriefritt og uten endotoksiner.

Vaske-/desinfeksjonsmaskiner

Kan brukes til å desinfisere deler fra tabellen på neste side. Skylling med varmt vann (maksimal temperatur 100 °C) kan gi middels til høyt nivå av desinfeksjon. Alle deler av de aktuelle delene må være tilgjengelige for å sikre effektiv rengjøring. Vi anbefaler en vaske-/desinfeksjonsmaskin som er godkjent av Robert Koch-instituttet og som samsvarer med ISO 15883. Anbefalt temperatur for ikke-kritiske medisinske apparater (dvs. apparater som bare kommer i kontakt med uskadet hud) er 90 °C i 1 minutt. Varigheten økes til 5 minutter for alle medisinske apparater som regnes som kritiske.



Engangsprodukter

Dette er produkter for engangsbruk som ikke er ment for repressering. Repressering kan medføre tap av mekaniske, kjemiske og/eller biologiske egenskaper. Gjenbruk kan føre til krysskontaminering.

Flaske, sikkerhetskammer	Pumpehus Strømkabel	
x	x	1. Demontering Demonter alle enkeltdele før rengjøring, desinfeksjon og sterilisering.
x		2. Rengjøring av flaske, sikkerhetskammer Rengjør komponentene kun i varmt vann (60–70 °C) med et vaskemiddel med en pH-verdi på mellom 6,0 og 8,0 for å unngå skade på instrumentene og holderne. Enzymholdige vaskemidler kan bidra til å fjerne organisk materiale, for eksempel blod. Vaskemidler skal brukes i henhold til produsentens anbefalte konsentrasjonsnivåer. Enkelte alkaliske rengjøringsmidler har en sammensetning som er trygg for repressering av medisinske apparater. Produsentene av disse rengjøringsmidlene gir informasjon om spesifikke materialer som kan bli skadet av rengjøringsmidlene. Bløtlegg alle deler grundig med varmt såpevann eller i enzymholdig vaskemiddel i 1–5 minutter. 1. Fjern synlig smuss med et rengjøringsredskap – vanlig vaskeborste, piperenser eller kluter uten slipeeffekt. Børster og piperensere skal sitte godt, men det skal være lett å bevege dem rundt i området som skal rengjøres. Skyll grundig i rent vann. La delene tørke 2. Kontroller instrumentene for synlig smuss og gjenta disse trinnene om nødvendig.
	x	3. Rengjøre pumpehuset, strømledningen Tørk av med vaskemiddel som beskrevet over. Tørk med en ren klut.
x		4. Desinfeksjon Bløtlegg i romtemperatur i 30 minutter i en desinfeksjons-/rengjøringsoppløsning (A). Etter reaksjonstiden skylles oppløsningen av delene med rent vann, og slangene skylles. Skyll i minst 2 minutter med rengjøringsoppløsning (B). (A) Flytende aldehyd-fri desinfeksjonsoppløsning med rengjøringseffekt til bruk som bløtleggingsbad, bakteriedrepende middel, soppdrepende middel, begrenset virusdrepende middel, med god materialkompatibilitet for rustfritt stål, ikke-jernholdige materialer og plast inkludert silikon, lett alkalisk, f.eks. 2 % neodisher® Septo MEDsolution. (B) Flytende, pH-nøytral, enzymbasert rengjøringsoppløsning for behandling av instrumenter i maskin eller manuelt med svært god materialkompatibilitet for rustfritt stål, ikke-jernholdige materialer og plast inkludert silikon. eller bruk vaske-/desinfeksjonsmaskin. eller bruk en oppvaskmaskin.
x		5. Oppbevaring av komponentene Etter desinfeksjon lagres komponentene på et rent og tørt håndkle.

17 Tilbehørsoversikt



ADVARSLER

Clario Toni er kontrollert i kombinasjon med tilbehøret i listen nedenfor. Bruk Clario Toni kun med dette tilbehøret for å sikre riktig og sikker funksjon. Ytterligere informasjon finnes på instruksjonsarket for hvert enkelt tilbehør.

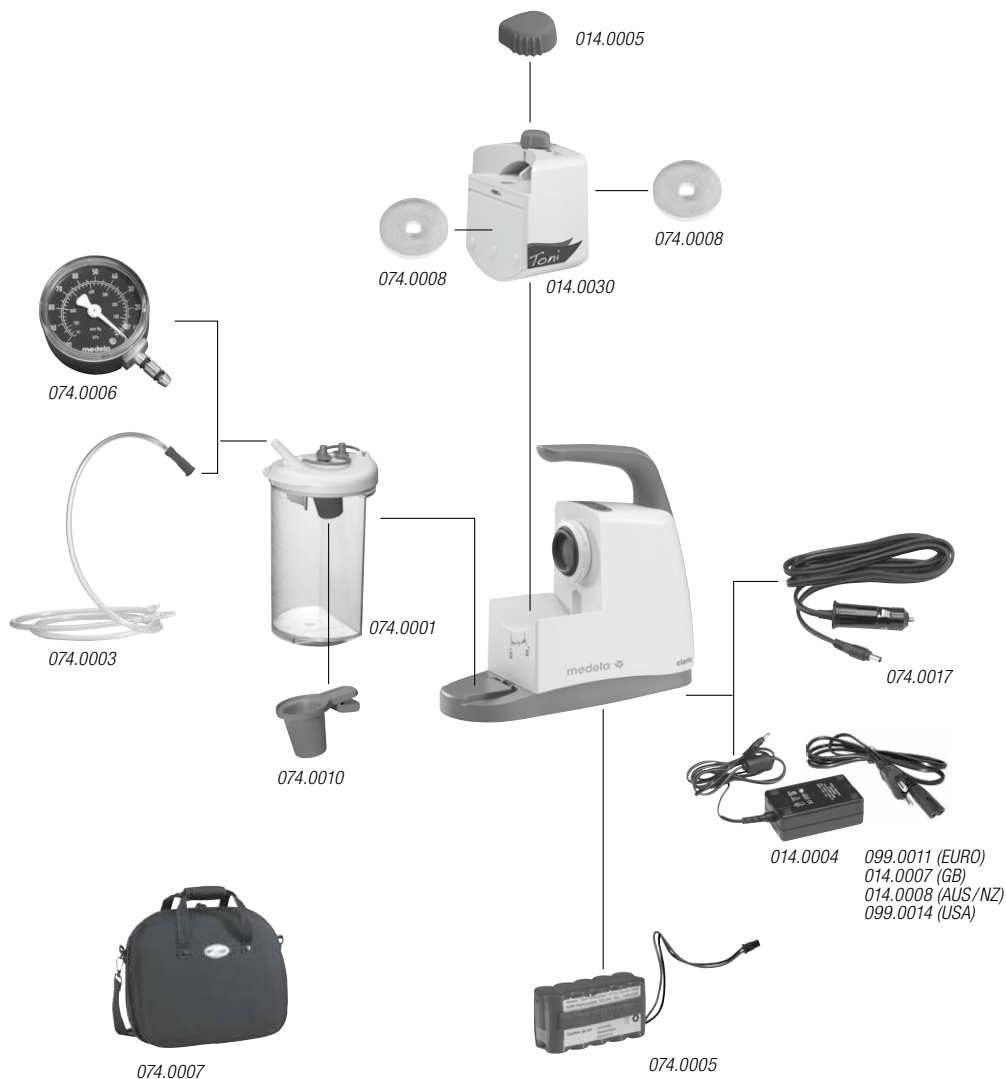

18 Tilbehørsforklaring



Sikkerhetstips

Hvis pumpen brukes sammen med deler fra andre leverandører enn Medela, må de:

- være CE-merket og (om nødvendig) lokalt registrert
- kunne kobles sikkert til Medela-tilbehøret uten at pumpens ytelse påvirkes.

Merk: Ved kombinasjon av Medela-deler og deler fra andre leverandører har du ansvaret for hele systemet.

REF

- 014.0030 Sikkerhetskammer
- 014.0005 Vakuumregulator
- 074.0008 Ventilskiver (10stk.)
- 074.0001 Flaske-sett
- 074.0010 Flottør (10stk.)
- 074.0003 Fingertuppslange for engangsbruk
- 074.0005 Oppladbart batteri
- 014.0004 Strømadapter
- 099.0011 Strømkabel (EURO)
- 099.0014 Strømkabel (USA)
- 014.0007 Strømkabel (GB)
- 074.0007 Bæreveske
- 074.0017 Biltilkoblingsledning for 12 V DC
- 074.0006 Vakuummåler

19 Skilt og symboler



Dette symbolet indikerer samsvar med viktige krav i rådsdirektiv 93/42/EEC av 14. juni 1993 for medisinske apparater.



Dette symbolet indikerer pumpens klasse.



Dette symbolet indikerer at apparatet ikke skal brukes etter angitt måned og år.



Dette symbolet indikerer apparat i klasse II.



Dette symbolet indikerer enhet for engangsbruk. Enheten må ikke gjenbrukes.



Dette symbolet indikerer samsvar med ytterligere sikkerhetskrav for medisinsk elektrisk utstyr i USA og Canada.

IP21

Dette symbolet indikerer beskyttelse mot skadevirkninger som følge av inntrengning av faste fremmedelemerter og vann.

REF

Dette symbolet angir produsentens katalognummer.



Dette symbolet indikerer pumpens juridiske spesifikasjoner.



Dette symbolet indikerer en del av BF-type

SN

Dette symbolet indikerer produsentens serienummer.



Dette symbolet indikerer at bruksanvisningen må følges.



Dette symbolet indikerer MR-USIKKER.

LOT

Dette symbolet indikerer produsentens partikode.



Dette symbolet indikerer at bruksanvisningen må følges.



Dette symbolet indikerer at interferens kan forekomme i nærheten av utstyr merket med dette symbolet.

STERILEEO

Dette symbolet indikerer at apparatet steriliseres med etylenoksid.



Dette symbolet indikerer FORSIKTIG eller ADVARSEL forbundet med apparatet.



Dette symbolet angir produsenten.



Dette symbolet indikerer temperaturbegrensning for drift, transport og lagring.



Dette symboler indikerer sikkerhetsrelaterte tips.



Dette symbolet indikerer produksjonsdato (fire sifre for året og to sifre for måneden).



Dette symbolet indikerer fuktighetsgrenser for drift, transport og lagring.



Dette symbolet indikerer grenser for atmosfæretrykk for drift, transport og lagring.



Dette symbolet indikerer at enheten ikke skal brukes hvis emballasjen er skadet.



Dette symbolet indikerer antall elementer n som innholdet er tilstrekkelig for.



Dette symbolet indikerer at apparatet ikke må kastes som usortert husholdningsavfall (kun for EU).



Dette symbolet indikerer at materialet er en del av en gjenvinnings-/resirkuleringsprosess.



Dette symbolet indikerer kartongemballasje.



Dette symbolet indikerer at apparatet må holdes borte fra sollys.



Dette symbolet indikerer at apparatet må håndteres forsiktig.



Dette symbolet indikerer at apparatet må holdes tørt.



Dette symbolet indikerer pumpens maksimale vakuumnivå.



Dette symbolet indikerer pumpens strømningsnivåer.



Dette symbolet indikerer pumpens elektriske spesifikasjoner.



Dette symbolet indikerer vekselstrøm.



Dette symbolet indikerer likestrøm.



Dette symbolet indikerer pumpens vekt.



Dette symbolet angir pumpens mål (h x b x d).



Dette symbolet indikerer reseptbelagt enhet. **FORSIKTIG:** USA Føderale lover begrenser salg og bruk av dette apparatet til eller etter ordre fra lege. (Kun i USA)



Dette symbolet indikerer antall elementer.

20 Tekniske spesifikasjoner



min. vakuum, - 70 mmHg / - 9 kPa (+/- 20 mmHg / +/- 2.6 kPa)
med. vakuum, - 115 mmHg / - 15 kPa (+/- 30 mmHg / +/- 4 kPa)
maks. vakuum, - 600 mmHg / - 80 kPa (- 90 mmHg / - 12 kPa)

Beregnet ved 0 m, atmosfærisk trykk: 1013 hPa
Merk: Vakuumnivåene kan variere avhengig av plassering (meter over havet, atmosfærisk trykk og temperatur).



lav strømning: 15 l/min. (+/- 10%)



2,0 kg / 4,4 lbs
Uten beholder



100-240 V, 50-60 Hz
12 V, 3,4 A, NiMH
Strømadapter
UE48-120340SPA1



ISO 13485
93/42 EEC Class IIa



h x b x d
223 x 255 x 95 mm



Transport-/oppbevaringsbetingelser



Transport/oppbevaring
Oppladbart batteri

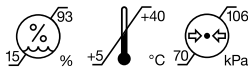

Driftsbetingelser



IP21

21 Teknisk dokumentasjon



ADVARSLER

Bruk ikke annet tilbehør enn det som er spesifisert av eller selges av produsenten ved utskifting av innvendige komponenter. Dette for å unngå økte utslipp eller redusert immunitet for Clario Toni-pumpen.

HF (høyfrekvent) kirurgisk utstyr, radionettverk eller lignende kan påvirke driften av apparatet og må ikke brukes sammen med Clario Toni.

EMK

Clario Toni er EMK-testet i overensstemmelse med kravene i IEC 60601-1-2:2007 og IEC 60601-1-2:2014, 4. utgave i henhold til punkt 7 og 8.9. Clario Toni er et medisinsk apparat som krever spesielle sikkerhetstiltak og som må installeres og settes i drift i samsvar med den vedlagte EMK-informasjonen.

Se også side 326–329.

Índice

Enhorabuena.....	260
1 Advertencias e instrucciones de seguridad	261
Instrucciones de seguridad	263
2 Gestión y funcionamiento de la batería	264
Batería baja.....	264
Batería agotada	264
3 Descripción	265
Introducción.....	265
Aplicaciones / indicaciones.....	265
Contraindicaciones.....	265
Usuario previsto.....	265
Población de pacientes prevista.....	265
Nota importante.....	265
4 Resumen	266
Definición de vacío	266
Versiones del aspirador	266
Componentes principales del aspirador.....	266
Posición de la membrana.....	267
Discos de válvula en la cámara de seguridad	267
Elementos operativos y estado de la batería.....	267
5 Instalación.....	268
Comprobación de la entrega inicial	268
6 Preparación para el uso	269
Comprobaciones previas al uso	269
Montaje del recipiente	269
Montaje de la cámara de seguridad	270
Acoplamiento del recipiente al aspirador	270
7 Instrucciones de uso.....	271
Conexión de Clario Toni a la red eléctrica	271
Control de funcionamiento con agua	272
Alternativa: control de funcionamiento con el manómetro de vacío opcional	273
Cambio del nivel de vacío.....	274
Desconexión tras el uso	274
8 Vaciado del recipiente	275
9 Sustitución de los discos de válvula	276

10	Sustitución de la batería recargable	277
11	Información y prueba de la batería	278
	Duración del aspirado	278
	Tiempo de carga (carga al 100 %).....	278
	Estado de la batería.....	278
	Prueba de la batería recargable	278
12	Calibración de la batería	279
	Calibración de la batería recargable NiMH.....	279
	Almacenamiento de la batería recargable	279
13	Solución de problemas	280
	El motor no funciona	280
	El aspirador hace demasiado ruido.....	280
	El vacío no es suficiente	280
	La duración de la batería es insuficiente	280
	Ningún LED está encendido	280
	LED encendido	280
	El LED parpadea lentamente	280
	El LED parpadea rápidamente	280
14	Garantía y mantenimiento	281
	Garantía.....	281
	Mantenimiento.....	281
15	Eliminación	281
16	Instrucciones de limpieza	282
	Notas generales	282
	Limpiadores de superficies recomendados por Medela para la carcasa del aspirador.....	282
	Agua	282
	Máquinas de limpieza / desinfección	282
	Productos desechables.....	282
17	Resumen de accesorios	284
18	Lista completa de accesorios	285
19	Símbolos	286
20	Especificaciones técnicas	288
21	Documentación técnica	289
	Documentación técnica/EMC	326

Enhorabuena

Al elegir Clario Toni, se ha decantado por un aspirador de alta calidad que se adapta a sus necesidades y solo puede ser prescrito por un profesional sanitario / médico. Este producto proporciona un diseño higiénico triple único y una protección antidesbordamiento óptima. Funciona mediante un sistema de membrana con un motor eléctrico. La fuerza de succión puede ajustarse al nivel deseado utilizando los 3 ajustes de vacío. Como todos los dispositivos de Medela, ofrece una succión sencilla y fiable. Además dispone de ventajas adicionales: fácil manejo, limpieza sencilla y funciones de seguridad. Póngase en contacto con nosotros, será un placer asesorarle.

1 Advertencias e instrucciones de seguridad



ADVERTENCIA

Indica una situación potencialmente peligrosa que, de no evitarse, puede provocar lesiones graves o incluso la muerte.



PRECAUCIÓN

Indica una situación potencialmente peligrosa que, de no evitarse, puede provocar lesiones leves o moderadas.



Consejo de seguridad

Ofrece información útil sobre el uso seguro del dispositivo.

Clario Toni solo está aprobado para el uso descrito en estas instrucciones. Medela solo puede garantizar el funcionamiento seguro del sistema si Clario Toni se utiliza en combinación con los accesorios de Medela originales. Consulte los capítulos 17 y 18.

Lea y cumpla estas advertencias e instrucciones de seguridad antes de usar el dispositivo. Estas instrucciones de uso deben conservarse con el aspirador para su uso en el futuro.

Este manual sirve como guía general para la utilización del producto. Las cuestiones médicas deben ser resueltas por un profesional.

Medela solo se responsabiliza de los efectos en la SEGURIDAD BÁSICA, fiabilidad y rendimiento de Clario Toni si se utiliza de acuerdo con las instrucciones de uso.

PRECAUCIÓN: de acuerdo con la legislación federal de Estados Unidos, la venta de este dispositivo solo podrá realizarla un médico u otra persona a petición de un médico.

Sujeto a modificaciones.



ADVERTENCIA

- Solo deben usarlo personas formadas en el ámbito médico con los conocimientos adecuados en procedimientos de succión y en el uso de aspiradores.
- Siempre debe estar disponible un aparato de repuesto para aquellos pacientes a los que una avería del aparato les pueda implicar una situación crítica (por ejemplo, pacientes con disnea aguda o una congestión catarral grave).
- El dispositivo no debe usarse para succionar líquidos explosivos, corrosivos o fácilmente inflamables.
- El tubo de conexión suministrado con el dispositivo nunca debe entrar en contacto directo con el área de succión. Utilice siempre un tubo de aspiración estéril para evitar el riesgo de infección.
- Antes de limpiar el dispositivo, saque el enchufe de la toma de corriente.
- No está permitido realizar modificaciones en el equipo.
- No debe conectar este dispositivo a un tubo de drenaje pasivo.
- Antes de utilizar Clario Toni, lea atentamente las instrucciones de uso y tenga en cuenta los factores de riesgo y las contraindicaciones. En caso contrario, se podrían producir lesiones graves o mortales en el paciente.
- No utilice Clario Toni en un entorno de IRM (Imágenes de Resonancia Magnética).
- La fuente de alimentación podría sufrir daños en caso de que se produzca una descarga electrostática (ESD) en el puerto de CC de 15 kV.



PRECAUCIÓN

- El uso incorrecto puede provocar lesiones y dolor en el paciente.
- No utilice los accesorios estériles si su envase presenta daños.
- El uso de equipos de comunicación inalámbrica, como dispositivos domésticos de red inalámbrica, teléfonos móviles, teléfonos inalámbricos y sus soportes, o walkie-talkies, puede afectar al Clario Toni, por lo que este se debe mantener a una distancia mínima de 30 cm (1 ft) de los equipos.
- Los equipos de comunicaciones RF móviles y portátiles pueden afectar a los productos sanitarios.



Consejo de seguridad

- Para las pruebas de seguridad, se entiende que durante su vida útil se prestará mantenimiento y reparación al dispositivo de acuerdo con las instrucciones de servicio. Clario Toni es un dispositivo de clase de protección II (EN CEI 60601-1, A1, A2:1995) y por esta razón las pruebas de seguridad se limitan a la inspección visual de la carcasa y el cable de alimentación. Esta prueba se debe llevar a cabo antes de cada uso.
- Comprobación de la corriente de fuga del paciente: consulte el manual de servicio.
- La protección de Clario Toni frente a los efectos de la descarga de un desfibrilador depende del uso de los cables adecuados.
- La separación de la red solo puede asegurarse desconectando el dispositivo del enchufe y la toma de corriente.
- Antes de enchufar el dispositivo, compruebe que la tensión del suministro eléctrico local sea la misma que la descrita en la placa de características.

Instrucciones de seguridad

- Clario Toni de Medela es un dispositivo médico que requiere medidas de seguridad especiales en lo que se refiere a CEM. Se debe instalar y poner en funcionamiento de acuerdo con la información CEM adjunta.
- En cada uno de los casos siguientes el dispositivo no debe usarse y lo deben reparar los servicios de atención al cliente:
 - si el cable o el enchufe están dañados
 - si el dispositivo no funciona a la perfección
 - si el dispositivo está dañado
 - si el dispositivo muestra claros defectos de seguridad.
- Aleje el cable de alimentación de superficies calientes.
- El enchufe y el botón ON / OFF no deben estar en contacto con humedad.
- No desenchufe nunca el dispositivo de la toma de corriente tirando del cable de conexión.
- No deje nunca el dispositivo sin vigilar mientras está encendido.
- Durante su uso, el aspirador debe permanecer en posición vertical.
- No se coloque nunca el cable de alimentación alrededor del cuello.
- No utilice el dispositivo cuando la temperatura ambiente sea muy alta, en el baño o la ducha, si está muy cansado o en un entorno con riesgo de explosión.
- No introduzca nunca el dispositivo en agua u otros líquidos.
- Cuando utilice productos estériles de un solo uso, tenga en cuenta que no deberían ser reprocessados: podrían perder características mecánicas, químicas y / o biológicas. La reutilización podría provocar contaminación cruzada.
- Si desea obtener ayuda con el manejo de los productos, póngase en contacto con el representante local de Medela.
- Utilice los guantes para todas las aplicaciones.

Estas instrucciones de uso se deben guardar a modo de referencia.

2 Gestión y funcionamiento de la batería

Clario Toni es un aspirador que funciona conectado a la red eléctrica y por batería. Antes de enchufar el dispositivo, compruebe que la tensión del suministro eléctrico local sea la misma que la descrita en la placa de características. Si el modelo CA / CC de Clario Toni se utiliza como se indica en este manual de instrucciones, la batería tiene una duración máxima de 50 minutos antes de tener que volver a cargarla. En caso de no utilizar el modelo CA / CC de Clario Toni, deberá calibrar la batería cada 60–90 días.

Batería baja

Durante el funcionamiento por batería, si el indicador LED parpadea lentamente indica que la batería recargable está agotando su carga. Clario Toni seguirá funcionando por un corto periodo de tiempo (aprox. 10 minutos), pero la batería debe recargarse lo antes posible.

Batería agotada

Cuando la batería recargable se agota, el aspirador detiene su funcionamiento. No puede mantenerse un funcionamiento correcto del aspirador. Debe recargarse o sustituirse la batería recargable.

3 Descripción

Introducción

Clario Toni es un aspirador de alta calidad. Funciona mediante un sistema de membrana de eficacia probada. Combina de manera ideal un manejo y limpieza sencillos con funciones de seguridad para garantizar un funcionamiento óptimo. Solo debe utilizarse siguiendo las indicaciones de su médico y tras haber recibido instrucciones de especialistas médicos.

Uso previsto

Los aspiradores de secreciones Clario Toni están indicados para aspirar y eliminar secreciones, fluidos corporales y cuerpos extraños de las vías respiratorias o de un sistema de respiración asistida en las áreas nasal, faríngea y traqueal de pacientes adultos o pediátricos. Este aspirador es adecuado para su uso en el hogar, hospitales, en vehículos o en el exterior.

Indicaciones

El aspirador de secreciones Clario Toni está indicado para despejar las vías respiratorias ya sea a través de la nariz, de la boca o de un tubo de traqueotomía.

Contraindicaciones

Este dispositivo no debe utilizarse para una succión prolongada.

Usuario previsto

Clario Toni solo debe ser utilizado por usuarios con la formación adecuada. Estos especialistas no pueden tener problemas auditivos o ser sordos y deben tener unas facultades visuales adecuadas. La formación debe actualizarse al menos una vez al año.

Población de pacientes prevista

Clario Toni se ha pensado únicamente para su uso en pacientes que muestran aquellas afecciones descritas en las indicaciones de uso.

Nota importante

El cumplimiento de las técnicas y procedimientos quirúrgicos adecuados es responsabilidad del médico. Cada médico debe evaluar la idoneidad del tratamiento según sus propios conocimientos y experiencia.

4 Resumen

Definición de vacío

En la aplicación de dispositivos médicos de aspiración, el vacío normalmente se da como diferencia (en valores absolutos) entre la presión absoluta y la presión atmosférica o como valores negativos en kilopascales (kPa). En este documento, la indicación de -10 kPa, por ejemplo, siempre se refiere a un intervalo de presión en kPa por debajo de la presión atmosférica ambiental (de acuerdo con la norma EN ISO 10079:1999).

Versiones del aspirador



Clario Toni CA / CC

Componentes principales del aspirador



Posición de la membrana



Discos de válvula en la cámara de seguridad

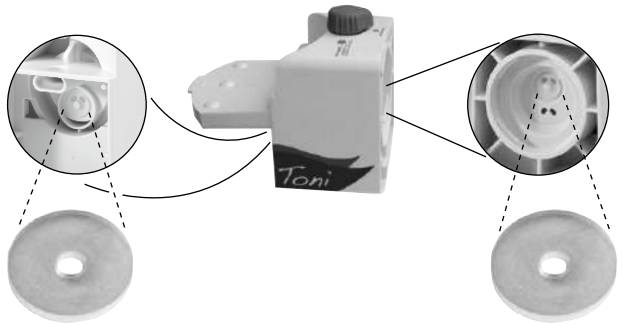

Elementos operativos y estado de la batería

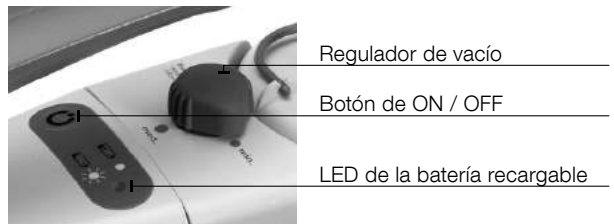

- apagado** Batería cargada
- encendido**
 - La batería se recarga
 - El aspirador está enchufado
- parpadea lentamente** La batería está a punto de agotarse
- parpadea rápidamente** La batería es defectuosa

5 Instalación

Comprobación de la entrega inicial

Revise el embalaje de Clario Toni para comprobar que está completo y en buenas condiciones.



Versiones de Clario Toni

REF	Clario Toni CA / CC	014.00XX
	Clario Toni Deluxe	014.00XX



Tubo de aspiración desechable

REF 074.0003



Transformador

REF 014.0004

Cable de alimentación

099.0011 (Euro)

014.0007 (UK)

014.0008 (AUS / NZ)

099.0014 (USA)



Instrucciones de uso

REF 200.8400



ADVERTENCIAS

El tubo de conexión suministrado con el dispositivo nunca debe entrar en contacto directo con el área de succión. Debe usarse siempre un catéter de succión estéril (riesgo de infección).

6 Preparación para el uso



ADVERTENCIA

Solo deben usarlo personas formadas en el ámbito médico con los conocimientos adecuados en procedimientos de succión y en el uso de aspiradores. Utilice los guantes para todas las aplicaciones.



PRECAUCIÓN

- Durante el uso, Clario Toni debe permanecer en posición vertical.
- Compruebe que el envase de los accesorios estériles no presenta daños antes de su uso.
- Los accesorios no estériles o reutilizables se deben limpiar, desinfectar y / o esterilizar de acuerdo con la guía de limpieza de Medela (código de producto 200.2391).

6.1 Comprobaciones previas al uso

- **Revise el sistema Clario Toni antes de su uso para comprobar que funciona correctamente y que no hay daños en el cable de conexión, enchufe y dispositivo o defectos de seguridad.**
- **Compruebe que el embalaje en el que se ha enviado Clario Toni se encuentra completo y en buenas condiciones.**
- **Asegúrese de que la batería recargable se ha calibrado siguiendo las instrucciones del capítulo 12.**
- **Compruebe todos los accesorios antes de su uso:**
 - **Vigile que no haya roturas, zonas quebradizas o defectos en el recipiente y la tapa. Sustitúyalos en caso necesario.**
 - **En los tubos, observe que no haya daños o defectos y que las conexiones se encuentren bien acopladas. Sustitúyalos en caso necesario.**

6.2 Montaje del recipiente

1.



1.1 Acople el flotador al recipiente.

2.



2.1 Coloque la tapa en el recipiente. Preste atención a las marcas de la parte frontal del recipiente y la tapa.

6.3 Montaje de la cámara de seguridad

1.

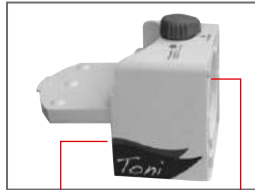

1.1 Abra la tapa de la cámara de seguridad.

2.

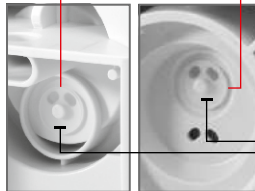

2.1 Asegúrese de que ambas válvulas (discos de silicona) están acopladas a la cámara de seguridad. Consulte el capítulo 4.

3.



3.1 Asegúrese de que la tapa de la cámara de seguridad está bien cerrada.

4.

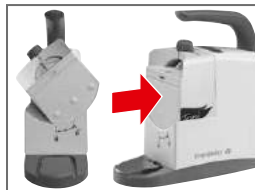

4.1 Incline la cámara de seguridad 45° a la izquierda para acoplarla a la unidad del motor.

4.2 Gire la cámara de seguridad a una posición vertical hasta oír un clic.

6.4 Acoplamiento del recipiente al aspirador

1.



1.1 Acople el recipiente al aspirador. Presione con firmeza.

2.



2.1 Acople el tubo de aspiración desechable al puerto de succión.

7 Instrucciones de uso



PRECAUCIÓN

Configure Clario Toni de tal forma que se pueda separar del suministro eléctrico de forma sencilla. Calibre la batería recargable antes del primer uso.



ADVERTENCIA

Solo deben usarlo personas formadas en el ámbito médico con los conocimientos adecuados en procedimientos de succión y en el uso de aspiradores. Utilice los guantes para todas las aplicaciones.

7.1 Conexión de Clario Toni a la red eléctrica

1. Revise el aspirador antes de su uso según las instrucciones del capítulo 6.1.

2. **Todos los modelos: si el aspirador está conectado a una toma de corriente:**

Enchufe el cable de alimentación a la toma de corriente.

o

Si la bomba funciona con una fuente de alimentación de 12 V CC:

Conecte el cable de conexión opcional de 12 V CC al aspirador y a la fuente de alimentación de 12 V CC.

o

Si el aspirador funciona mediante una batería recargable:

No es necesario conectar a ninguna fuente de alimentación. Asegúrese de que la batería se ha cargado durante cinco horas.

7.2 Control de funcionamiento con agua

1.

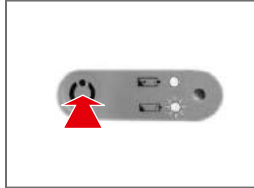

1.1 Pulse el botón de ON / OFF para encender el aspirador.

2.

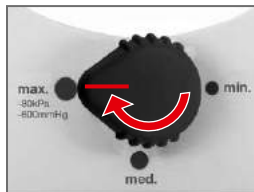

2.1 Sitúe el regulador de vacío en la posición "máx.".

3.

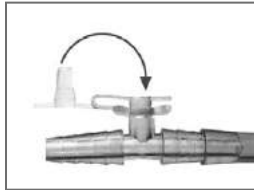

3.1 Acople el tubo de aspiración. Consulte el paso 2.1 en el capítulo 6.4.

3.2 Acople el puerto del tubo de aspiración.

4.

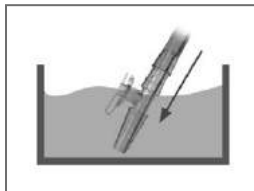

4.1 Coloque el tubo de aspiración en el agua y compruebe que succiona.

5. Si succiona, vaya al paso 6. En caso contrario, consulte el capítulo 13.

6. Utilice el tubo y el ajuste de vacío prescrito por el médico.

7.3 Alternativa: control de funcionamiento con el manómetro de vacío opcional



1.1 Acople el manómetro de vacío opcional al puerto de succión.

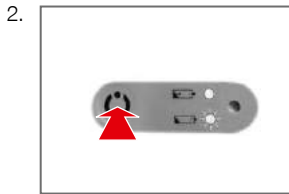

2.1 Pulse el botón de ON / OFF para encender el aspirador.

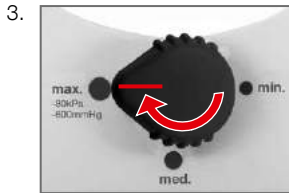

3.1 Sitúe el regulador de vacío en la posición "máx.".

Altitud sobre el nivel del mar: Vacío máx.:

+ 2000 m	- 63 kPa - 471 mmHg
+ 1000 m	- 71 kPa - 532 mmHg
+ 500 m	- 76 kPa - 566 mmHg
0 m	- 80 kPa - 600 mmHg

(Tolerancia: -15 %)



4.1 Compare el vacío con los valores indicados en la tabla de la izquierda.

5. Si el vacío es correcto, vaya al paso 6. En caso contrario, consulte el capítulo 13.

6. Acople el tubo de aspiración.

7. Utilice el tubo y el ajuste de vacío prescritos por su médico.



ADVERTENCIA

Solo deben usarlo personas formadas en el ámbito médico con los conocimientos adecuados en procedimientos de succión y en el uso de aspiradores. Utilice los guantes para todas las aplicaciones.

7.4 Cambio del nivel de vacío

1.

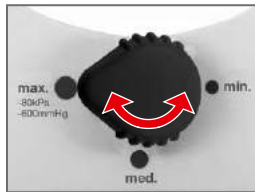

1.1 Coloque el regulador de vacío en la posición necesaria.

7.5 Desconexión tras el uso

1.

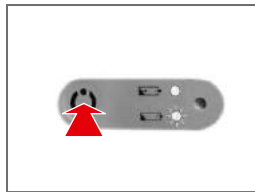

1.1 Pulse el botón ON / OFF para apagar el aspirador.

2. Si el aspirador está conectado a una toma de corriente:

Desconecte el enchufe de la toma de corriente.

o

Si el aspirador está conectado a una fuente de alimentación de 12 V CC:

Desconecte el enchufe de 12 V CC de la fuente de alimentación de 12 V CC.





3. Limpie y desinfecte Clario Toni. Consulte el capítulo 16.

8 Vaciado del recipiente

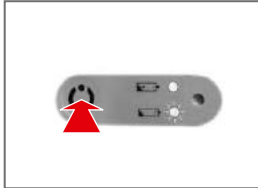

Consejo de seguridad

El recipiente debe vaciarse a diario o como máximo cuando el nivel de líquido alcance los 550 ml y el flotador detenga la succión hacia el recipiente.

-  1.1 Pulse el botón ON / OFF para apagar el aspirador.
-  2.1 Desconecte el tubo de aspiración desechable del puerto de succión.
2.2 Retire el recipiente del aspirador.
-  3.1 Para su transporte, cierre siempre el recipiente con los tapones.
4. Vacíe el recipiente y elimine el tubo de aspiración en función de las normativas locales y del centro.
-  5.1 Acople un recipiente limpio.
5.2 Acople un nuevo tubo de aspiración desechable al puerto de succión.
6. Encienda el aspirador y ajuste el vacío al modo prescrito por su médico.

9 Sustitución de los discos de válvula

- 1.  1.1 Retire el recipiente.

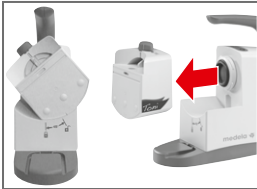
- 2.  2.1 Gire la cámara de seguridad 45° a la izquierda.
2.2 Retire la cámara de seguridad tirando de ella.

- 3.  3.1 Abra la cámara de seguridad.

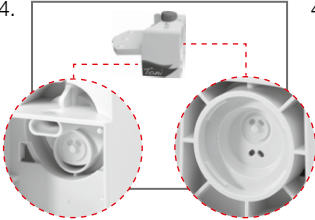
- 4.  4.1 Sustituya los discos de válvula defectuosos. Asegúrese de que los nuevos discos de válvula están bien acoplados.

- 5. Acople la cámara de seguridad al aspirador como se describe en el capítulo 6.3.

10 Sustitución de la batería recargable



ADVERTENCIA

Antes de sustituir la batería recargable, apague Clario Toni y saque el enchufe de Clario Toni de la toma de corriente.



Antes de sustituir la batería, saque el enchufe de la toma de corriente.

1.

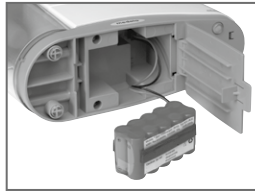

1.1 Abra la tapa del compartimento de la batería situado en la parte inferior de Clario Toni.

2.

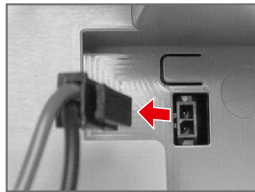

2.1 Desconecte el cable de la batería tirando del enchufe.

3. Retire la batería recargable antigua.

4. Introduzca la nueva batería recargable.

5.

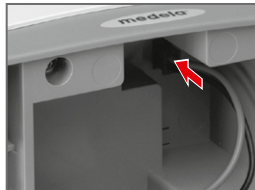

5.1 Vuelva a acoplar el cable de la batería conectando el enchufe.

6. Cierre la tapa del compartimento de la batería. Asegúrese de que la tapa está bien cerrada y que el cable de la batería no queda pinzado ni comprimido.

7. Calibre y pruebe la batería recargable (consulte los capítulos 11 y 12)

11 Información y prueba de la batería



PRECAUCIÓN

Solo debe cargar la batería recargable cuando el indicador de carga parpadee lentamente.

Duración del aspirado

Si la batería está completamente cargada, el tiempo de funcionamiento con el vacío máximo es de aproximadamente >50 minutos.

Tiempo de carga (carga al 100 %)

Aprox. 5 horas

Estado de la batería

apagado

Batería cargada

encendido

- La batería se recarga
- El aspirador está enchufado

parpadea lentamente

La batería está a punto de agotarse

parpadea rápidamente

La batería es defectuosa

Prueba de la batería recargable

1. Asegúrese de que la batería recargable está completamente cargada.
2. Saque el enchufe de la toma de corriente.

3.

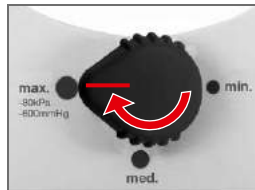

3.1 Sitúe el regulador de vacío en la posición "máx.".

4.

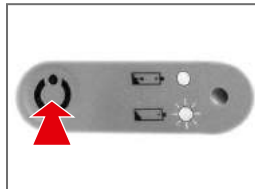

4.1 Encienda Clario Toni. El aspirador empieza a funcionar.

5. Mida el tiempo transcurrido hasta que el aspirador se detenga. La batería está bien si el tiempo de funcionamiento es superior a 50 minutos.

Si el tiempo de funcionamiento es inferior a 50 minutos, repita la prueba o vuelva a calibrar la batería (consulte la siguiente página).

12 Calibración de la batería



PRECAUCIÓN

Calibre la batería recargable antes del primer uso y si ha estado almacenada durante más de dos meses. Sustituya la batería si la calibración no resuelve el problema.

Calibración de la batería recargable NiMH

1. Asegúrese de que la batería recargable está completamente cargada.
2. Saque el enchufe de la toma de corriente.

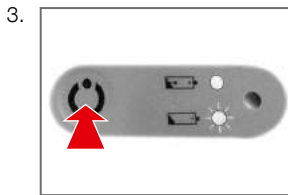

3.1 Encienda Clario Toni. El aspirador empieza a funcionar.

4. Deje que el aspirador funcione hasta que la batería recargable se descargue y el aspirador se detenga.
5. Conecte Clario Toni a una toma de corriente. La batería recargable se recarga.
6. Espere a que el indicador de carga se apague.
7. Repita los pasos del 1 al 6. Clario Toni CA / CC está listo para funcionar.

Almacenamiento de la batería recargable

Para mantener al mínimo la autodescarga, almacene el dispositivo Clario Toni y sus baterías recargables de sustitución, previamente extraídas, a una temperatura inferior a 25 °C (77 °F). Repita el proceso de calibración cada 60–90 días.

13 Solución de problemas

El motor no funciona

Compruebe que:

- Clario Toni está encendido.
- la tensión de suministro es la correcta y el enchufe está bien introducido en la toma de corriente.
- la batería interna está cargada.

El aspirador hace demasiado ruido

Compruebe la posición y la junta de los discos de válvula en la cámara de seguridad.

El vacío no es suficiente

Compruebe que:

- el regulador de vacío está bien configurado.
- los tubos no muestran defectos ni roturas. Sustitúyalos en caso necesario.
- todas las conexiones están bien realizadas.
- el recipiente / la tapa de aspiración no muestran fisuras, áreas quebradizas ni decoloración. Sustitúyalos en caso necesario.
- la junta de los discos de válvula dentro de la cámara de seguridad es hermética.
- la membrana está limpia y no tiene rasguños.

La duración de la batería es insuficiente

Calibre la batería recargable. Consulte el capítulo 12.

Ningún LED está encendido

La batería recargable está completamente cargada.

LED encendido

- La batería recargable se recarga.
- El aspirador está enchufado.

El LED parpadea lentamente

La batería recargable está a punto de agotarse. La batería dispone de suficiente energía para unos 10 minutos de aspiración.

El LED parpadea rápidamente

La batería recargable es defectuosa. Para sustituir una batería defectuosa, consulte el capítulo 10.

14 Garantía y mantenimiento

Garantía

Medela AG garantiza que el dispositivo no sufrirá defectos en los materiales y la fabricación durante un periodo de 2 años (6 meses para la batería recargable) desde la fecha de envío. Los materiales defectuosos serán reemplazados sin coste alguno durante este tiempo siempre y cuando no se deba a abusos o usos indebidos. Esto no se aplicará a las piezas expuestas al desgaste durante su uso. Para asegurar el cumplimiento de esta garantía, así como un servicio óptimo de nuestros productos, recomendamos que utilice únicamente accesorios de Medela con nuestros dispositivos.

Medela AG rechaza toda responsabilidad fuera del ámbito de la garantía descrita, incluida la responsabilidad por daños consecuentes. Medela no se hará cargo del derecho a la sustitución de piezas defectuosas cuando el aspirador haya sido manipulado por personas no autorizadas. La presente garantía está sujeta a la devolución del dispositivo a un centro de mantenimiento de Medela.

Mantenimiento

Los trabajos de mantenimiento solo deben realizarlos empleados autorizados por Medela. El manual de servicio de Medela se encuentra disponible previa petición.

15 Eliminación

Clario Toni incluye metales y plásticos y debe desecharse de conformidad con las directivas europeas 2011/65/CE y 2012/19/CE. Asimismo, también deben tenerse en cuenta las normativas locales. Para las versiones CA / CC, los componentes electrónicos y la batería recargable deben eliminarse de forma independiente, según la normativa local. Deseche Clario Toni y sus accesorios de acuerdo con las normativas locales.



Información para el usuario sobre la gestión de residuos de equipos eléctricos y electrónicos

Este símbolo indica que los equipos eléctricos y electrónicos no se pueden desechar como cualquier otro residuo doméstico común. La eliminación correcta de este dispositivo protege al medio ambiente y evita posibles daños a este o a la salud. Para obtener más información sobre la eliminación de estos residuos, póngase en contacto con el fabricante o con su profesional sanitario o cuidador local. Este símbolo es válido únicamente dentro de la Unión Europea. Respete la normativa y legislación de su país en materia de gestión de residuos de equipos eléctricos y electrónicos.

16 Instrucciones de limpieza



ADVERTENCIA

Después de cada uso, las partes que hayan estado en contacto con las secreciones aspiradas deben limpiarse, desinfectarse, esterilizarse o desecharse de **acuerdo con la información recogida en la tabla de la página siguiente.**

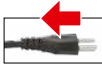

Antes de limpiar el dispositivo, saque el enchufe de la toma de corriente.

Notas generales

- Aquí se apuntan recomendaciones generales que se pueden personalizar, en función de las prácticas y políticas de limpieza, así como las directivas específicas del hospital.
- Información detallada de conformidad con las instrucciones de limpieza de Medela (código de producto 200.2391).
- Para la limpieza / desinfección debe llevar guantes de protección.
- Elimine los líquidos como sangre y secreciones y las piezas contaminadas con estos de acuerdo con las directrices internas del hospital.

Limpiadores de superficies recomendados por Medela para la carcasa del aspirador

- **CaviWipes**, Metrex Research, www.sybrondental.com
- **mikrozid® AF wipes**, Schülke&Mayr GmbH, www.schuelke.com

Agua

Utilice solo el agua de mayor pureza para limpiar. La dureza del agua es una característica que se debe tener muy en cuenta: los depósitos que quedan en los productos sanitarios pueden no estar adecuadamente descontaminados. Utilice agua desionizada para reducir este problema. El agua de aclarado final no debe contener bacterias ni endotoxinas.

Máquinas de limpieza / desinfección

Se pueden utilizar para desinfectar los componentes recogidos en la tabla de la página siguiente. Un aclarado con agua caliente (temperatura máxima de 100 °C) puede proporcionar un nivel de desinfección medio-alto. Se debe poder acceder a todas las piezas constituyentes para asegurar una limpieza eficiente. Recomendamos el uso de una máquina de limpieza / desinfección aprobada por el Instituto Robert Koch y que cumpla con la norma ISO 15883. La temperatura recomendada para los productos sanitarios no críticos (es decir, aquellos que solo están en contacto con piel sana) es de 90 °C durante 1 minuto. Este tiempo aumenta a 5 minutos en todos los dispositivos médicos considerados críticos.



Productos desechables

Este tipo de producto está pensado para un solo uso y no debe ser reprocesado, ya que podrían perderse características mecánicas, químicas y / o biológicas. La reutilización podría provocar contaminación cruzada.

Recipiente, cámara de seguridad	Carcasa del aspirador Cable de red	
X	X	<p>1. Desmontaje Separe todos los componentes individuales antes de limpiar, desinfectar y esterilizar.</p>
X		<p>2. Limpieza del recipiente y cámara de seguridad Limpie los componentes en agua caliente (60–70 °C) con un detergente de pH entre 6.0 y 8.0 para evitar dañar los instrumentos y dispositivos contenedores. Los detergentes enzimáticos ayudan a eliminar materia orgánica, como la sangre. Los detergentes se deben utilizar en función de los niveles de concentración recomendados por el fabricante. Algunos detergentes alcalinos se han formulado de tal forma que sean seguros para el reprocesamiento de productos sanitarios. Los fabricantes de estos detergentes deben proporcionar información sobre los materiales específicos que pueden sufrir daños a causa de su uso. Sumerja todos los componentes en agua caliente y jabonosa o en detergente enzimático y déjelos en remojo entre 1 y 5 minutos.</p> <p>1. Elimine la suciedad visible con una herramienta de limpieza o cepillos de limpieza multiusos, como por ejemplo un limpiapipas o un paño no abrasivo sin pelusas. Utilice cepillos o limpiapipas que se ajusten al espacio pero que también pueda mover con facilidad dentro del área de limpieza. Aclare con abundante agua limpia. Deje secar.</p> <p>2. Compruebe que no haya suciedad visible en los instrumentos y repita estos pasos en caso necesario.</p>
	X	<p>3. Limpieza de la carcasa del aspirador y el cable de red Limpie con el detergente mencionado anteriormente. Utilice un paño limpio para secar.</p>
X		<p>4. Desinfección Sumérjalo a temperatura ambiente durante 30 minutos en una solución de limpieza / desinfección (A). Tras el tiempo de reacción, utilice agua para aclarar los residuos de solución de los componentes individuales y aclare el tubo. Utilice la solución de limpieza (B) para un aclarado de al menos 2 minutos.</p> <p>(A) Solución de desinfección líquida sin aldehídos con un efecto de limpieza para su uso a remojo, como bactericida, fungicida o viricida limitado. Con una buena compatibilidad material con el acero inoxidable, los materiales no ferrosos y los plásticos, silicona incluida. Ligeramente alcalino. Por ejemplo, neodisher® Septo MEDsolution 2 %.</p> <p>(B) Solución de limpieza enzimática líquida con pH neutro para el tratamiento de instrumentos a máquina o de forma manual. Muy buena compatibilidad material con el acero inoxidable, los materiales no ferrosos y los plásticos, silicona incluida.</p> <p>o utilice una máquina de limpieza / desinfección. o utilice un lavavajillas.</p>
X		<p>5. Almacenamiento de los componentes Después de desinfectar, almacene los componentes en un paño limpio y seco.</p>

17 Resumen de accesorios



ADVERTENCIA

Se ha comprobado el funcionamiento de Clario Toni junto con los accesorios recogidos a continuación. Para un funcionamiento correcto y seguro, utilice Clario Toni únicamente con estos accesorios. Consulte la hoja de instrucciones de cada accesorio para obtener más información.

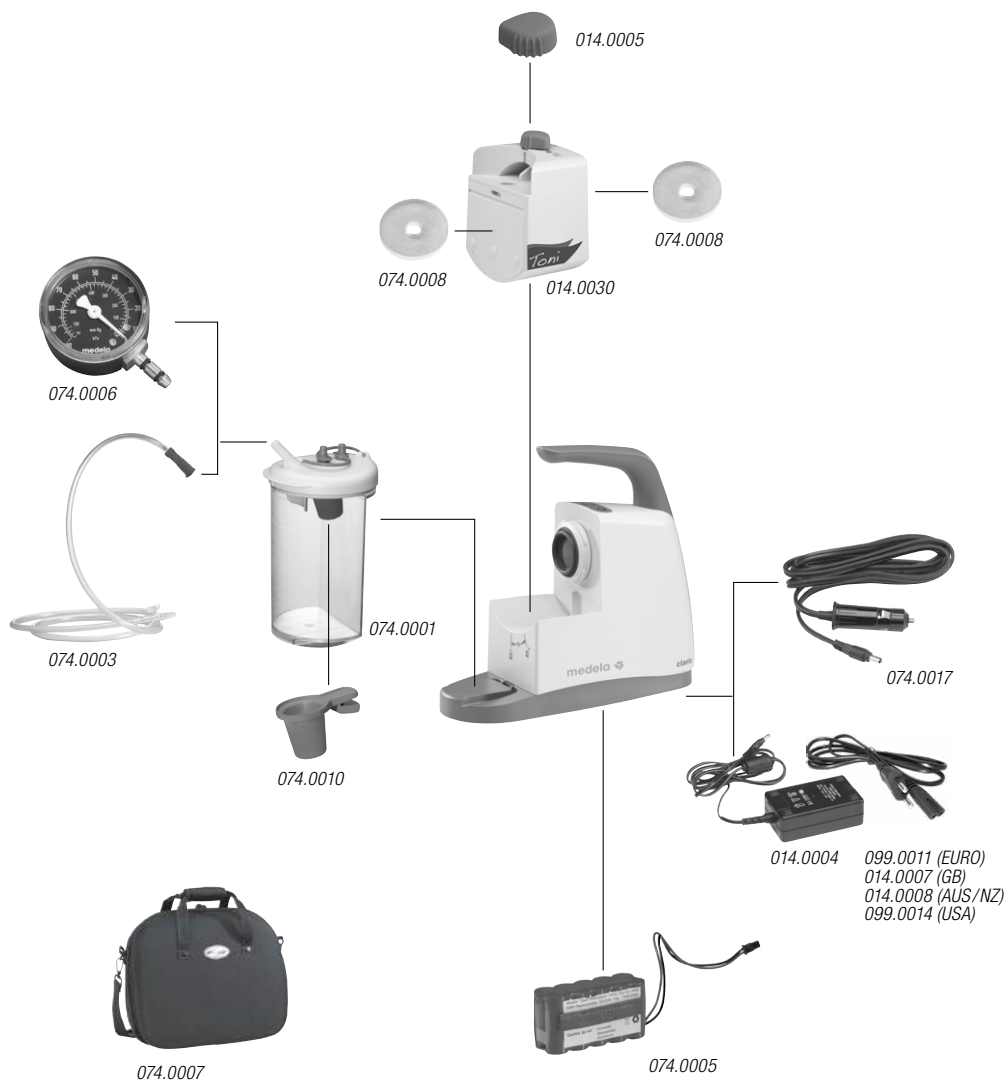

18 Lista completa de accesorios



Consejo de seguridad

Si el aspirador se utiliza con componentes distintos a los de Medela deben:

- disponer de marcado CE y, en caso necesario, de registro local.
- poder acoplarse a los accesorios de Medela de forma segura sin afectar al rendimiento del dispositivo.

Nota: al combinar piezas de Medela con otras piezas, la responsabilidad sobre el sistema completo pasa a ser suya.

REF

014.0030	Cámara de seguridad
014.0005	Regulador de vacío
074.0008	Discos de válvula (10 uds.)
074.0001	Juego de recipientes
074.0010	Flotador (10 uds.)
074.0003	Tubo de aspiración desechable
074.0005	Batería recargable
014.0004	Transformador
099.0011	Cable de alimentación (EURO)
099.0014	Cable de alimentación (USA)
014.0007	Cable de alimentación (GB)
074.0007	Bolsa
074.0017	Cable de conexión para el coche de 12 V CC
074.0006	Manómetro de vacío

19 Símbolos



Este símbolo indica el cumplimiento de los requisitos esenciales de la Directiva 93/42/CEE del Consejo de 14 de junio de 1993 relativa a los productos sanitarios.



Este símbolo indica la clase del aspirador.



Este símbolo indica que es un dispositivo de clase II.

IP21

Este símbolo indica protección contra cualquier efecto dañino producido por la entrada de objetos sólidos externos y contra los efectos dañinos por la entrada de agua.



Este símbolo indica el mes y el año tras el cual debe dejarse de utilizar el dispositivo.



Este símbolo acompaña a un dispositivo de un solo uso. No lo reutilice.



Este símbolo indica el número de catálogo del fabricante.



Este símbolo indica el número de serie del fabricante.



Este símbolo indica el código de lote del fabricante.



Este símbolo indica que el dispositivo se ha esterilizado mediante óxido de etileno.



Este símbolo indica el límite de temperatura de funcionamiento, transporte y almacenamiento.



Este símbolo recoge los límites de humedad para el funcionamiento, transporte y almacenamiento.



Este símbolo muestra el cumplimiento de requisitos adicionales de seguridad de EE. UU. y Canadá para los equipos eléctricos sanitarios.



Este símbolo indica las especificaciones legales del aspirador.



Este símbolo recomienda seguir las instrucciones de uso.



Este símbolo recomienda consultar las instrucciones de uso.



Este símbolo acompaña a una PRECAUCIÓN o ADVERTENCIA asociada al dispositivo.



Este símbolo acompaña a un consejo sobre seguridad.



Este símbolo acompaña a una pieza aplicada de tipo BF.



Este símbolo indica que NO ES SEGURO PARA RM.



Este símbolo indica posibles interferencias en las cercanías de equipos marcados con esta imagen.



Este símbolo indica el fabricante.



Este símbolo muestra la fecha de fabricación (cuatro dígitos para el año y dos para el mes).



Este símbolo muestra los límites de presión atmosférica para el funcionamiento, el transporte y el almacenamiento.



Este símbolo indica que no se debe utilizar el dispositivo si el embalaje se encuentra dañado.



Este símbolo indica el número de elementos suficientes para el contenido.



Este símbolo indica que el dispositivo no se debe desechar junto con los residuos municipales sin clasificar (solo UE).



Este símbolo indica que el material es parte de un proceso de recuperación / reciclaje.



Este símbolo acompaña a un embalaje de cartón.



Este símbolo recomienda mantener el dispositivo alejado de la luz solar.



Este símbolo recomienda tratar el dispositivo frágil con cuidado.



Este símbolo indica que hay que mantener el dispositivo seco.



Este símbolo muestra el nivel de vacío máximo del aspirador.



Este símbolo muestra los niveles de flujo del aspirador.



Este símbolo recoge las especificaciones eléctricas del aspirador.



Este símbolo indica corriente alterna.



Este símbolo indica corriente continua.



Este símbolo muestra el peso del aspirador.



Este símbolo indica las dimensiones (al. x an. x pr.) del aspirador.

R_x only

Este símbolo acompaña a un dispositivo por prescripción. PRECAUCIÓN: de acuerdo con la legislación federal de Estados Unidos, la venta de este dispositivo solo podrá realizarla un médico u otra persona a petición de un médico (solo aplicable a Estados Unidos).

pcs

Este símbolo indica el número de artículos.

20 Especificaciones técnicas



vacío mín., - 70 mmHg / - 9 kPa (+/- 20 mmHg / +/- 2.6 kPa)
vacío medio, - 115 mmHg / - 15 kPa (+/- 30 mmHg / +/- 4 kPa)
vacío máx., - 600 mmHg / - 80 kPa (- 90 mmHg / - 12 kPa)

Presión atmosférica (calculada a 0 m): 1013 hPa

Nota: los niveles de vacío pueden variar en función de la ubicación (metros sobre el nivel del mar, presión atmosférica y temperatura).



caudal bajo: 15 l/min. (+/- 10%)



2,0 kg / 4,4 lbs
Sin recipiente



100-240 V, 50-60 Hz
12 V, 3,4 A, NiMH
Transformador
UE48-120340SPA1



ISO 13485
93/42 CEE, clase IIa



al. x an. x pr.
223 x 255 x 95 mm

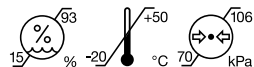

Condiciones de transporte
y almacenamiento



Transporte / almacenamiento
Batería recargable

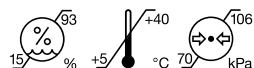

Condiciones de funcionamiento



IP21

21 Documentación técnica



ADVERTENCIA

No utilice accesorios distintos de los recomendados o vendidos por el fabricante como piezas de sustitución de componentes internos. Esto podría causar un aumento de las emisiones o disminuir la inmunidad del aspirador Clario Toni.

Los equipos quirúrgicos de HF (alta frecuencia), redes de radio o similares pueden afectar al funcionamiento del dispositivo y no se deben usar en combinación con el Clario Toni.

Compatibilidad electromagnética (CEM)

El aspirador Clario Toni ha superado las pruebas de CEM conforme a los requisitos de las normas CEI 60601-1-2:2007 y CEI 60601-1-2:2014, 4.ª edición, en lo relativo a las cláusulas 7 y 8.9. Clario Toni es un dispositivo médico sometido a medidas especiales de seguridad respecto a la CEM (compatibilidad electromagnética) y debe ser instalado y puesto en marcha de acuerdo con las informaciones adjuntas relativas a la CEM.

Consulte también las páginas 326–329.

Índice

Parabéns	292
1 Avisos e instruções de segurança	293
Instruções de segurança	295
2 Alimentação elétrica e operação a bateria	296
Bateria fraca	296
Bateria descarregada	296
3 Descrição	297
Introdução	297
Utilização prevista/Indicações	297
Contraindicações	297
Utilizador previsto	297
População de doentes prevista	297
Nota importante.....	297
4 Descrição Geral	298
Definição de vácuo	298
Versões do aspirador	298
Componentes principais do aspirador	298
Posição da membrana	299
Discos da válvula na Câmara de Segurança.....	299
Elementos de comando e indicadores do estado da bateria.....	299
5 Instalação	300
Verificação da entrega inicial	300
6 Preparação para utilização	301
Verificações antes da utilização.....	301
Montagem do recipiente.....	301
Montagem da Câmara de Segurança	302
Unir o recipiente ao aspirador	302
7 Instruções de funcionamento	303
Ligação do Clario Toni à alimentação elétrica	303
Verificação funcional com água.....	304
Alternativa: verificação funcional com o vacuómetro opcional.....	305
Alteração do nível de vácuo	306
Colocação fora de serviço após a utilização	306
8 Esvaziar o recipiente	307
9 Substituir os discos da válvula	308
10 Substituir a bateria recarregável	309
11 Dados e teste da bateria	310
Duração da aspiração	310

Tempo de carregamento (até ficar 100% carregado)	310
Estado da bateria	310
Teste da bateria recarregável	310
12 Calibragem da bateria	311
Calibragem da bateria NiNH recarregável	311
Armazenagem da bateria recarregável.....	311
13 Resolução de problemas	312
O motor não funciona.....	312
O aspirador faz demasiado ruído	312
Vácuo insuficiente.....	312
O tempo de funcionamento com a bateria é insuficiente.....	312
O LED não está aceso	312
O LED está aceso	312
O LED pisca lentamente	312
O LED pisca rapidamente	312
14 Garantia e manutenção	313
Garantia.....	313
Manutenção.....	313
15 Eliminação	313
16 Orientações de limpeza.....	314
Notas gerais	314
Agentes de limpeza de superfícies recomendados pela Medela para a caixa do aspirador.....	314
Água	314
Máquinas de limpeza/desinfecção	314
Produtos descartáveis.....	314
17 Descrição geral dos acessórios	316
18 Legenda dos acessórios	317
19 Sinais e símbolos	318
20 Especificações técnicas.....	320
21 Documentação técnica.....	321
21 Documentação técnica/CEM	322

Brazil

VR Medical Importadora e Distribuidora de Produtos Médicos Ltda
Rua Batataes nº 391, conjuntos 11, 13 e 8º andar – Jardim Paulista
São Paulo – SP – 01423-010

CNPJ: 04.718.143/0001-94

Resp. Técnica: Cristiane Aparecida de Oliveira Aguirre – CRF-SP 21.079

Registro ANVISA nº:

Parabéns

Ao escolher o Clario Toni, adquiriu um aspirador de secreções de elevada qualidade que se adapta às suas necessidades, a utilizar apenas por indicação de médicos/profissionais da saúde. O produto apresenta um desenho triplamente higiénico e excelente proteção contra extravasamento. Funciona por meio de um sistema de membrana com motor elétrico. Os 3 níveis de aspiração permitem a regulação da intensidade de aspiração de acordo com as necessidades do utilizador. Tal como sucede com todos os aspiradores de secreções da Medela, este dispositivo proporciona uma aspiração fiável e simples. O manuseamento e limpeza simples, bem como as propriedades de segurança, são vantagens adicionais que lhe são oferecidas. Contacte-nos – teremos todo o gosto em aconselhá-lo.

1 Avisos e instruções de segurança



AVISOS

Indicam uma situação potencialmente perigosa que, caso não seja evitada, poderá resultar em morte ou lesão grave.



NOTAS DE PRECAUÇÃO

Indicam uma situação potencialmente perigosa que, caso não seja evitada, poderá resultar numa lesão menor ou moderada.



Sugestão de segurança

Proporciona informações úteis acerca da utilização segura do dispositivo.

O Clario Toni está aprovado exclusivamente para a utilização descrita nestas instruções de utilização. A Medela só pode garantir o funcionamento seguro do sistema quando o Clario Toni for utilizado em combinação com os acessórios originais Medela. Consulte os capítulos 17/18.

Leia e observe estes avisos e instruções de segurança antes de colocar o dispositivo em funcionamento. Estas instruções de utilização devem ser conservadas para utilização futura.

Tenha em conta que estas instruções de utilização constituem uma orientação geral para o uso do produto. As questões médicas deverão ser solucionadas por um médico. A Medela considera-se a única responsável pelo efeito na SEGURANÇA BÁSICA, fiabilidade e desempenho do Clario Toni se este dispositivo for utilizado em conformidade com as Instruções de Utilização.

ATENÇÃO: A lei federal dos EUA só permite a venda deste dispositivo a médicos ou por indicação de um profissional de saúde.

Sujeito a alterações.



AVISOS

- Para utilização apenas por pessoal com formação médica e devidamente instruído nos procedimentos de aspiração e na utilização de aspiradores.
- Para os pacientes, nos quais a avaria do aparelho possa provocar uma situação crítica (p. ex., pacientes com dificuldade de respiração aguda ou mucosidade forte), é necessário estar disponibilizado um aparelho de substituição.
- O dispositivo não pode ser utilizado para aspirar líquidos explosivos, facilmente inflamáveis ou corrosivos.
- A tubagem de ligação fornecida com o dispositivo nunca pode entrar em contacto direto com a área de aspiração. É necessário utilizar um cateter de aspiração estéril em todas as ocasiões (risco de infeção).
- Antes de limpar o dispositivo, desligue a ficha da tomada de ligação à corrente.
- É proibida qualquer modificação deste equipamento.
- Não ligue este dispositivo a um tubo de drenagem passiva.
- Consulte as indicações de utilização e tenha em conta os fatores de risco e as contra-indicações antes de utilizar o Clario Toni. A não-leitura e a inobservância de todas as instruções incluídas neste manual antes da utilização podem resultar em lesões graves ou fatais para o doente.
- Não utilize o Clario Toni num ambiente de IRM (Imagiologia de Ressonância Magnética).
- A fonte de alimentação pode sofrer danos através da ocorrência de descarga eletrostática (ESD) na porta CC de 15 kV.



NOTAS DE PRECAUÇÃO

- A utilização incorreta pode causar dor e lesões no doente.
- Não utilize acessórios estéreis quando a embalagem estéril se apresentar danificada.
- Os equipamentos de comunicação sem fios, como, por exemplo, dispositivos numa rede doméstica sem fios, telemóveis, telefones sem fios e respetivas estações de base e walkie-talkies, podem afetar o funcionamento do Clario Toni, pelo que devem ser mantidos a uma distância mínima de 30 cm do equipamento.
- Os equipamentos portáteis e móveis de comunicações por radiofrequência podem afetar dispositivos médicos.



Sugestão de segurança

- Para testes de segurança, assume-se que o dispositivo seja sujeito a manutenção e reparado durante toda a sua vida útil, conforme o manual de manutenção. Em virtude de o Clario Toni se tratar de um dispositivo da classe de segurança II (EN IEC 60601-1, A1, A2:1995), os testes de segurança são limitados à inspeção visual da caixa e do cabo. Este teste tem de ser realizado antes de cada utilização.
- Teste da corrente de perda ao doente: Consulte o manual de manutenção para obter detalhes.
- A proteção do Clario Toni contra os efeitos da descarga de um desfibrilhador cardíaco depende da utilização dos cabos adequados.
- A separação da fonte de alimentação só é assegurada desligando a ficha de corrente da tomada de alimentação.
- Antes de ligar o dispositivo à tomada, verifique se a alimentação elétrica local corresponde à tensão indicada na placa de especificações.

Instruções de segurança

- O Clario Toni da Medela é um instrumento médico que exige medidas de segurança especiais relativamente à CEM. Deve ser instalado e colocado em funcionamento de acordo com a informação de CEM em anexo.
- Nos casos que se seguem, o dispositivo não deve ser colocado em funcionamento e tem de ser reparado pelo serviço pós-venda:
 - se o cabo ou a ficha de ligação à corrente estiverem danificados
 - se o dispositivo não estiver a funcionar perfeitamente
 - se o dispositivo estiver danificado
 - se o dispositivo apresentar defeitos de segurança evidentes.
- Mantenha o cabo de alimentação afastado de superfícies quentes.
- A ficha e o interruptor ON/OFF não devem entrar em contacto com humidade.
- Nunca desligue a ficha da tomada puxando pelo cabo de alimentação!
- Nunca deixe o dispositivo sem supervisão quando está ligado.
- Durante a utilização, o aspirador tem de estar na vertical.
- Nunca coloque o cabo de alimentação à volta do pescoço.
- Não usar, nunca, o dispositivo com temperaturas elevadas no quarto, no banho ou no chuveiro, se estiver muito cansado, nem em ambientes com risco de explosão.
- Não colocar, nunca, o dispositivo na água ou noutros líquidos.
- Ao utilizar produtos estéreis e de utilização única, tenha em conta que estes não se destinam a ser reaproveitados. O reaproveitamento pode causar a perda de características mecânicas, químicas e/ou biológicas. A reutilização pode causar contaminação cruzada.
- Contacte o representante local de apoio ao cliente da Medela para obter assistência nas operações com o produto.
- Utilize luvas sempre que utilizar o aparelho.

Estas instruções de utilização devem ser guardadas para referência futura.

2 Alimentação elétrica e operação a bateria

O Clario Toni é um aspirador de secreções alimentado a corrente e a bateria. Antes de ligar o dispositivo à tomada, verifique se a alimentação elétrica local corresponde à tensão indicada na placa de especificações. Utilizado como se descreve neste manual do utilizador, o Clario Toni modelo AC / DC apresenta um tempo máximo de funcionamento de 50 minutos a bateria antes de ser necessário recarregá-la. Caso o Clario Toni modelo AC / DC não esteja em uso, a bateria deve ser calibrada a cada 60–90 dias.

Bateria fraca

Durante a operação a bateria, o LED indicador a piscar lentamente indica que a bateria recarregável irá ficar descarregada em breve. O funcionamento do Clario Toni manter-se-á durante um curto período de tempo (~10 minutos), mas a bateria deverá ser recarregada logo que possível.

Bateria descarregada

Quando a bateria recarregável fica descarregada, o aspirador deixa de funcionar. O funcionamento adequado do aspirador deixa de ser mantido. A bateria recarregável tem de ser recarregada ou substituída.

3 Descrição

Introdução

O Clario Toni é um aspirador de secreções de elevada qualidade. O seu funcionamento é assegurado pelo comprovado sistema de membrana. Combina, idealmente, um manuseamento e uma limpeza fáceis com propriedades de segurança para garantir um funcionamento ótimo. Usar somente de acordo com as instruções do seu médico e depois de obter instruções por parte de médicos especialistas experientes.

Utilização prevista

As bombas de sucção Clario Toni destinam-se à aspiração e remoção de secreções, fluidos corporais e objetos estranhos das vias aéreas de um paciente ou de um sistema de suporte respiratório nas áreas nasal, faríngea e traqueal de pacientes pediátricos e adultos. Este aspirador é próprio para ser usado em casa, no hospital, no automóvel ou no exterior.

Indicações

A bomba de sucção Clario Toni está indicado para desobstruir as vias aéreas através do nariz, da boca ou de um tubo de traqueostomia.

Contraindicações

O aparelho não deve ser usado em aspirações prolongadas.

Utilizador previsto

O Clario Toni apenas deve ser operado por utilizadores com a formação adequada. Essas pessoas não devem ter deficiências auditivas nem sofrer de surdez, e devem dispor de uma acuidade visual adequada. A formação deve ser atualizada pelo menos uma vez por ano.

População de doentes prevista

O Clario Toni destina-se a ser utilizado apenas em doentes com as patologias descritas nas indicações de utilização.

Nota importante

A conformidade com as técnicas e os procedimentos cirúrgicos adequados é da responsabilidade do médico. Cada médico tem de avaliar a adequabilidade do tratamento, com base nos seus conhecimentos e experiência.

4 Descrição geral

Definição de vácuo

Na aplicação dispositivos de aspiração médica, o vácuo é normalmente indicado como a diferença (em números absolutos) entre a pressão absoluta e a atmosférica, ou como valores negativos em Kilopascal (kPa). Neste documento, a indicação de -10 kPa, por exemplo, refere-se sempre a um intervalo de pressão em kPa abaixo da pressão atmosférica ambiente (em conformidade com a norma EN ISO 10079:1999).

Versões do aspirador



Clario Toni AC/DC

Componentes principais do aspirador



Posição da membrana



Discos da válvula na Câmara de Segurança

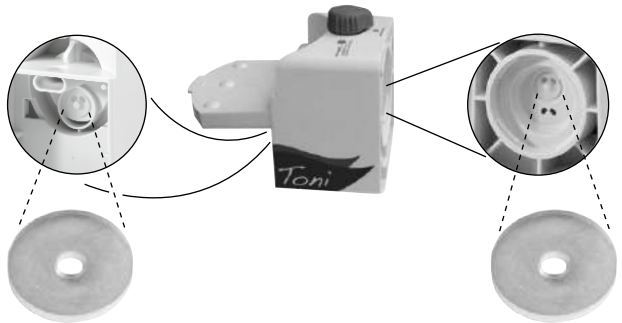

Elementos de comando e indicadores do estado da bateria

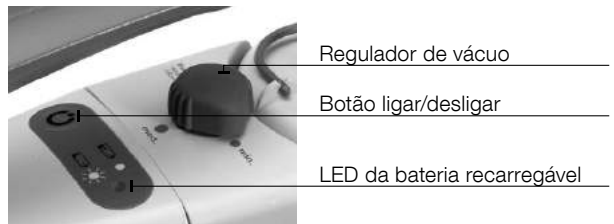

- apagado** Bateria totalmente carregada
- aceso**
 - Bateria em carregamento
 - Aspirador ligado à corrente
- a piscar lentamente** Bateria fraca
- a piscar rapidamente** Bateria avariada

5 Instalação

Verificação da entrega inicial

Verifique a embalagem de entrega do Clario Toni relativamente à presença e estado geral de todos os componentes.



Versões do Clario Toni

REF	Clario Toni AC/DC	014.00XX
	Clario Toni Deluxe	014.00XX



Tubagem com ponteira descartável

REF	074.0003
------------	----------



Adaptador de corrente

REF	014.0004
------------	----------

Cabo de alimentação

099.0011 (Euro)

014.0007 (UK)

014.0008 (AUS/NZ)

099.0014 (USA)



Instruções de utilização

REF	200.8400
------------	----------



AVISOS

A tubagem de ligação fornecida com o dispositivo nunca pode entrar em contacto direto com a área de aspiração. Deve ser sempre utilizado um cateter de aspiração estéril (risco de infeção).

6 Preparação para utilização



AVISOS

A ser utilizado apenas por pessoal com formação médica e devidamente instruído nos procedimentos de aspiração e na utilização de aspiradores. Utilize luvas sempre que utilizar o aparelho.



NOTAS DE PRECAUÇÃO

- Durante a utilização, o Clario Toni deve ser mantido na posição vertical.
- É necessário verificar a integridade da embalagem dos acessórios estéreis antes da utilização.
- Os acessórios não-estéreis e reutilizáveis têm de ser limpos, desinfetados e/ou esterilizados de acordo com o guia de limpeza da Medela (código do produto 200.2391).

6.1 Verificações antes da utilização

- Verifique o sistema Clario Toni antes da utilização para detetar danos no cabo de alimentação ou ficha, danos visíveis no dispositivo ou defeitos de segurança, bem como para verificar se o dispositivo funciona adequadamente.
- Verifique a embalagem de entrega do Clario Toni relativamente à sua presença e estado geral.
- Assegure-se de que a bateria recarregável se encontra calibrada de acordo com o capítulo 12.
- Verifique todos os acessórios antes da utilização:
 - Recipientes de aspiração e tampas quanto à presença de fissuras, pontos quebradiços e com falhas. Se necessário, substitua.
 - Verifique a tubagem, quanto à presença de fissuras e zonas quebradiças, e se os conectores estão fixados com firmeza. Se necessário, substitua.

6.2 Montagem do recipiente





- 1.1 Encaixe o flutuador no recipiente.

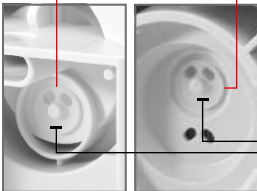

- 2.1 Coloque a tampa no recipiente. Oriente-se pelas marcas na frente do recipiente e na tampa.

6.3 Montagem da Câmara de Segurança

1.  1.1 Abra a tampa da Câmara de Segurança.
2.  2.1 Assegure-se de que ambas as válvulas (discos de silicone) se encontram ligadas à Câmara de Segurança. Consulte o capítulo 4.
3.  3.1 Assegure-se de que a tampa da Câmara de Segurança está bem fechada.
4.  4.1 Segurando na Câmara de Segurança, incline-a 45° para a esquerda, para a unir à unidade do motor.
4.2 Rode a Câmara de Segurança para uma posição vertical até ouvir um estalido.

6.4 Unir o recipiente ao aspirador

1.  1.1 Coloque o recipiente no aspirador. Prima com firmeza.
2.  2.1 Ligue a tubagem com ponteira descartável à porta de sucção.

7 Instruções de funcionamento



NOTAS DE PRECAUÇÃO

O Clario Toni deve ser configurado de forma a ser fácil proceder a uma separação da fonte de alimentação. Calibre a bateria recarregável antes da primeira utilização.



AVISOS

A ser utilizado apenas por pessoal com formação médica e devidamente instruído nos procedimentos de aspiração e na utilização de aspiradores. Utilize luvas sempre que utilizar o aparelho.

7.1 Ligação do Clario Toni à alimentação elétrica

1. Verifique o aspirador antes da utilização seguindo as instruções no capítulo 6.1.

2. **Todos os modelos: verifique se o aspirador está ligado a uma tomada elétrica fixa:**

Ligue a ficha do cabo de alimentação a uma tomada elétrica fixa.

OU

Verifique se o aspirador irá ser operado com uma fonte de alimentação 12V CC:

Ligue o cabo de ligação 12 V CC opcional ao aspirador e à fonte de alimentação de 12 V CC.

OU

Verifique se o aspirador irá ser operado com a bateria recarregável:

Não é necessário ligar a uma fonte de alimentação. Assegure-se de que a bateria foi carregada durante 5 horas.

7.2 Verificação funcional com água

1.

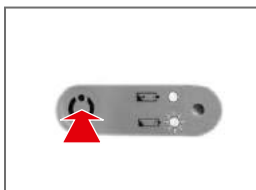

1.1 Prima o botão Ligar/Desligar para ligar o aspirador.

2.

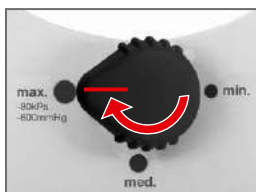

2.1 Defina o regulador do vácuo para a posição "max.".

3.

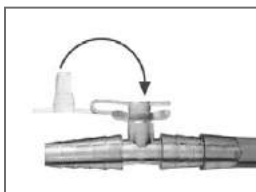

3.1 Ligue a tubagem com ponteira. Consulte o capítulo 6.4, passo 2.1.
3.2 Tape a porta da ponteira.

4.

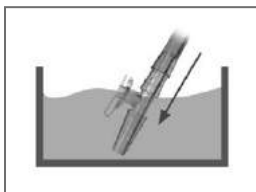

4.1 Coloque a ponteira em água e verifique se existe sucção.

5. Caso exista sucção, prossiga no passo 6. Caso não haja sucção, consulte o capítulo 13.

6. Utilize o cateter e as definições de vácuo prescritas pelo médico.

7.3 Alternativa: verificação funcional com o vacuómetro opcional



1.1 Ligue o vacuómetro opcional à porta de sucção.

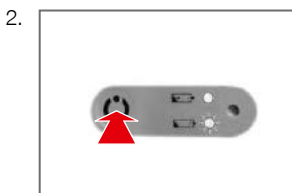

2.1 Prima o botão Ligar/Desligar para ligar o aspirador.

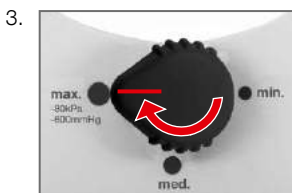

3.1 Defina o regulador do vácuo para a posição "max."

Altitude acima do nível do mar: Vácuo máximo:

+ 2000 m	- 63 kPa - 471 mmHg
+ 1000 m	- 71 kPa - 532 mmHg
+ 500 m	- 76 kPa - 566 mmHg
0 m	- 80 kPa - 600 mmHg

(Tolerância: - 15%)



4.1 Compare o vácuo máximo com os valores no quadro à esquerda.

5. Se o valor do vácuo estiver correto, prossiga no passo 6. Caso não haja sucção, consulte o capítulo 13.

6. Ligue a tubagem com ponteira.

7. Utilize o cateter e as definições de vácuo prescritas pelo médico.



AVISOS

A ser utilizado apenas por pessoal com formação médica e devidamente instruído nos procedimentos de aspiração e na utilização de aspiradores. Utilize luvas sempre que utilizar o aparelho.

7.4 Alteração do nível de vácuo

1.

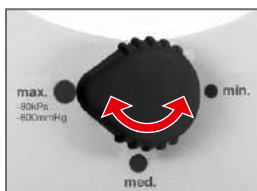

1.1 Ajuste o regulador de vácuo para a posição necessária.

7.5 Colocação fora de serviço após a utilização

1.

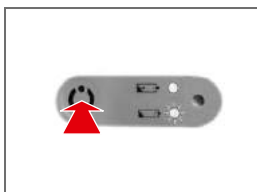

1.1 Prima o botão Ligar/Desligar para desligar o aspirador.

2. **Se o aspirador estiver ligado a uma tomada elétrica fixa:**

Desligue a ficha da tomada elétrica fixa.

ou

Se o aspirador estiver ligado a uma fonte de alimentação 12 V CC:

Desligue a ficha de 12 V CC da tomada de corrente de 12 V CC.





3. Limpe e desinfete o Clario Toni. Consulte o capítulo 16.

8 Esvaziar o recipiente



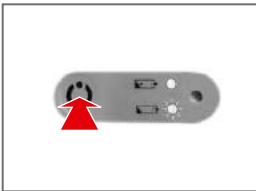

Sugestão de segurança

Diariamente, ou quando o nível de fluido atingir os 550 ml e o flutuador esteja a impedir que entre mais fluido no recipiente, este deve ser esvaziado.

1.  1.1 Prima o botão Ligar/Desligar para desligar o aspirador.
2.  2.1 Desligue a tubagem com ponteira descartável da porta de sucção.
2.2 Retire o recipiente do aspirador.
3.  3.1 Para transportar o recipiente, feche-o sempre com as tampas.
4. Esvazie o recipiente e elimine a tubagem com ponteira em conformidade com os regulamentos locais e as orientações internas.
5.  5.1 Coloque um recipiente limpo no aspirador.
5.2 Coloque uma nova tubagem com ponteira na porta de sucção.
6. Ligue o aspirador e regule o vácuo tal como prescrito pelo médico.

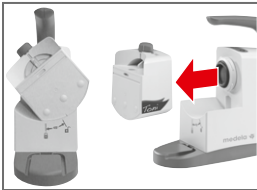
9 Substituir os discos da válvula

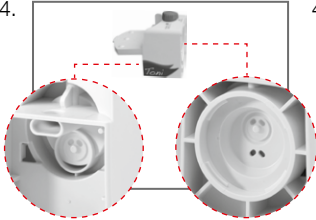
1.  1.1 Retire o recipiente.
2.  2.1 Incline a Câmara de Segurança 45° para a esquerda.
2.2 Retire a Câmara de Segurança levantando-a do aspirador.
3.  3.1 Abra a Câmara de Segurança.
4.  4.1 Substitua os discos da válvula defeituosos. Assegure-se de que os novos discos da válvula se encontram instalados corretamente.
5. Coloque a Câmara de Segurança de volta no aspirador como se descreve no capítulo 6.3.

10 Substituir a bateria recarregável



AVISOS

Antes de substituir a bateria recarregável, desligue o Clario Toni e retire a ficha do Clario Toni da tomada de alimentação fixa.

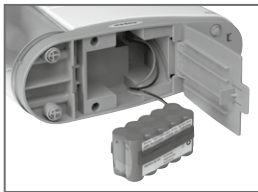
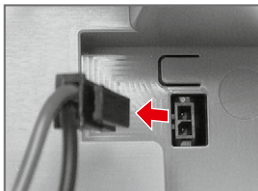
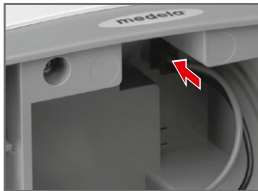

Antes de realizar esta operação, desligue a ficha da tomada de alimentação fixa.

1.  1.1 Abra a tampa do compartimento da bateria na parte inferior do Clario Toni.
2.  2.1 Desligue o cabo da bateria puxando pelo conector.
3. Retire a bateria recarregável antiga.
4. Introduza a nova bateria recarregável.
5.  5.1 Ligue o cabo da bateria inserindo o conector.
6. Feche a tampa do compartimento da bateria. Assegure-se de que a tampa fica bem fechada e que o cabo da bateria não fica dobrado nem entalado.
7. Calibrar e testar a bateria recarregável (ver capítulos 11/12).

11 Dados e teste da bateria



NOTAS DE PRECAUÇÃO

A bateria recarregável apenas deve ser recarregada quando o indicador de carga pisca lentamente.

Duração da aspiração

Caso a bateria esteja totalmente carregada, o tempo máximo de operação ao vácuo máximo é de aproximadamente > 50 minutos.

Tempo de carregamento (até ficar 100% carregado)

Aproximadamente 5 horas

Estado da bateria

apagado

Bateria totalmente carregada

aceso

- Bateria em carregamento
- Aspirador ligado à corrente

pisca lentamente

Bateria fraca

pisca rapidamente

Bateria avariada

Teste da bateria recarregável

1. Assegure-se de que a bateria recarregável se encontra totalmente carregada.
2. Desligue a ficha da tomada de alimentação.

3.

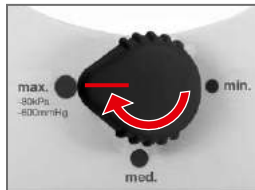

3.1 Defina o regulador do vácuo para a posição "max.".

4.

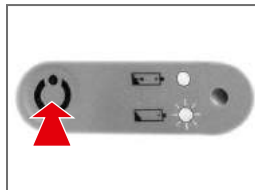

4.1 Ligue o Clario Toni. O aspirador começa a funcionar.

5. Determine o tempo de funcionamento até que o aspirador pare de funcionar. A bateria está ok quando o tempo de funcionamento é > 50 minutos.

Caso o tempo de funcionamento seja < 50 minutos, repita o teste ou calibre a bateria (ver página seguinte).

12 Calibragem da bateria



NOTAS DE PRECAUÇÃO

Calibre a bateria recarregável antes da primeira utilização e após um tempo de armazenamento > 2 meses. Substitua a bateria caso a calibragem não seja bem sucedida.

Calibragem da bateria NiMH recarregável

1. Assegure-se de que a bateria recarregável se encontra totalmente carregada.
2. Desligue a ficha da tomada de alimentação.

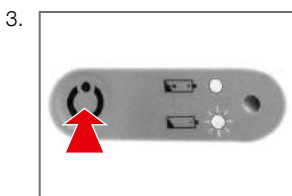

3.1 Ligue o Clario Toni. O aspirador começa a funcionar.

4. Deixe o aspirador a funcionar até que a bateria recarregável se encontre totalmente descarregada e o aspirador pare de funcionar.
5. Ligue o Clario Toni a uma tomada elétrica fixa. A bateria recarregável entra em carregamento.
6. Aguarde até que o indicador de carregamento se apague.
7. Repita os passos 1 a 6. O Clario Toni AC / DC está pronto a ser utilizado.

Armazenagem da bateria recarregável

Para manter a autodescarga no mínimo, guarde o Clario Toni e as baterias recarregáveis de substituição a temperaturas inferiores a 25 °C (77 °F). Repita o processo de calibragem a cada 60–90 dias.

13 Resolução de problemas

O motor não funciona

Verifique se:

- o Clario Toni está ligado.
- a tensão da corrente de alimentação é a correta e a ficha está corretamente inserida na tomada elétrica fixa.
- a bateria interna está carregada.

O aspirador faz demasiado ruído

Verifique a posição e a vedação dos discos da válvula no interior da Câmara de Segurança.

Vácuo insuficiente

Verifique se:

- o regulador de vácuo está ajustado corretamente.
- as tubagens não estão defeituosas ou quebradas. Se necessário, substitua.
- todas as ligações de encaixe estão bem colocadas e estanques.
- o recipiente/tampa não apresenta fissuras, zonas quebradiças, descoloração. Se necessário, substitua.
- os discos da válvula na Câmara de Segurança estão bem colocados.
- a membrana está limpa e não apresenta rasgões.

O tempo de funcionamento com a bateria é insuficiente

Proceda à calibragem da bateria recarregável. Consulte o capítulo 12.

O LED não está aceso

A bateria recarregável está totalmente carregada.

O LED está aceso

- A bateria recarregável está em carregamento.
- O aspirador está ligado à corrente.

O LED pisca lentamente

A bateria recarregável estará em breve descarregada. A potência da bateria é suficiente para cerca de 10 minutos de aspiração.

O LED pisca rapidamente

A bateria recarregável está avariada. Para substituir uma bateria defeituosa, consulte o capítulo 10.

14 Garantia e manutenção

Garantia

A Medela AG garante que o dispositivo estará isento de defeitos nos materiais e fabrico por um período de 2 anos (6 meses no caso da bateria recarregável) a partir da data de entrega. Durante esse período, o material com falhas será substituído gratuitamente se as mesmas não resultarem de uma utilização negligente ou de uma aplicação incorreta. Tal não se aplica às peças sujeitas a desgaste durante a utilização. Para garantir a conformidade com a presente garantia, bem como um desempenho ótimo da parte dos produtos da Medela, recomendamos a utilização exclusiva dos acessórios Medela com os nossos aparelhos.

A Medela AG não será, em circunstância alguma, responsável por reclamações que excedam o âmbito da garantia descrito, incluindo responsabilidade por danos consequenciais, etc.

A Medela não reconhecerá o direito à substituição de peças com falhas se pessoas não autorizadas tiverem realizado qualquer tipo de trabalho no aspirador. A presente garantia está sujeita à devolução do aparelho a um centro de assistência da Medela.

Manutenção

Os trabalhos de manutenção só devem ser realizados por pessoas autorizadas pela Medela. O manual de manutenção da Medela está disponível mediante pedido.

15 Eliminação

O Clario Toni contém metais e plásticos e deve ser eliminado de acordo com as Diretivas europeias 2011/65/CE e 2012/19/CE. Além disso, devem ser observados os regulamentos locais. Relativamente às versões AC/DC, os componentes eletrónicos e a bateria recarregável devem ser eliminados separadamente, de acordo com os regulamentos locais.

Certifique-se de que elimina o Clario Toni e os seus acessórios em conformidade com os regulamentos locais respeitantes à eliminação.



Informações para o utilizador relativas à eliminação de equipamento elétrico e eletrónico

Este símbolo significa que o equipamento elétrico e eletrónico não deve ser eliminado como resíduo doméstico comum. Uma eliminação correta deste dispositivo protege e previne possíveis danos para o ambiente ou a saúde humana. Para obter informações adicionais acerca da eliminação, contacte o fabricante, o prestador de cuidados local ou profissional de saúde. Este símbolo só é válido na União Europeia. Respeite as leis e os regulamentos relevantes em vigor no seu país para a eliminação de equipamento elétrico e eletrónico.

16 Orientações de limpeza



AVISOS

Após cada utilização, as peças que estiveram em contacto com as secreções aspiradas devem ser limpas, desinfetadas, esterilizadas ou eliminadas de **acordo com a tabela apresentada na página seguinte**.



Antes de limpar o dispositivo, desligue a ficha da tomada de alimentação fixa.

Notas gerais

- Estas são apenas recomendações gerais que poderão ser ajustadas individualmente, com base nas orientações específicas e práticas e políticas de limpeza do hospital.
- Informação detalhada de acordo com as instruções de limpeza Medela (código de produto 200.2391).
- Utilize luvas de proteção para limpar/desinfetar.
- Elimine os fluidos como sangue e secreções e as peças contaminadas com eles de acordo com as orientações internas do hospital.

Agentes de limpeza de superfícies recomendados pela Medela para a caixa do aspirador

- **CaviWipes**, Metrex Research, www.sybrondental.com
- **mikrozyd® AF wipes**, Schülke&Mayr GmbH, www.schuelke.com

Água

Utilize apenas água da mais pura qualidade para limpeza. A dureza da água é um fator obrigatório a ter em conta dado que os depósitos deixados em produtos médicos poderão não ser adequadamente descontaminados. Utilize água desionizada para diminuir este problema. A água de enxaguamento final deve ser isenta de bactérias não conter endotoxinas.

Máquinas de limpeza/desinfecção

Podem ser utilizadas para desinfetar peças com base no quadro apresentado na página seguinte. Um enxaguamento com água quente (temperatura máxima de 100 °C) pode proporcionar um nível de desinfecção médio a alto. Todas as secções das peças devem estar acessíveis para garantir uma limpeza eficaz. Recomendamos a utilização de uma máquina de limpeza/desinfecção que tenha sido aprovada pelo Robert Koch Institute e que esteja em conformidade com a norma ISO 15883. A temperatura recomendada para dispositivos médicos não-críticos (ou seja, aqueles que só entram em contacto com pele sem lesões) é de 90 °C durante 1 minuto. O tempo aumenta para 5 minutos no caso de todos os dispositivos médicos considerados críticos.



Produtos descartáveis

Estes são produtos de utilização única que não se destinam a ser reaproveitados. O reaproveitamento poderá causar a perda de características mecânicas, químicas e/ou biológicas. A reutilização pode causar contaminação cruzada.

Recipiente, Câmara de Segurança	Caixa do aspirador Cabo de alimentação	
x	x	<p>1. Desmontagem Separe todas as peças individuais antes da limpeza, desinfecção e esterilização.</p>
x		<p>2. Limpeza do recipiente, Câmara de Segurança Limpe os componentes em água quente (60–70 °C) com um detergente com um pH entre 6,0 e 8,0, por forma a evitar danificar os instrumentos e os dispositivos de contenção. Os detergentes enzimáticos ajudam a remover partículas orgânicas, tais como sangue. Os detergentes devem ser utilizados de acordo com os níveis de concentração recomendados pelo fabricante. Alguns detergentes alcalinos foram formulados para serem seguros para o reprocessamento de dispositivos médicos. Os fabricantes destes detergentes devem fornecer informações acerca dos materiais específicos que possam ser danificados pelos seus detergentes. Mantenha todas as peças submersas em água quente com sabão ou detergente enzimático durante 1 a 5 minutos.</p> <p>1. Elimine a sujidade visível com uma ferramenta de limpeza - escovas de limpeza multifunções, limpadores de tubagens ou panos sem pelo não-abrasivos. As escovas e os limpadores de tubagem devem encaixar mas terem ainda espaço para serem deslocados com facilidade no interior da zona a ser limpa. Enxague cuidadosamente em água limpa. Deixe secar.</p> <p>2. Inspeccione os instrumentos para a deteção de sujidade visível e, se necessário, repita estes passos.</p>
	x	<p>3. Limpeza da caixa da bomba, cabo de alimentação Limpe com o detergente indicado acima. Utilize um pano limpo para secar.</p>
x		<p>4. Desinfecção Deixe mergulhado numa solução de desinfecção/limpeza (A), à temperatura ambiente, durante 30 minutos. Após o tempo de reação, utilize água para enxaguar os resíduos da solução das peças individuais e para enxaguar a tubagem. Enxague durante pelo menos 2 minutos com a solução de limpeza (B).</p> <p>(A) Solução de desinfecção fluida sem aldeído com efeitos de limpeza para utilização como banho de imersão, bactericida, fungicida, virucida limitada, com boa compatibilidade material com aço inoxidável, material não-ferroso e plásticos, incluindo silicone, e ligeiramente alcalina como, por exemplo, neodisher® Septo MEDsolution a 2%.</p> <p>(B) Solução de limpeza enzimática fluida e com pH neutro para o tratamento de instrumentos por máquina ou manualmente com excelente compatibilidade material com aço inoxidável, material não-ferroso e plásticos, incluindo silicone.</p> <p>ou utilize uma máquina de limpeza/desinfecção. ou use uma máquina de lavar loiça.</p>
x		<p>5. Armazenagem dos componentes Depois da desinfecção, armazene os componentes sobre um pano limpo e seco.</p>

PT

17 Descrição geral dos acessórios



AVISOS

O Clario Toni foi verificado em combinação com os acessórios enumerados abaixo. Para um funcionamento correto e seguro, utilize o Clario Toni apenas com estes acessórios. A folha de instruções do acessório individual fornece informações adicionais.

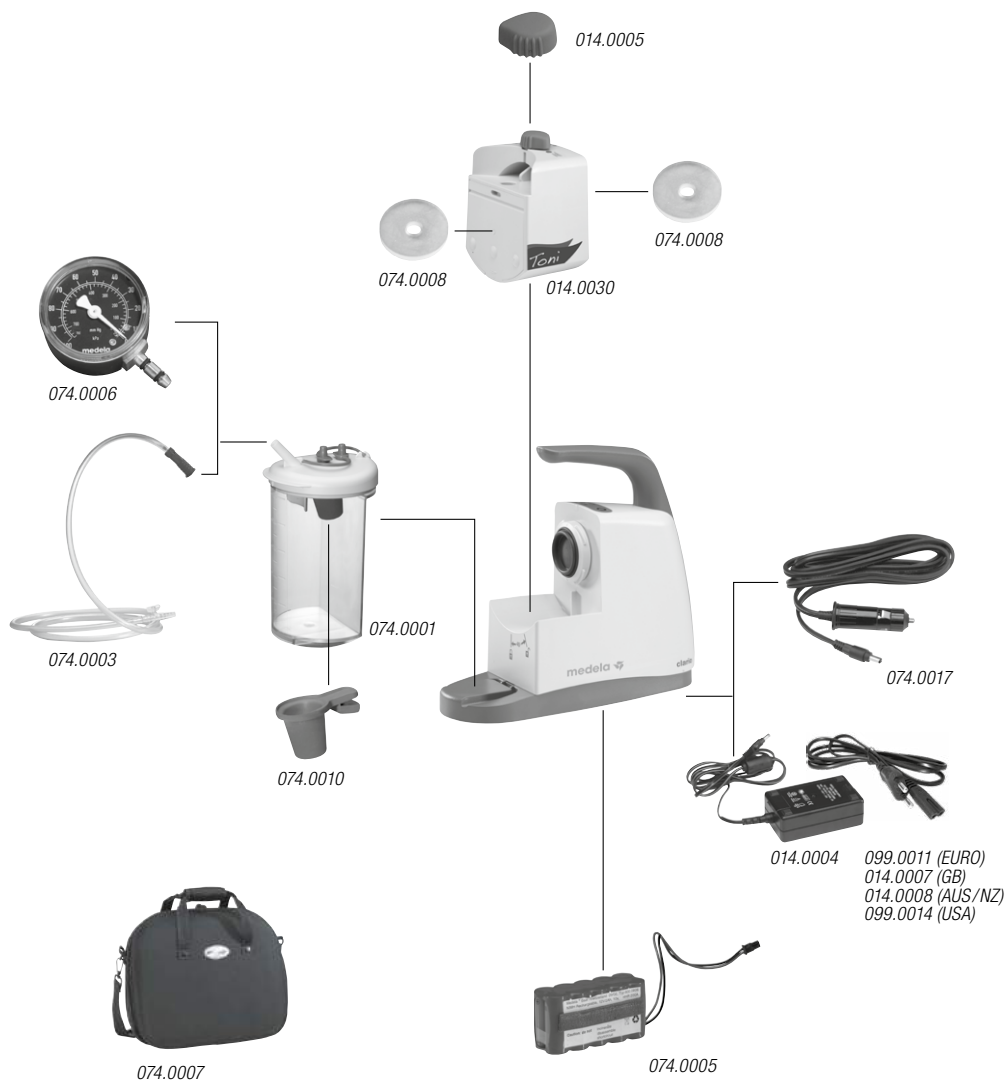

18 Legenda dos acessórios



Sugestão de segurança

Se o aspirador for utilizado em conjunto com peças aplicadas não provenientes da Medela, estas devem:

- apresentar a marca CE e (se necessário) o registo local
- poder ser fixadas de forma segura aos acessórios Medela sem qualquer impacto no desempenho do aspirador.

Nota: ao combinar peças Medela com peças não-Medela, o utilizador assume a responsabilidade pela totalidade do sistema.

REF

014.0030	Câmara de segurança
014.0005	Regulador de vácuo
074.0008	Discos da válvula (10 unidades)
074.0001	Conjunto de recipiente
074.0010	Flutuador (10 unidades)
074.0003	Tubagem com ponteira descartável
074.0005	Bateria recarregável
014.0004	Adaptador de corrente
099.0011	Cabo de alimentação (EURO)
099.0014	Cabo de alimentação (USA)
014.0007	Cabo de alimentação (GB)
074.0007	Mala de transporte
074.0017	Cabo de ligação para automóvel, 12 V CC
074.0006	Vacuómetro

19 Sinais e símbolos



Este símbolo indica a conformidade com os requisitos essenciais da Diretiva 93/42/CEE do Conselho, de 14 de Junho de 1993 relativa a dispositivos médicos.



Este símbolo indica a classe do aspirador.



Este símbolo indica um dispositivo de classe II.

IP21

Este símbolo indica a proteção contra os efeitos nocivos causados pela entrada de objetos sólidos estranhos e contra os efeitos nocivos causados pela entrada de água.



Este símbolo indica que o dispositivo não deve ser utilizado depois do final do ano e do mês indicados.



Este símbolo indica um dispositivo de utilização única. Não reutilize o dispositivo.



Este símbolo indica a conformidade com os requisitos de segurança adicionais dos EUA e do Canadá para equipamentos médicos elétricos.



Este símbolo indica o número de catálogo do fabricante.



Este símbolo indica o número de série do fabricante.



Este símbolo indica as especificações jurídicas do aspirador.



Este símbolo indica uma peça aplicada de tipo BF.



Este símbolo indica o código de lote do fabricante.



Este símbolo indica que é necessário seguir as instruções de utilização.



Este símbolo indica INSEGURO PARA RM.



Este símbolo indica que o dispositivo é esterilizado utilizando óxido de etileno.



Este símbolo indica que é necessário consultar as instruções de utilização.



Este símbolo indica que podem ocorrer interferências na proximidade do equipamento marcado com este símbolo.



Este símbolo indica a limitação da temperatura para funcionamento, transporte e armazenagem.



Este símbolo indica uma nota de ATENÇÃO ou AVISO associados ao dispositivo.



Este símbolo indica o fabricante.



Este símbolo indica a limitação da humidade para funcionamento, transporte e armazenagem.



Este símbolo indica uma sugestão relacionada com a segurança.



Este símbolo indica a data de fabrico (quatro dígitos para o ano e dois dígitos para o mês).



Este símbolo indica a limitação da pressão atmosférica para funcionamento, transporte e armazenagem.



Este símbolo indica que o dispositivo não deve ser utilizado caso a embalagem se encontre danificada.



Este símbolo indica o número de artigos n para o qual a embalagem é suficiente.



Este símbolo indica que o dispositivo não deve ser eliminado em conjunto com resíduos urbanos indiscriminados (apenas na UE).



Este símbolo indica que o material faz parte de um processo de recuperação/reciclagem.



Este símbolo indica uma embalagem de cartão.



Este símbolo indica que é necessário manter o dispositivo ao abrigo da luz do sol.



Este símbolo indica que é necessário manusear o dispositivo frágil com cuidado.



Este símbolo indica que é necessário manter o dispositivo seco.



Este símbolo indica o nível de vácuo máximo do aspirador.



Este símbolo indica os níveis de fluxo do aspirador.



Este símbolo indica as especificações elétricas do aspirador.



Este símbolo indica corrente alternada.



Este símbolo indica corrente contínua.



Este símbolo indica o peso do aspirador.



Este símbolo indica as dimensões (a x l x p) do aspirador.

R_{only}

Este símbolo indica um dispositivo a utilizar mediante prescrição médica. **ATENÇÃO:** A lei federal dos EUA só permite a venda deste dispositivo a médicos ou por indicação de um médico (apenas para os EUA).

pcs

Este símbolo indica o número de unidades (peças).

20 Especificações técnicas



vácuo mín., - 70 mmHg / - 9 kPa (+/- 20 mmHg / +/- 2.6 kPa)
vácuo méd., - 115 mmHg / - 15 kPa (+/- 30 mmHg / +/- 4 kPa)
vácuo máx., - 600 mmHg / - 80 kPa (- 90 mmHg / - 12 kPa)

Calculado a 0 m, pressão atmosférica: 1013 hPa
Nota: os níveis de vácuo podem variar em função da localização (metros acima do nível do mar, pressão atmosférica e temperatura).



fluxo reduzido: 15 l/min. (+/- 10%)



2,0 kg / 4,4 lbs
Sem recipiente



100-240 V, 50-60 Hz
12 V, 3,4 A, NiMH
Adaptador
UE48-120340SPA1



ISO 13485
93/42 CEE Classe IIa



a x l x p
223x255x95 mm

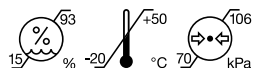

Condições de transporte
e armazenamento



Transporte/armazenagem
Bateria recarregável

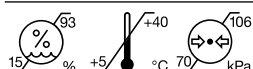

Condições de funcionamento



IP21

21 Documentação técnica



AVISOS

Não utilize outros acessórios além dos especificados ou vendidos pelo fabricante como peças de substituição para componentes internos dado que tal pode resultar num aumento das emissões ou diminuição da imunidade do aspirador Clario Toni.

O equipamento cirúrgico de alta frequência, as redes de rádio ou semelhantes podem afetar o funcionamento do dispositivo e não devem ser operados em combinação com o Clario Toni.

CEM

O Clario Toni foi testado quanto à CEM, em conformidade com os requisitos das normas IEC 60601-1-2:2007 e IEC 60601-1-2:2014, 4.ª Edição, de acordo com as cláusulas 7 e 8.9. O Clario Toni é um instrumento médico que exige medidas de segurança especiais relativamente à CEM e tem de ser instalado de acordo com as informações anexas sobre CEM.

Consulte também as páginas 322–325.

Compatibilidade eletromagnética

(CEM, IEC 60601-1-2:2007 3.ª Edição e IEC 60601-1-2 4.ª Edição, Tabela 1)

Emissões eletromagnéticas

O Clario Toni destina-se a ser utilizado no ambiente eletromagnético especificado abaixo.

O cliente ou o utilizador do Clario Toni deve assegurar que este é usado em tal ambiente.

Testes de emissão	Conformidade	Ambiente eletromagnético – orientação
Emissões de RF CISPR 11	Grupo 1	O Clario Toni utiliza energia de RF apenas para o seu funcionamento interno. Por conseguinte, as suas emissões de RF são muito reduzidas, e é pouco provável que provoquem interferência em equipamentos eletrónicos próximos.
Emissões de RF CISPR 11	Classe B	O Clario Toni é adequado para ser utilizado em todos os estabelecimentos, incluindo estabelecimentos domésticos e aqueles que estão ligados diretamente à rede pública de fornecimento de energia de baixa tensão, que alimenta edifícios para fins domésticos.
Emissões harmónicas IEC 61000-3-2	Classe A	
Flutuações de tensão/ emissões intermitentes IEC 61000-3-3	não aplicável	



AVISOS

O Clario Toni não deve ser utilizado contíguo ou empilhado com outros equipamentos. Se a utilização contígua ou empilhada for necessária, o Clario Toni deve ser observado para verificar o funcionamento normal na configuração em que será utilizado.

Imunidade eletromagnética

O Clario Toni destina-se a ser utilizado no ambiente eletromagnético especificado abaixo.
O cliente ou o utilizador do Clario Toni deve assegurar que este é usado em tal ambiente.

Testes de imunidade	IEC 60601 nível de teste	Nível de conformidade	Ambiente eletromagnético – orientação
Descarga eletrostática (ESD) IEC 61000-4-2	± 6kV contacto ± 8kV ar	± 6kV contacto ± 8kV ar	Os pavimentos devem ser de madeira, betão ou tijoleira de cerâmica. Se os pavimentos estiverem cobertos com material sintético, a humidade relativa deve ser de pelo menos 30%.
Transiente elétrico rápido IEC 61000-4-4	± 2kV para linhas de alimentação elétrica ± 1kV para linhas de entrada/saída	± 2kV para linhas de alimentação elétrica ± 1kV para linhas de entrada/saída	A qualidade da alimentação elétrica deve ser a de um ambiente comercial ou hospitalar típico.
Sobretensão IEC 61000-4-5	± 1kV linha(s) para linha(s) ± 2kV linha(s) para terra	± 1kV linha(s) para linha(s) ± 2kV linha(s) à terra não aplicável	A qualidade da alimentação elétrica deve ser a de um ambiente comercial ou hospitalar típico.
Buracos de tensão, breves interrupções e flutuações de tensão nas linhas de entrada de alimentação elétrica IEC 61000-4-11	<5% U_T (>95% queda em U_T) para 0,5 ciclo 40% U_T (60% queda em U_T) para 5 ciclos 70% U_T (30% queda em U_T) para 25 ciclos <5% U_T (>95% queda em U_T) durante 5 seg.	<5% U_T (>95% queda em U_T) para 0,5 ciclo 40% U_T (60% queda em U_T) para 5 ciclos 70% U_T (30% queda em U_T) para 25 ciclos <5% U_T (>95% queda em U_T) durante 5 seg.	A qualidade da alimentação elétrica deve ser a de um ambiente comercial ou hospitalar típico. Se o utilizador do Clario Toni necessitar de um funcionamento contínuo durante as interrupções na alimentação elétrica, recomenda-se que o Clario Toni seja alimentado por uma fonte de alimentação ininterrupta ou uma bateria.
Campo magnético da frequência da corrente elétrica (50/60Hz) IEC 61000-4-8	3A/m	3A/m	Os campos magnéticos da frequência da corrente elétrica devem estar a níveis de um ambiente comercial ou hospitalar típico.

Nota: U_T é a tensão da corrente alternada (CA) antes da aplicação do nível do teste.

Imunidade eletromagnética

O Clario Toni destina-se a ser utilizado no ambiente eletromagnético especificado abaixo. O cliente ou o utilizador do Clario Toni deve assegurar que o Clario Toni é usado em tal ambiente.

Testes de imunidade	IEC 60601 nível de teste	Nível de conformidade	Ambiente eletromagnético – orientação
RF conduzida IEC 61000-4-6	3Vrms 150kHz a 80MHz	3Vrms	Os equipamentos de comunicações RF portáteis e móveis não devem ser usados a uma distância do Clario Toni, incluindo os cabos, inferior à distância de separação recomendada, calculada a partir da equação aplicável à frequência do transmissor. Distância de separação recomendada $d = 1,2 \sqrt{P}$ $d = 1,2 \sqrt{P}$ 80MHz a 800MHz
RF irradiada IEC 61000-4-3	3V/m 80MHz a 2,5GHz	3V/m	$d = 2,3 \sqrt{P}$ 800MHz a 2,5GHz em que P é a potência máxima de saída do transmissor em watts (W) de acordo com o fabricante do transmissor e d é a distância de separação recomendada em metros (m) As intensidades de campo provenientes de transmissores RF fixos, conforme determinadas por uma inspeção eletromagnética do local, deverão ser menores do que o nível de conformidade para cada gama de frequência. ^b Poderão ocorrer interferências na proximidade do equipamento marcado com o seguinte símbolo: 

NOTA 1 A 80MHz e 800MHz, é aplicável a maior gama de frequência.

NOTA 2 Estas diretrizes poderão não ser aplicáveis a todas as situações. A propagação eletromagnética é afetada pela absorção e reflexão de estruturas, objetos e pessoas.

^a As intensidades de campo provenientes de transmissores RF fixos, tais como estações de base para radiotelefonos (telemóveis/sem fios), rádios móveis terrestres, rádio amador, emissões de radiodifusão AM e FM e televisão, não podem ser previstas com exatidão. Para avaliar o ambiente eletromagnético causado por transmissores RF fixos, deverá ser considerada uma inspeção eletromagnética do local. Se a intensidade de campo medida no local onde o Clario Toni está a ser utilizado exceder o nível de conformidade RF aplicável mencionado acima, será necessário verificar se o Clario Toni está a funcionar normalmente. Caso seja observado um funcionamento fora do normal, poderá ser necessário tomar medidas adicionais, tais como alterar a posição ou o local de instalação do Clario Toni.

^b Na gama de frequência de 150kHz a 80MHz, as intensidades de campo deverão ser inferiores a 3V/m.

Distância de separação recomendada entre equipamentos de comunicações RF portáteis e móveis e o Clario Toni

O Clario Toni destina-se a ser utilizado num ambiente eletromagnético em que as perturbações RF irradiadas são controladas. O cliente ou o utilizador do Clario Toni pode ajudar a evitar interferências eletromagnéticas, mantendo a distância mínima entre os equipamentos de comunicações RF portáteis e móveis (transmissores) e o Clario Toni, conforme recomendado abaixo, de acordo com a potência máxima de saída do equipamento de comunicações.

Potência máxima nominal de saída do transmissor	Distância de separação de acordo com a frequência do transmissor		
	150 kHz a 80 MHz $d = 1,2 \sqrt{P}$	80 MHz a 800 MHz $d = 1,2 \sqrt{P}$	800 MHz a 2,5 GHz $d = 2,3 \sqrt{P}$
W			
0,01	0,12	0,12	0,23
0,1	0,38	0,38	0,73
1	1,2	1,2	2,3
10	3,8	3,8	7,3
100	12	12	23

Para transmissores cuja potência máxima nominal de saída não está indicada acima, a distância de separação d recomendada em metros (m) pode ser calculada, utilizando a equação aplicável à frequência do transmissor, em que P é a potência máxima de saída do transmissor em watts (W) de acordo com o fabricante do transmissor.

NOTA 1 A 80 MHz e 800 MHz, é aplicável a distância de separação para a maior gama de frequência.

NOTA 2 Estas diretrizes poderão não ser aplicáveis a todas as situações. A propagação eletromagnética é afetada pela absorção e reflexão de estruturas, objetos e pessoas.

Electromagnetic Compatibility (EMC, IEC 60601-1-2:2007, 3rd Edition and IEC 60601-1-2:2014 4th Edition, Table 1)

Electromagnetic Emissions

Clario Toni is intended for use in the electromagnetic environment specified below. The customer or the user of Clario Toni should assure that they are used in such environment.

Emission Tests	Compliance	Electromagnetic environment – guidance
RF emissions CISPR 11	Group 1	Clario Toni uses RF energy only for its internal function. Therefore, its RF emissions are very low and are not likely to cause any interference with nearby electronic equipment.
RF emissions CISPR 11	Class B	Clario Toni is suitable for use in all establishments, including domestic establishments and those directly connected to the public low-voltage power supply network that supplies buildings used for domestic purposes.
Harmonic emissions IEC 61000-3-2	Class A	
Voltage fluctuations/ flicker emissions IEC 61000-3-3	Not applicable	



WARNINGS

Clario Toni should not be used adjacent to or stacked with other equipment. If adjacent or stacked use is necessary, Clario Toni should be observed to verify normal operation in the configuration in which it will be used.

Electromagnetic Immunity

Clario Toni is intended for use in the electromagnetic environment specified below. The customer or the user of Clario Toni should assure that they are used in such environment.

Immunity Tests	IEC 60601 test level	Compliance level	Electromagnetic environment – guidance
Electrostatic Discharge (ESD) IEC 61000-4-2	± 6 kV contact ± 8 kV air	± 6 kV contact ± 8 kV air	Floors should be wood, concrete or ceramic tile. If floors are covered with synthetic material, the relative humidity should be at least 30 %.
Electrical fast transient/burst IEC 61000-4-4	± 2 kV for power supply lines ± 1 kV for input / output lines	± 2 kV for power supply lines ± 1 kV for input / output lines	Mains power quality should be that of a typical commercial or hospital environment.
Surge IEC 61000-4-5	± 1 kV line(s) to line(s) ± 2 kV line(s) to earth	± 1 kV line(s) to line(s) ± 2 kV line(s) to earth not applicable	Mains power quality should be that of a typical commercial or hospital environment.
Voltage dips, short interruptions and voltage variations on power supply input lines IEC 61000-4-11	<5% U_T (>95 % dip in U_T) for 0.5 cycle 40% U_T (60% dip in U_T) for 5 cycles 70% U_T (30% dip in U_T) for 25 cycles <5% U_T (>95 % dip in U_T) for 5 sec	<5% U_T (>95 % dip in U_T) for 0.5 cycle 40% U_T (60% dip in U_T) for 5 cycles 70% U_T (30% dip in U_T) for 25 cycles <5% U_T (>95 % dip in U_T) for 5 sec	Mains power quality should be that of a typical commercial or hospital environment. If the user of Clario Toni requires continued operation during power mains interruptions, it is recommended that Clario Toni be powered from an uninterruptible power supply or a battery.
Power frequency (50/60 Hz) magnetic field IEC 61000-4-8	3 A/m	3 A/m	Power frequency magnetic fields should be at levels of a typical commercial or hospital environment.

Note: U_T is the a.c. mains voltage prior to application of test level.

Electromagnetic Immunity

Clario Toni is intended for use in the electromagnetic environment specified below. The customer or the user of Clario Toni should assure that Clario Toni is used in such environment.

Immunity Tests	IEC 60601 test level	Compliance level	Electromagnetic environment – guidance
Conducted RF IEC 61000-4-6	3 Vrms 150 kHz to 80 MHz	3 Vrms	<p>Portable and mobile RF communications equipment should be used no closer to any part of Clario Toni, including cables, than the recommended separation distance calculated from the equation applicable to the frequency of the transmitter.</p> <p>Recommended separation distance</p> $d = 1.2 \sqrt{P}$ $d = 1.2 \sqrt{P}$ <p>80 MHz to 800 MHz</p> $d = 2.3 \sqrt{P}$ <p>800 MHz to 2.5 GHz</p> <p>where P is the maximum output power rating of the transmitter in watts (W) according to the transmitter manufacturer and d is the recommended separation distance in meters (m)</p> <p>Field strengths from fixed RF transmitters, as determined by an electromagnetic site survey, should be less than the compliance level in each frequency range.^b</p> <p>Interference may occur in the vicinity of equipment marked with the following symbol:</p> 
Radiated RF IEC 61000-4-3	3 V/m 80 MHz to 2.5 GHz	3 V/m	

NOTE 1 At 80 MHz and 800 MHz, the higher frequency range applies.

NOTE 2 These guidelines may not apply in all situations. Electromagnetic propagation is affected by absorption and reflection from structures, objects and people.

^a Field strengths from fixed RF transmitters, such as base stations for radio (cellular/cordless) telephones and land mobile radios, amateur radio, AM and FM radio broadcast and TV broadcast cannot be predicted theoretically with accuracy. To assess the electromagnetic environment due to fixed RF transmitters, an electromagnetic site survey should be considered. If the measured field strength in the location in which Clario Toni are used exceeds the applicable RF compliance level above, Clario Toni should be observed to verify normal operation. If abnormal operation is observed, additional measures may be necessary, such as reorienting or relocating Clario Toni.

^b Over the frequency range 150 kHz to 80 MHz, field strengths should be less than 3 V/m.

Recommended separation distance between portable and mobile RF communications equipment and Clario Toni

Clario Toni is intended for use in an electromagnetic environment in which radiated RF disturbances are controlled. The customer or the user of Clario Toni can help prevent electromagnetic interference by maintaining a minimum distance between portable and mobile RF communications equipment (transmitters) and Clario Toni as recommended below, according to the maximum output power of the communications equipment.

Rated maximum output power of transmitter	Separation distance according to frequency of transmitter		
	150 kHz to 80 MHz $d = 1.2 \sqrt{P}$	80 MHz to 800 MHz $d = 1.2 \sqrt{P}$	800 MHz to 2.5 GHz $d = 2.3 \sqrt{P}$
W			
0.01	0.12	0.12	0.23
0.1	0.38	0.38	0.73
1	1.2	1.2	2.3
10	3.8	3.8	7.3
100	12	12	23

For transmitters rated at a maximum output power not listed above, the recommended separation distance d in meters (m) can be estimated using the equation applicable to the frequency of the transmitter, where P is the maximum output power rating of the transmitter in watts (W) according to the transmitter manufacturer.

NOTE 1 At 80 MHz and 800 MHz, the separation distance for the higher frequency range applies.

NOTE 2 These guidelines may not apply in all situations. Electromagnetic propagation is affected by absorption and reflection from structures, objects and people.

Notes



Medela AG
Lättichstrasse 4b
6341 Baar, Switzerland
www.medela.com

International Sales

Medela AG
Lättichstrasse 4b
6341 Baar
Switzerland
Phone +41 41 562 51 51
Fax +41 41 562 51 00
customer@medela.ch
www.medelahealthcare.com

Australia

Medela Australia Pty Ltd,
Medical Technology
3 Arco Lane,
Heatherton, Vic 3202
Australia
Phone +61 3 9552 8600
Fax +61 3 9552 8699
contact@medela.com.au
www.medelahealthcare.com.au

Canada

Medela Canada Inc.
4160 Sladeview Crescent Unit # 8
Mississauga, Ontario
L5L 0A1
Canada
Phone +1 905 608 7272
Fax +1 905 608 8720
info@medela.ca
www.medela.ca

China

Medela (Beijing)
Medical Technology Co., Ltd.
Unit M, 4F
No 1068 Wuzhong Road
Minhang District,
Shanghai 201103
P.R. of China
Phone +86 21 6236 8102
Fax +86 21 6236 8103
info@medela.cn
www.medela.cn

France

Medela France SAS
14 rue de la Butte Cordière
91154 Etampes Cedex
France
Phone +33 1 69 16 10 30
Fax +33 1 69 16 10 32
info@medela.fr
www.medela.fr

Germany & Austria

Medela Medizintechnik
GmbH & Co. Handels KG
Postfach 1148
85378 Eching
Germany
Phone +49 89 31 97 59-0
Fax +49 89 31 97 59 99
info@medela.de
www.medela.de

India

Medela India Private Limited
602-603 | 6th Floor,
JMD Megapolis | Sohna Road,
Sector – 48 | Gurgaon 122 001
India
Phone +91 124 4832069
Fax +91 124 4832066
info@medela.in
www.medela.in

Italy

Medela Italia Srl a socio unico
Via Turrini, 13-15 - Loc. Bargellino
40012 Calderara di Reno (BO)
Italy
Phone +39 051 72 76 88
Fax +39 051 72 76 89
info@medela.it
www.medela.it

Japan

Medela K.K.
G-Place Sasazuka 13F
2-26-2, Sasazuka, Shibuya-ku,
Tokyo 151-0037
Japan
Phone +81 3 3373 3454
Fax +81 3 3373 3457
info@medela.jp
www.medela.jp

Netherlands & Belgium

Medela Benelux BV
Jiltenwaard 31
5236 WB 's-Hertogenbosch
The Netherlands
Phone +31 73 690 40 40
Fax +31 73 690 40 44
info@medela.nl
info@medela.be
www.medela.nl
www.medela.be

Poland

Medela Polska Sp. z o.o.
Ul. Lewinowska 8
PL-03-684 Warszawa
Poland
Phone +48 22 865 12 50
Fax +48 22 864 38 65
info@medela.pl
www.medela.pl

Russia

OOO Medela
Vavilova str. 97, entrance 3
Office 16-17
117335 Moscow
Russia
Phone +7 495 980 6194
Fax +7 495 980 6194
info@medela.ru
www.medela.ru

Spain & Portugal

Productos Medicinales Medela, S.L.
C/ Llacuna, 22 4ª Planta
08005, Barcelona
Spain
Phone +34 93 320 59 69
Fax +34 93 320 55 31
info@medela.es
www.medela.es
info@medela.pt
www.medela.pt

Sweden

Medela Medical AB
Box 7266
187 14 Täby
Sweden
Phone +46 8 588 03 200
Fax +46 8 588 03 299
info@medela.se
www.medela.se

Switzerland

Medela AG
Lättichstrasse 7
6341 Baar
Switzerland
Phone +41 848 633 352
Fax +41 41 562 14 42
contact@medela.ch
www.medela.ch

United Kingdom

Medela UK Ltd.
Huntsman Drive
Northbank Industrial Park
Irlam, Manchester M44 5EG
United Kingdom
Phone +44 161 776 0400
Fax +44 161 776 0444
info@medela.co.uk
www.medelahealthcare.co.uk

USA

Medela LLC
1101 Corporate Drive
McHenry, IL 60050
USA
Phone +1 877 735 1626
Fax +1 815 307 8942
info-healthcare@medela.com
www.medelahealthcare.us